

STRUTTURA Realizzata in legno abbinato a particelle di legno grezzo biodegradabile e pannelli di fibra di legno duro.

IMBOTTITURE Cuscini di seduta, braccioli, poggiatesta e spalliere poggiatesta reclinabili sono realizzate in poliuretano espanso a densità differenziate. Tutte le parti sopraelencate sono ricoperte da una termofalda di dacron autoestinguente. Cuscini di seduta: strato superiore: densità 30 kg/mc. Strato inferiore: densità 35 kg/mc. Termofalda da 450 gr/mq.

Braccioli e poggiatesta: densità 25 kg/mc. Termofalda da 350 gr/mq.

Spalliere poggiatesta: densità 25 kg/mc. Termofalda da 450 gr/mq.

Imbottiture di completamento: densità 21 kg/mc.

RIVESTIMENTO Pelle o microfibra non sfoderabile. Per le caratteristiche del rivestimento e della manutenzione vedere relative schede tecniche.

PIEDI Struttura in acciaio lucidato, H alla base del divano: cm 12,5

NOTE La versione standard del modello ha le sedute fisse. In opzione è possibile richiedere il modello provvisto di meccanismi scorrevoli applicati alle sedute, le quali, con il semplice movimento del corpo in avanti aumentano la profondità di seduta e la adattano a diverse esigenze di comfort. N.B.: Nel caso di richiesta di sedute scorrevoli, non è possibile produrre sullo stesso divano una sola seduta scorrevole. Sull'elemento angolo poltrona penisola sx-dx non è possibile inserire il meccanismo di seduta scorrevole. Gli schienali sono dotati di meccanismo manuale a cricchetto, reclinabili a seconda del comfort desiderato.

FRAME Hard wood combined with plywood and particle board covered with a dacron layer.

PADDING Seat cushion, backrest, kidney rest and armrest: double density polyurethane foam covered with a Dacron layer.
Seat cushion: bottom part 35kg/m3, upper part 30 kg/m3. Dacron layer: 450 gr/m2.

Armrest and kidney rest: 25 kg/m3. Dacron layer: 350 gr/m2

Backrest cushion 25kg/m3. Dacron layer: 450 gr/m2

COVERING Leather, microfiber or fabric. Not removable.

FEET Chromium-plated steel structure. Height: 12.5 cm

NOTE Model available with fixed or sliding seats. Both the seats of a sofa must be fixed or sliding. Option with one sliding seat and one fixed seat is not available. Version 0763/0762 is available only with fixed seat.

STRUCTURE En bois massif, multiples et particules habillées d'une couche de dacron.

REMBOURRAGE Coussins d'assise, accoudoirs, cale-reins et appuie-tête réalisés en polyuréthane écologique avec double densité recouvert avec une couche de dacron.

REVÊTEMENT Cuir, microfibre ou tissu non déhoussable.

ASSISE Partie inférieure: 35 kg/m3. Partie supérieure: 30kg/m3. Couche de dacron 450 gr/m2

Accoudoir et cale-reins : 25 kg/m3 Dacron : 350 gr/m2

Appuie-tête: 25 kg/m3 Dacron: 450 gr/m2

PIEDS Base en acier chromé. Hauteur 12.5 cm.

NOTE Modèle disponible avec assise fixe ou coulissante. Il n'est pas possible de produire un canapé avec une assise fixe et une assise coulissante. Les versions 0763/0762 ne sont pas disponibles avec assises coulissantes.

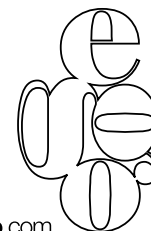
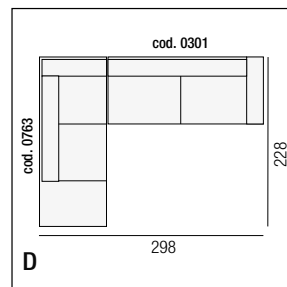
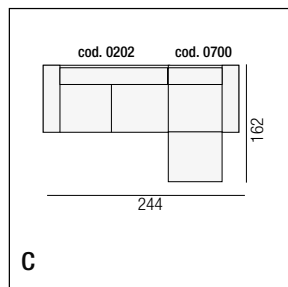
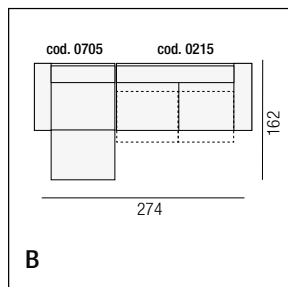
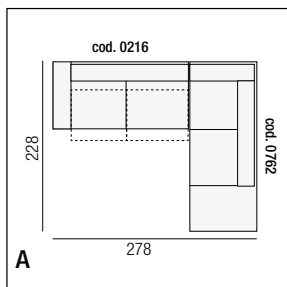
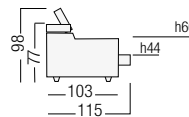
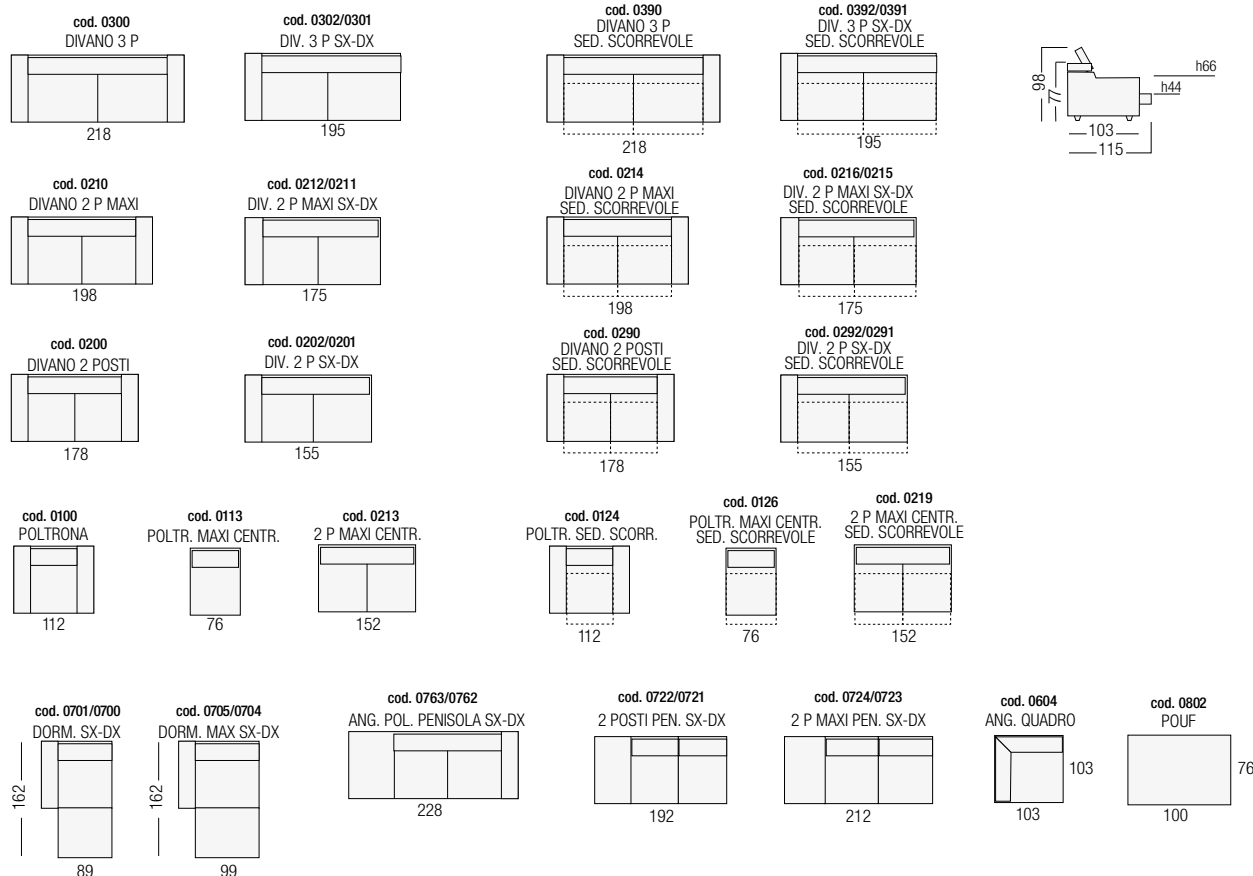

STRUTTURA Realizzata in legno abbinato a particelle di legno grezzo biodegradabile e pannelli di fibra di legno duro.

IMBOTTITURE Cuscini di seduta, braccioli, poggiatesta e spalliere poggiatesta reclinabili sono realizzate in poliuretano espanso a densità differenziate. Tutte le parti sopraelencate sono ricoperte da una termofalda di dacron autoestinguente. Cuscini di seduta: strato superiore: densità 30 kg/mc. Strato inferiore: densità 35 kg/mc. Termofalda da 450 gr/mq.

Braccioli: densità 35 kg/mc. Termofalda da 200 gr/mq.

Poggiatesta: densità 25 kg/mc. Termofalda da 350 gr/mq.

Spalliere poggiatesta: densità 25 kg/mc. Termofalda da 450 gr/mq.

Imbottiture di completamento: densità 21 kg/mc.

RIVESTIMENTO Pelle o microfibra non sfoderabile. Per le caratteristiche del rivestimento e della manutenzione vedere relative schede tecniche.

PIEDI Struttura in acciaio lucidato, H alla base del divano: cm 12,5

NOTE La versione standard del modello ha le sedute fisse. In opzione è possibile richiedere il modello provvisto di meccanismi scorrevoli applicati alle sedute, le quali, con il semplice movimento del corpo in avanti aumentano la profondità di seduta e la adattano a diverse esigenze di comfort. N.B.: Nel caso di richiesta di sedute scorrevoli, non è possibile produrre sullo stesso divano una sola seduta scorrevole. Sull'elemento angolo poltrona penisola sx-dx non è possibile inserire il meccanismo di seduta scorrevole. Gli schienali sono dotati di meccanismo manuale a cricchetto, reclinabili a seconda del comfort desiderato.

FRAME Hard wood combined with plywood and particle board covered with a dacron layer.

PADDING Seat cushion, backrest, kidney rest and armrest: double density polyurethane foam covered with a Dacron layer.

Seat cushion: bottom part 35kg/m3, upper part 30 kg/m3. Dacron layer: 450 gr/m2.

Armrest: 35 kg/m3. Dacron layer: 200 gr/m2

Kidney rest: 25 kg/m3. Dacron layer: 350 gr/m2

Backrest cushion 25kg/m3. Dacron layer: 450 gr/m2

COVERING Leather, microfiber or fabric. Not removable.

FEET Chromium-plated steel structure. Height: 12.5 cm

NOTE Model available with fixed or sliding seats. Both the seats of a sofa must be fixed or sliding. Option with one sliding seat and one fixed seat is not available.

Version 0763/0762 is available only with fixed seat.

STRUCTURE En bois massif, multiplis et particules habillés d'une couche de dacron.

REMBOURRAGE Coussins d'assise, accoudoirs, cale-reins et appuie-tête réalisés en polyuréthane écologique avec double densité recouvert avec une couche de dacron.

REVÊTEMENT Cuir, microfibre ou tissu non déhoussable.

ASSISE Partie inférieure: 35 kg/m3. Partie supérieure: 30kg/m3. Couche de dacron 450 gr/m2

Accoudoir: 35 kg/m3 Dacron : 200 gr/m2

Cale-reins : 25 kg/m3 Dacron : 350 gr/m2

Appuie-tête: 25 kg/m3 Dacron: 450 gr/m2

PIEDS Base en acier chromé. Hauteur 12.5 cm.

NOTE Modèle disponible avec assise fixe ou coulissante. Il n'est pas possible de produire un canapé avec une assise fixe et une assise coulissante. Les versions 0763/0762 ne sont pas disponibles avec assises coulissantes.

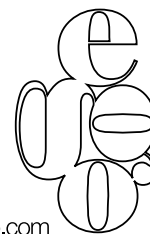
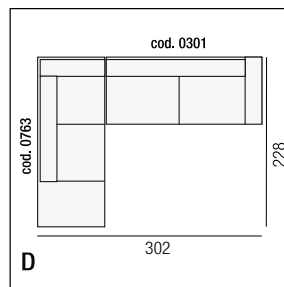
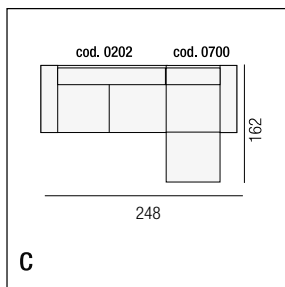
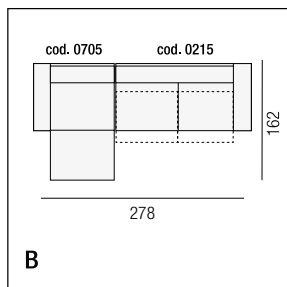
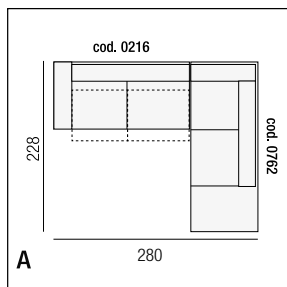
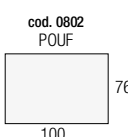
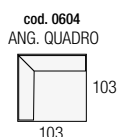
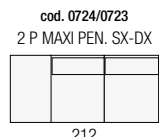
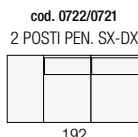
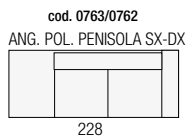
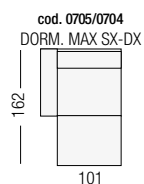
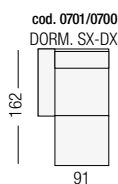
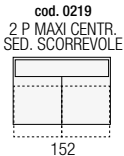
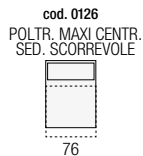
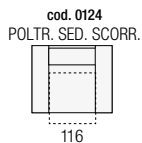
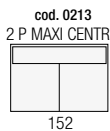
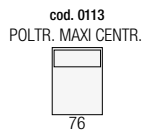
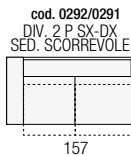
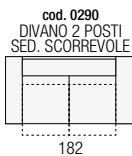
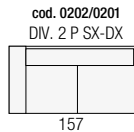
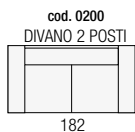
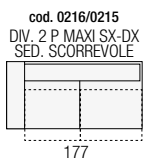
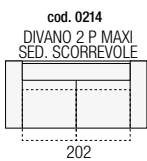
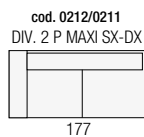
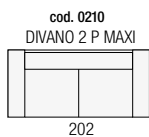
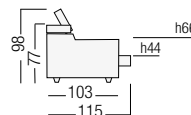
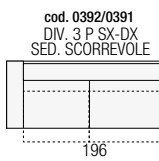
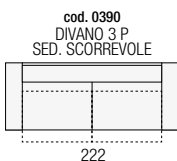
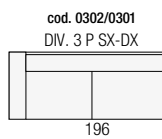
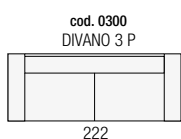

RIVESTIMENTO Pelle o microfibra non sfoderabile. Per le caratteristiche del rivestimento e la manutenzione vedere relative schede tecniche.

IMBOTTITURA Cuscini di seduta e braccioli in poliuretano espanso ecologico a densità differenziata. Cuscini di seduta di densità 30 kg/mc ricoperti con falda di dacron resinato da 100 gr/mq. Cuscini schienali realizzati in fibra di poliestere siliconata in fiocchi. Braccioli di densità 22 Kg/mc ricoperti da una termofalda di dacron autoestingente da 350 gr/mq.

PIEDI In Legno massello di faggio evaporato tinto con vernici ecologiche ad acqua, nei colori: Noce brunito, Wengé. H 4 cm.

STRUTTURA Realizzata in legno abbinato a particelle di legno grezzo biodegradabile e pannelli di fibra di legno duro.

RETE due pieghe elettrosaldata (3 POSTI 150x186), (2 P MAX 120x186).

MATERASSO a molle, optional in poliuretano espanso (3 POSTI 130x180x12), (2 P MAX 100x180x12).

NOTE Nella versione relax il modello è realizzato con meccanismo combinato con movimento schienale poggiatesta. Disponibile sia manuale che elettrico con comando posizionato sul bracciolo laterale. L'elemento relax è sempre staccato da quello fisso e viene agganciato con apposito sistema a baionetta.

COVERING Leather, microfiber or fabric. Not removable.

PADDING Seat cushion 30kg/m3 covered with a dacron layer 100gr/m2

Armrest 22kg/m3 covered with dacron layer 350gr/m2

Backrest cushion: siliconed polyester fibre

FEET Beech feet color dark walnut, wengé. H4cm

FRAME Hard wood combined with plywood and particle board covered with a dacron layer.

BASE Electro-welded 2-ply (3 seater 150x186cm, 2 seater maxi 120x186cm)

MATTRESS Spring, polyurethane on demand (3 seater 130x180x12cm, 2 seater maxi 100x180x12cm)

NOTE Manual and electric recliner available.

RENETEMENT Cuir, microfibre ou tissu non déhoussable.

REMBOURRAGE Coussins d'assise et accoudoirs: polyuréthane écologique à densité différenciée. Coussins d'assise: 30kg/m3 recouverts d'une couche de Dacron résiné 100gr/m2. Dossiers: flocons de mousse. Accoudoirs: densité 22kg/m3 recouverts d'une couche de dacron 350gr/m2.

PIED hêtre massif, vernis écologiques: noyer bruni ou Wengé. H 4cm.

STRUCTURE Bois recouvert d'une couche de dacron.

SOMMIER Electro-soudé à 2 plis (3 places 150x186, 2p.max 120x186).

MATELAS À ressorts, sur demande en polyuréthane (3 places 130x180x12, 2p.max 100x180x12).

NOTE Dans la version relax le modèle est réalisé avec un mécanisme combiné dossier/repouse-pieds. Disponible en manuel ou électrique avec commande sur l'accoudoir. L'élément relax est toujours détaché du fixe et est attaché à ce dernier par un système spécifique à baionette.

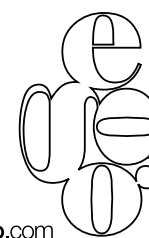
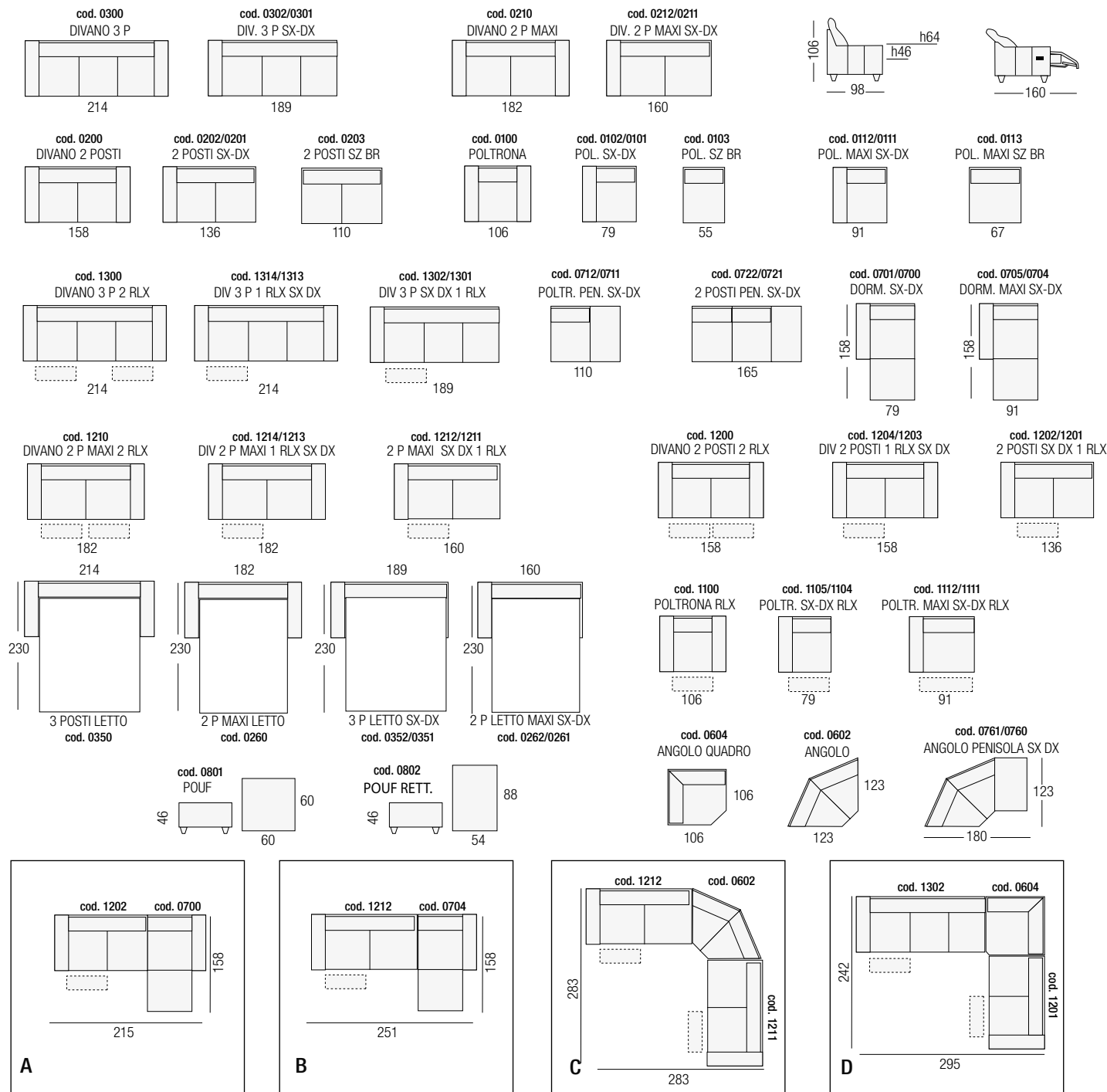

STRUTTURA Realizzata in legno abbinato a particelle di legno grezzo biodegradabile e pannelli di fibra di legno duro.

IMBOTTITURE Cuscini di seduta, braccioli, poggiatesta e spalliere poggiatesta reclinabili sono realizzate in poliuretano espanso a densità differenziate. Tutte le parti sopraelencate sono ricoperte da una termofalda di dacron autoestinguente. Cuscini di seduta: strato superiore: densità 30 kg/mc. Strato inferiore: densità 35 kg/mc. Termofalda da 450 gr/mq.

Braccioli e poggiatesta: densità 30 kg/mc. Termofalda da 450 gr/mq. Spalliere poggiatesta: densità 30 kg/mc. Termofalda da 450 gr/mq.

Imbottiture di completamento: densità 21 kg/mc.

RIVESTIMENTO Pelle o microfibra non sfoderabile. Per le caratteristiche del rivestimento e della manutenzione vedere relative schede tecniche.

PIEDI Struttura in ABS cromato, H : cm 4

NOTE Gli schienali sono dotati di meccanismo manuale a cricchetto, reclinabili a seconda del comfort desiderato.

NOTE SU RIVESTIMENTO La variante con cucitura in cordoncino è possibile solo su rivestimento in pelle cat.B e cat.C

COVERING Leather or microfiber. Not removable.

PADDING Seat cushion, backrest, kidney rest and armrest: double density polyurethane foam covered with a Dacron layer.

SEAT CUSHION bottom part 35Kg/m3, upper part 30Kg/m3. Dacron layer: 450 gr/m2. Armrest and kidney rest: 30Kg/m3. Dacron layer: 450 gr/m2.

Backrest cushion 30 Kg/m3. Dacron layer: 450 gr/m2.

FEET Chromium-plated ABS plastic. Height: 4cm.

FRAME Hard wood combined with plywood and particule board covered with a dacron layer.

NOTE Adjustable headrest.

Thick thread stitching available only with leather cat.B and cat.C

REVÊTEMENT Cuir ou microfibre non déhoussable.

REMBOURRAGE Coussins d'assise, cale-reins, accoudoirs et appuie-tête réclinables réalisés en polyuréthane écologique à double densité recouvert avec une couche de dacron. Assise: Partie inférieure: 35 Kg/m3. Partie supérieure 30 Kg/m3. Couche de dacron 450 gr/m2. Accoudoirs et cale-reins: 30 Kg/m3. Dacron 450 gr/m2 Appuie-tête: 30 Kg/m3. Dacron 450 gr/m2

Rembourrage de completamento: 21 Kg/m3

PIED ABS chromé, hauteur 4 cm

STRUCTURE En bois massif, multiplis et particules habillés d'une couche de dacron.**NOTE** Les dossiers sont équipés d'un mécanisme manuel au niveau des appuie-tête, réclinables selon le confort désiré.

Couture avec fil épais disponible seulement sur les cuirs cat. B et C

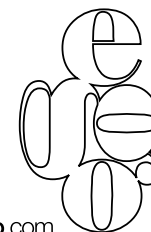
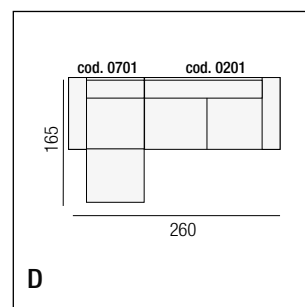
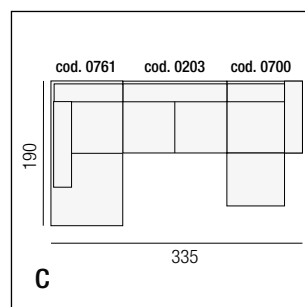
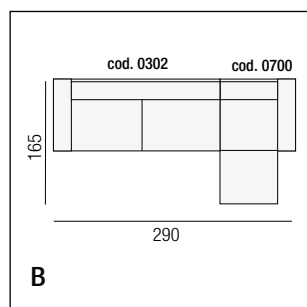
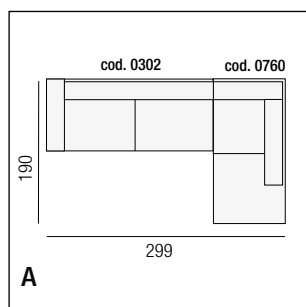
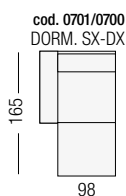
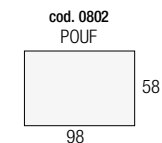
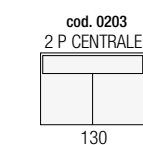
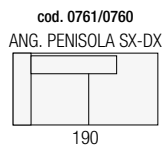
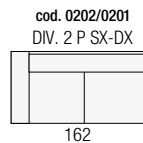
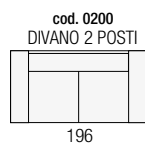
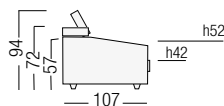
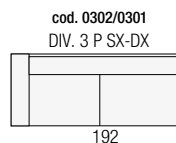
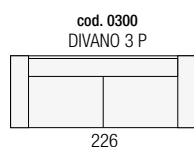

RIVESTIMENTO Pelle o microfibra, non sfoderabile. Per le caratteristiche del rivestimento e la manutenzione, vedere relative schede tecniche.

IMBOTTITURA Cuscino di seduta realizzato in poliuretano espanso di densità 30 kg/mc ricoperto da una falda di dacron da 450 gr/mq. Schienali realizzati in poliuretano espanso di densità 18 kg/mc ricoperti da una falda di dacron da 450 gr/mq. Braccioli realizzati in poliuretano espanso di densità 30 kg/mc ricoperto da una falda di dacron da 450 gr/mq con un inserto in dacron da 200 gr/mq. Poggiatesta realizzato in poliuretano espanso a densità differenziata da 18 kg/mc e 30 kg/mc, ricoperto da una falda di dacron da 450 gr/mq. Imbottiture di completamento in poliuretano espanso di densità 21 kg/mc.

PIEDI In acciaio cromato, h 4,5 cm.

STRUTTURA Realizzata in legno abbinato a particelle di legno grezzo biodegradabile e pannelli di fibra di legno duro.

NOTE Gli schienali sono dotati di meccanismi manuali con cricchetti a scatti, reclinabili a seconda del comfort desiderato.

COVERING Leather, microfiber or fabric. Not removable.

PADDING Ecologic polyurethane foam.

Seat cushion: 30kg/m3 density and backrest cushion 18kg/m3 density covered with a dacron layer 450gr/m2. Armrest cushion: 30kg/m3 density covered with a dacron layer 450gr/m2 with a second dacron insert 200gr/m2. Headrest: double density ecologic polyurethane foam 30 kg/m3 and 18 kg/m3 covered with a dacron layer 450gr/m2.

FEET Chromium-plated steel. Height: 4.5 cm.

FRAME Hard wood combined with plywood and particle board covered with a Dacron layer.

NOTE Adjustable headrest.

REVETEMENT Cuir, microfibre ou tissu non déhoussable.

REMBOURRAGE Coussins d'assise: polyuréthane densité 30 kg/m3 recouverts d'une couche de Dacron de 450 gr/m2. Dossiers: polyuréthane densité 18 kg/m3 recouverts d'une couche de Dacron de 450 gr/m2. Accoudoirs: polyuréthane densité 30 kg/m3 recouverts d'une double couche de Dacron de 450 gr/m2 avec insert en Dacron de 200 gr/m2. Appuis-tête: polyuréthane à densité différenciée de 18 et 30 kg/m3, recouvert d'une couche de Dacron 450 gr/m2. Rembourrage supplémentaire à densité en polyuréthane densité 21 kg/m3.

PIED Acier chromé, h 4,5 cm.

STRUCTURE En bois massif, multiplis et particules habillés d'une couche de dacron.

NOTE Les dossiers sont équipés d'un mécanisme manuel au niveau des appuie-tête, réclinables selon le confort désiré.

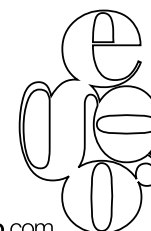
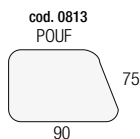
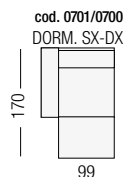
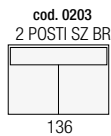
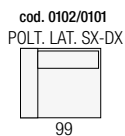
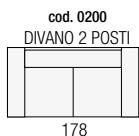
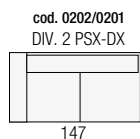
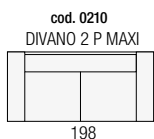
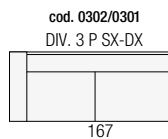
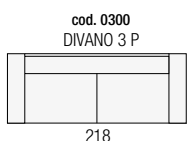
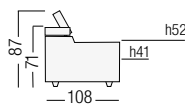
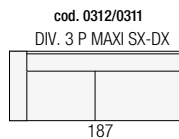
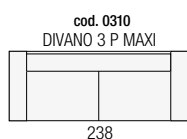

RIVESTIMENTO Pelle o microfibra non sfoderabile, con fiancate applicate realizzate in cuoio, pelle o microfibra. Per le caratteristiche del rivestimento e la manutenzione, vedere relative schede tecniche.

IMBOTTITURA Cuscini di seduta, schienali e braccioli in poliuretano espanso a densità differenziata ricoperti da una falda di dacron da 200 gr/mq. Cuscini di seduta di densità 35 kg/mc per lo strato inferiore e 30 kg/mc per lo strato superiore. Schienale poggiatesta di densità 23 kg/mc ricoperto da una falda di dacron da 450 gr/mq. Schienale testiera di densità 30 kg/mc ricoperto da una falda di dacron da 350 gr/mq. Braccioli di densità 30 kg/mc ricoperti da una falda di dacron da 200 gr/mq.

PIEDI Mod. Flower (disegno esclusivo Egoitaliano), realizzati in alluminio lavorato dal pieno, lucidati e rifiniti a mano.

STRUTTURA Realizzata in legno abbinato a particelle di legno grezzo biodegradabile e pannelli di fibra di legno duro.

NOTE Gli schienali sono dotati di meccanismo a cricchetto reclinabili a seconda del comfort desiderato. Le fiancate applicate sono composte da un telaio metallico imbottito e rivestito a scelta, in cuoio, pelle o microfibra.

COVERING Leather, microfiber or fabric. Not removable.

Sides available in "cuoietto", leather or microfiber.

PADDING Seat cushion and armrest: double density polyurethane foam covered with dacron layer 200gr/m2

SEAT CUSHION bottom part 35kg/m3 upper part: 30kg/m3

Backrest cushion: 23kg/m3 covered with a dacron layer 450gr/m2

Headrest: 30kg/m3 covered with dacron layer 350gr/m2

Armrest: 30kg/m3

FEET Model "Flower", Egoitaliano exclusive design. Hand polished and finished aluminum.

FRAME Hard wood combined with plywood and particle board covered with a Dacron layer.

NOTE Adjustable headrest.

REVÊTEMENT Cuir, microfibre ou tissu non déhoussable.

Avec panneaux latéraux appliqués réalisés en cuir, tissu ou microfibra.

REMBOURRAGE Coussins d'assise, dossiers et accoudoirs en polyuréthane à densité différenciée recouverts d'une couche de dacron 200gr/m2.

Coussins d'assise 35kg/m3 sur la couche inférieure et 30kg sur la supérieure. Dossiers partie cale-reins densité 23kg/m3 recouvert d'une couche de dacron 450gr/m2, partie repose tête densité 30kg/m3 recouverts d'une couche de dacron 350gr/m2.

Accoudoirs: densité 30kg/m3

PIED Modèle Flower (dessin exclusif Egoitaliano), aluminium brillant finition à main.

STRUCTURE En bois massif, multiplis et particules habillés d'une couche de dacron

NOTE Les dossiers sont équipés d'un mécanisme manuel au niveau des appuie-tête, réclinables selon le confort désiré.

Les panneaux latéraux appliqués sont composés d'une structure métallique rembourrée et recouverte au choix en cuir, tissu, microfibra ou « cuoietto »

cod. 0300
DIVANO 3 P

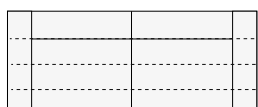

218

cod. 0200
DIVANO 2 POSTI

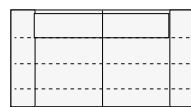

188

cod. 0100
POLTRONA

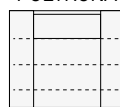

120

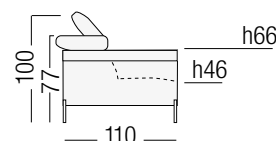

cod. 0302-0301
DIVANO 3 P LAT. SX-DX

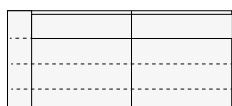

184

cod. 1350/1349
DIV. 3P 3C LAT. SX-DX

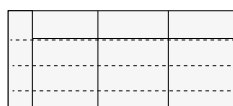

214

cod. 0202-201
DIVANO 2 LAT. SX-DX

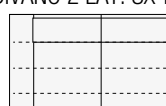

154

cod. 0203
2 POSTI CENTRALE

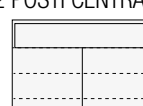

120

cod. 0213
2 P MAXI CENTRALE

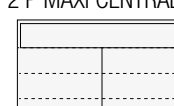

150

cod. 0724/0723
2 P MAXI PENISOLA SX-DX

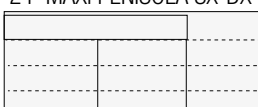

211

cod. 0722/0721
2 P PENISOLA SX-DX

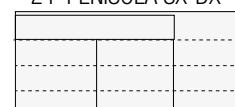

181

cod. 0714/0713
POLTR. MAXI PENIS. SX-DX

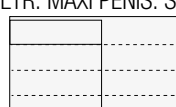

136

cod. 0712/0711
POLTR. PENIS. SX-DX

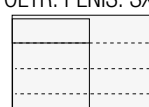

121

cod. 0602
ANGOLO

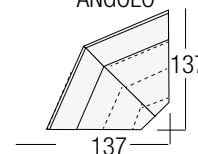

137

cod. 0773/0772
ANG. POL. PENISOLA SX-DX

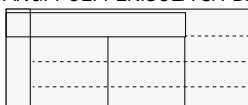

240

cod. 0787/0786
ANG. POL. PENIS. MINI SX-DX

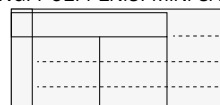

230

cod. 0699-0698
DIV. DORMOSA SX-DX

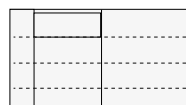

180

cod. 0701-0700
DORMOSA SX-DX

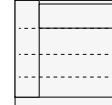

168

94

cod. 0802
POUF

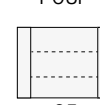

85

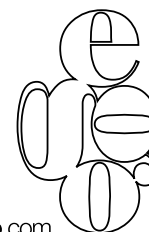

RIVESTIMENTO Pelle o microfibra, non sfoderabile. Per le caratteristiche del rivestimento e la manutenzione, vedere relative schede tecniche.

IMBOTTITURA Cuscino di seduta realizzato in poliuretano espanso di densità 30 kg/mc ricoperto da una falda di dacron da 450 gr/mq. Schienali realizzati in poliuretano espanso di densità 18 kg/mc ricoperti da una falda di dacron da 450 gr/mq. Braccioli realizzati in poliuretano espanso di densità 21 kg/mc ricoperto da falde di dacron da 100 e da 200 gr/mq. Poggiatesta realizzato in poliuretano espanso a densità differenziata da 18 kg/mc e 30 kg/mc, ricoperto da una falda di dacron da 450 gr/mq. Imbottiture di completamento in poliuretano espanso di densità 21 kg/mc.

PIEDI In acciaio cromato.

STRUTTURA Realizzata in legno abbinato a particelle di legno grezzo biodegradabile e pannelli di fibra di legno duro.

NOTE Gli schienali sono dotati di meccanismi manuali con cricchetti a scatti, reclinabili a seconda del comfort desiderato.

COVERING Leather, microfiber or fabric. Not removable.

PADDING Seat cushion 30 kg/m3, backrest cushion 18 kg/m3 and headrest 18-30 kg/m3 covered with dacron layer 450 gr/m2. Armrest 21 kg/m3 covered with dacron layer 100-200 gr/m2

FEET Chromium steel

FRAME Hard wood combined with plywood and particle board covered with a dacron layer.

NOTE Adjustable headrest.

RETEMENT Cuir, microfibre ou tissu non déhoussable.

REMBOURRAGE Coussins d'assise: polyuréthane densité 30 kg/m3 recouverts d'une couche de Dacron de 450 gr/m2. Dossiers: polyuréthane densité 18 kg/m3 recouverts d'une couche de Dacron de 450 gr/m2. Accoudoirs: polyuréthane densité 21 kg/m3 recouverts d'une double couche de Dacron 100 et 200 gr/m2. Appuis-tête: polyuréthane à densité différenciée de 18 et 30 kg/m3, recouvert d'une couche de Dacron 450 gr/m2.

Rembourrage de complément en polyuréthane 21 kg/m3.

PIED Acier chromé.

STRUCTURE En bois massif, multiplis et particules habillés d'une couche de dacron.

NOTE Les dossiers sont équipés d'un mécanisme manuel au niveau des appuie-tête, réclinables selon le confort désiré.

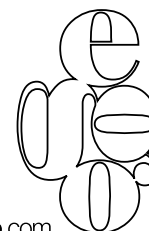
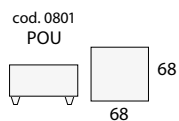
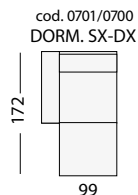
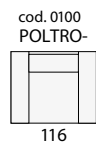
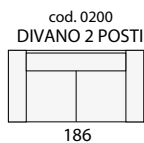
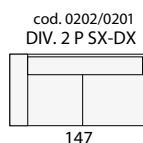
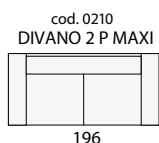
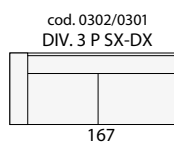
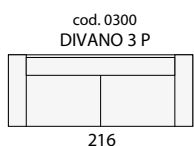
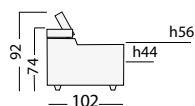
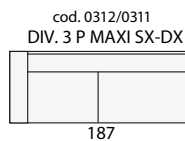
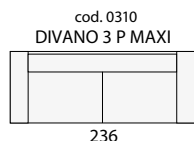

IMBOTTITURA Cuscini di seduta, schienali e braccioli in poliuretano espanso ecologico a densità differenziata ricoperti da una falda di dacron da 450 gr/mq. Cuscini di seduta di densità 35 kg/mc per lo strato inferiore e 30 kg/mc per lo strato superiore. Schienali e braccioli di densità 22 kg/mc.

RIVESTIMENTO Pelle o microfibra non sfoderabile. Per le caratteristiche del rivestimento e la manutenzione vedere relative schede tecniche.

PIEDI In alluminio lucidato o in legno massello di faggio evaporato tinto con vernici ecologiche ad acqua, nei colori: Noce, Noce brunito, Wengè. H 15cm

STRUTTURA Realizzata in legno abbinato a particelle di legno grezzo biodegradabile e pannelli di fibra di legno duro.

NOTE Per ogni seduta, dove predisposto, è possibile richiedere un pratico poggiatesta removibile.

COVERING Leather, microfiber or fabric. Not removable.

PADDING Seat cushion, backrest cushion and armrest: double density polyurethane foam covered with a dacron layer 450gr/m2

Seat cushion: Upper part: 30kg/m3. Lower part: 35kg/m3

Backrest and armrest cushion 22kg/m3

FEET Aluminum or beech feet available with walnut, dark walnut or wengé finishing. Height: 15cm

FRAME Hard wood combined with plywood and particle board covered with a dacron layer.

NOTE Headrest available on demand

REVÊTEMENT Cuir, microfibre ou tissu non déhoussable.

REMBOURRAGE Coussins d'assise, dossiers et accoudoirs en polyuréthane écologique à densité différenciée recouverts d'une couche de Dacron de 450 gr/m2. Coussins d'assise: densité 35 kg/m3 pour la partie inférieure et 30 kg/m3 pour la partie supérieure. Dossiers et accoudoirs: densité 22 kg/m3.

PIED Aluminium brillant ou hêtre massif teinté Noyer, Noyer bruni, Wengé. Hauteur 15cm.

STRUCTURE En bois massif, multiplis et particules habillés d'une couche de dacron.

NOTE Appuie-tête disponible sur demande.

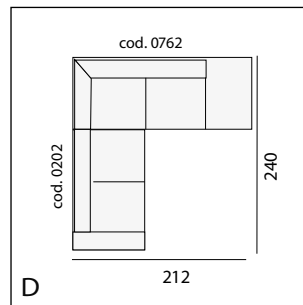
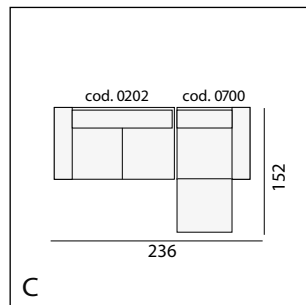
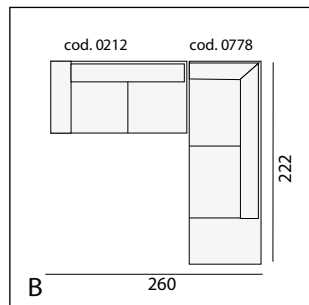
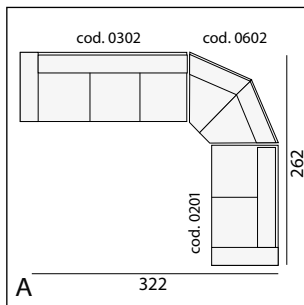
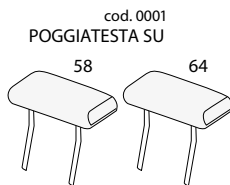
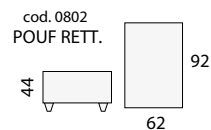
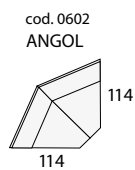
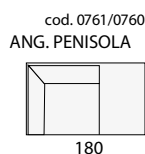
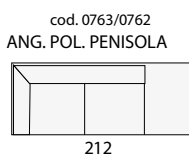
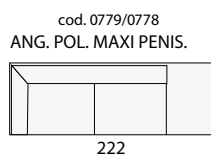
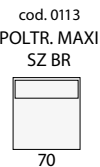
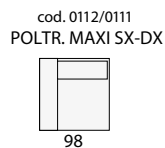
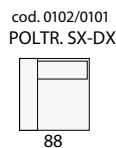
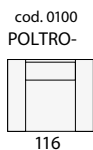
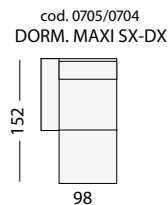
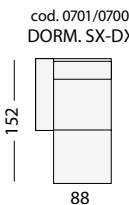
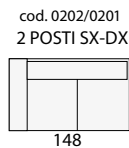
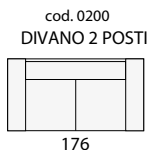
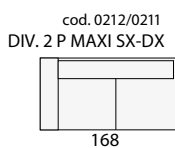
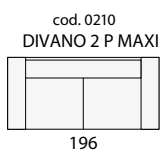
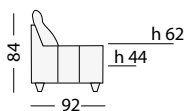
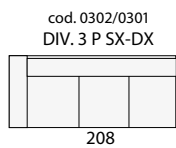
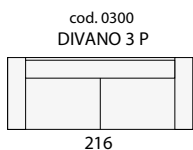

RIVESTIMENTO In pelle e microfibra non sfoderabile. Per le caratteristiche del rivestimento e la manutenzione vedere relative schede tecniche.

IMBOTTITURA Schienali e braccioli realizzati con poliuretano espanso di densità 25 kg/mc ricoperti con falda di dacron resinato autoestinguente. Cuscini di seduta realizzati con poliuretano espanso di densità 35 kg/mc, ricoperti con falda di dacron resinato autoestinguente da 350 gr/mq.

PIEDI In ABS da 5 cm color noce brunito e wengé.

STRUTTURA Realizzata in legno abbinato a particelle di legno grezzo biodegradabile e pannelli di fibra di legno duro.

VERSIONE LETTO Rete 2 pieghe elettrosaldata con aletta poggia guanciaie: divano 3 posti cm 150 x 187 compresa aletta; divano 2 posti maxi cm 120 x 187 compresa aletta. Materasso in poliuretano espanso: divano 3 posti cm 130 x 165 x h 12; divano 2 posti maxi cm 100 x 165 x h 12. Nota: questo meccanismo è dotato di una aletta che consente di avere una profondità complessiva di circa 187 cm.

COVERING Leather, microfiber or fabric. Not removable.

PADDING Backrest and armrest: polyurethane foam 25kg/m3 covered with a dacron layer.

Seat cushion: 35kg/m3 density covered with a dacron layer 350gr/m2.

FEET ABS plastic material. Available finishings: dark walnut or wengé. Height: 5 cm

FRAME Hard wood combined with plywood and particle board covered with a Dacron layer.

Base Electro-welded 2-ply (3 seater 150x187*cm, 2 seater maxi 120x187*cm). *including flap.

MATTRESS Spring, polyurethane on demand (3 seater 130x165x12cm, 2 seater maxi 100x165x12cm)

REVÊTEMENT Cuir, microfibre ou tissu non déhoussable.

REMBOURRAGE Coussins d'assise et accoudoirs en polyuréthane écologique habillé d'un couche de dacron 450 gr/m2.

Coussins d'assise: 30kg/m3. Accoudoirs: 23 kg/m3

PIED En ABS de 5cm teinté noyer bruni ou wengé.

Sommier: Électro-soudé à 2 plis (3 places 150x187*, 2places maxi 120x187*), *ailette comprise.

Matelas: À ressorts, sur demande en polyuréthane (3 places 130x165x12, 2places maxi 100x165x12)

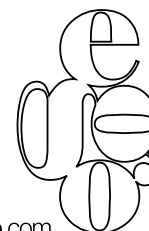
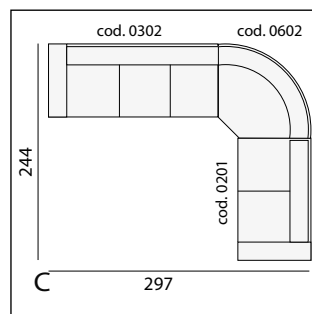
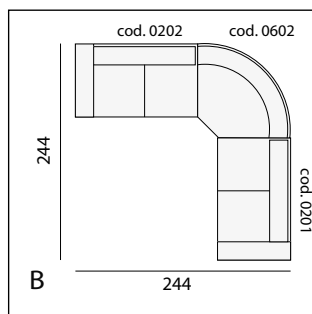
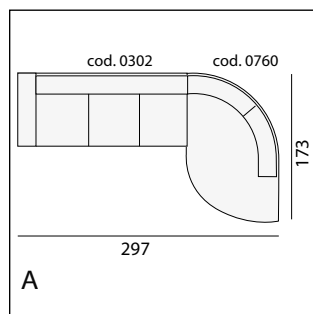
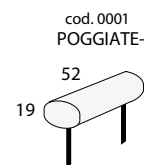
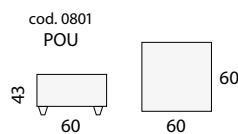
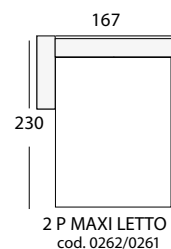
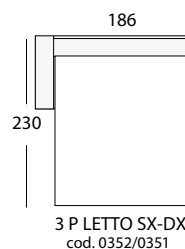
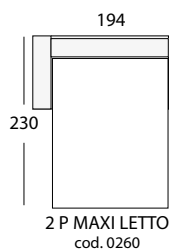
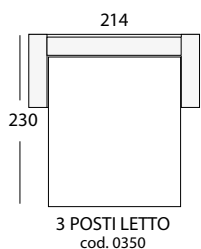
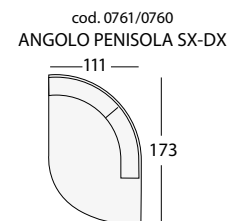
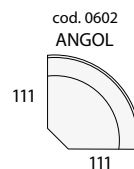
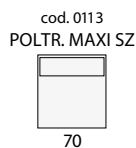
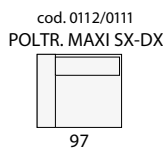
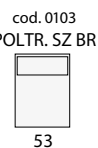
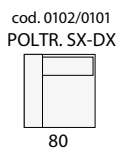
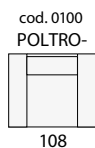
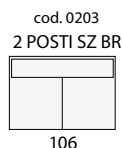
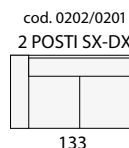
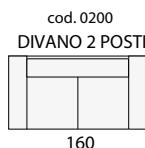
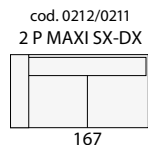
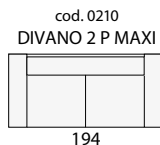
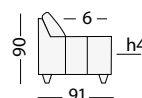
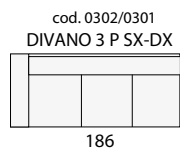
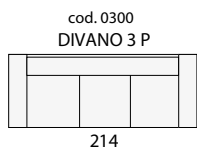

STRUTTURA Realizzata in legno abbinato a particelle di legno grezzo biodegradabile e pannelli di fibra di legno duro.

IMBOTTITURE Cuscino di seduta realizzato in poliuretano espanso di densità 35 kg/mc con sistema integrato di molle elicoidali "pocket spring". Il cuscino di seduta è ricoperto da una falda di dacron da 450 gr/mq. Schienali e braccioli realizzati in poliuretano espanso di densità 22 kg/mc, ricoperti da una falda di dacron da 450 gr/mq.

RIVESTIMENTO Pelle o microfibra, non sfoderabile. Per le caratteristiche del rivestimento e la manutenzione vedere relative schede tecniche.

PIEDI In alluminio lucidato o in legno massello di faggio evaporato, tinto con vernici ecologiche all'acqua, nei colori noce brunito o wengè, h 15 cm.

NOTE per ogni seduta, dove predisposto, è possibile richiedere un pratico poggiatesta removibile.

COVERING Leather, microfiber or fabric. Not removable.

PADDING Seat cushion: polyurethane foam (35kg/m3) combined with "pocket spring" and covered with a dacron layer 450gr/m2.

Backrest cushion and armrest polyurethane foam 22 kg/m3 covered with a dacron layer 450gr/m2.

FEET Aluminum or beech feet available with dark walnut or wengè finishing, h 15 cm.

FRAME Hard wood combined with plywood and particle board covered with a dacron layer.

NOTE Headrest available on demand.

REVETEMENT Cuir, microfibre ou tissu non déhoussable.

REMBOURRAGE Coussins d'assise en polyuréthane écologique 35kg/m3 avec un système de ressorts « pocket spring » recouverts d'une couche de Dacron de 450 gr/m2. Dossiers et accoudoirs en polyuréthane écologique 22 kg/m3 recouverts d'une couche de Dacron de 450 gr/m2.

PIED Aluminium brillant ou hêtre massif teinté noyer bruni or wengè, h 15 cm.

STRUCTURE En bois massif, multiplis et particules habillés d'une couche de dacron.

NOTE Appuie-tête disponible sur demande.

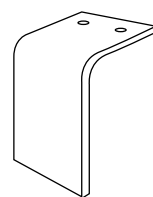
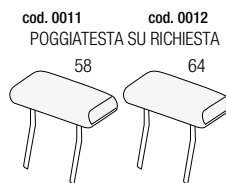
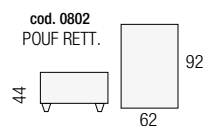
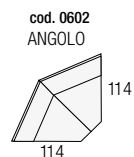
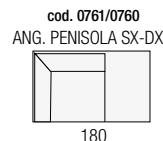
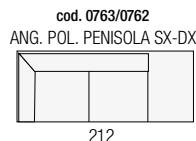
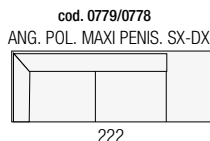
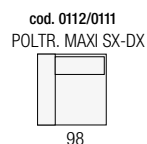
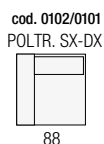
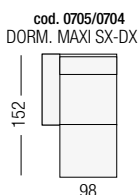
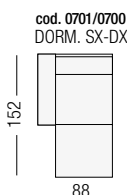
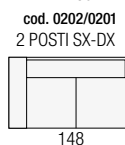
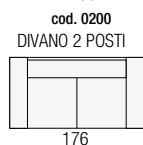
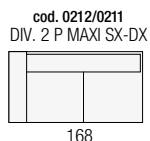
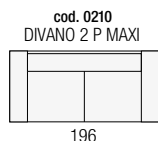
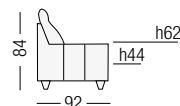
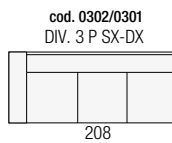
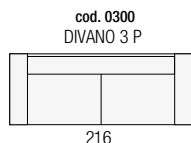

PIEDE IN ALLUMINIO

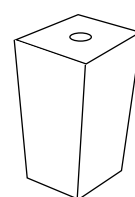

PIEDE IN LEGNO

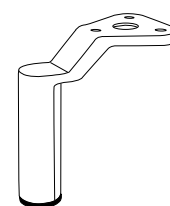

PIEDE VERSIONE SHAKIRA 2

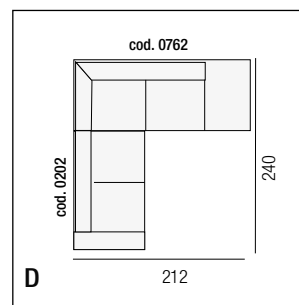
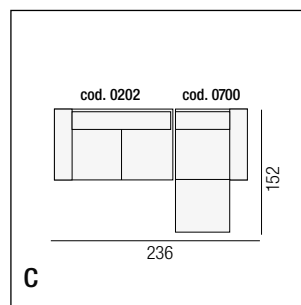
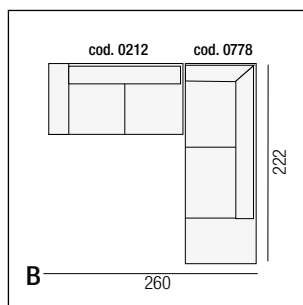
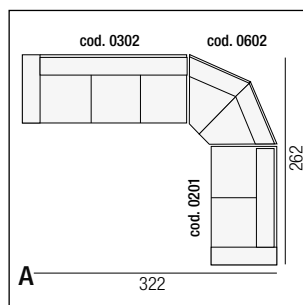

QUESTO DIVANO
MONTA SEDUTA CON
SISTEMA INTEGRATO
DI MOLLE ELICOIDALI
POCKET SPRING.

POCKET SPRING SEAT.
ASSISE AVEC RESSORT.

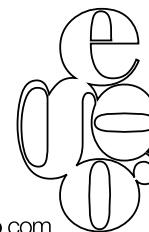

RIVESTIMENTO In pelle e microfibra non sfoderabile. Per le caratteristiche del rivestimento e la manutenzione vedere relative schede tecniche.

IMBOTTITURE Schienali e braccioli realizzati con poliuretano espanso di densità 25 kg/mc ricoperti con falda di dacron resinato autoestinguente.

Cuscini di seduta realizzati in poliuretano espanso di densità 35 kg/mc, ricoperti con falda di dacron resinato autoestinguente da 350 gr/mq.

PIEDINI In legno da cm 5 color noce brunito e wengè.

STRUTTURA Realizzata in legno abbinato a particelle di legno grezzo biodegradabile e pannelli di fibra di legno duro.

VERSIONE LETTO Rete 2 pieghe elettrosaldata con aletta poggia guanciaie.

Divano 3 posti cm 150 x 187 compresa aletta; divano 3 posti mini cm 140 x 187 compresa aletta. **Materasso** in poliuretano espanso: Divano 3 posti cm 130 x 165 x h 12; divano 3 posti mini cm 120 x 165 x h 12. Nota: questo meccanismo è dotato di una aletta che consente di avere una profondità complessiva di circa 187 cm.

VERSIONE RLX Realizzato con meccanismo combinato con movimento schienale e poggiatesta. Disponibile sia manuale che elettrico con comando posizionato sul bracciolo laterale. L'elemento RLX è sempre staccato dall'elemento fisso e viene

COVERING Leather, microfiber or fabric. Not removable.

PADDING Armrest and backrest cushion 25kg/m3 polyurethane foam covered with a dacron layer.

Seat cushion 35kg/m3 polyurethane foam covered with a dacron layer 350gr/m2.

FEET Wood 5cm - Finishing available dark walnut and wenge

FRAME Hard wood combined with plywood and particle board covered with a dacron layer.

Bed base Electro-welded 2-ply equipped with an extension for a total depth of 187cm. **Bed base** 3 seater 150x187*cm - bed base mini 3 seater 140x187*cm *including extension.

Mattress Spring or polyurethane foam mattress on demand (3 seater 130x165x12cm - mini 3 seater 120x165x12cm)

NOTE Manual or electric recliner available.

REVÈTEMENT Cuir, microfibre ou tissu non déhoussable.

REMBOURRAGE Dossier et accoudoir en polyuréthane écologique densité 25 kg/mc habillé d'un couche de dacron. Assise en polyuréthane écologique densité 35 kg/mc habillé d'un couche de dacron densité 350 gr/m2.

PIEDS En bois de 5 cm, couleurs disponibles noyer bruni ou wengé.

STRUCTURE En bois massif, multiplis et particules habillés d'un couche de dacron.

Sommier Électro-soudé à 2 plis équipé avec un extension pour un profondeur total de 187cm. **Sommier** 3 places 150x187* - Sommier 3places mini 140x187* *extension inclus

MATELAS À ressorts, sur demande en polyuréthane

Matelas 3 places: 130x165x12 - Matelas 3 places mini: 120x165x12

NOTE Mécanisme relax manuel ou électrique disponible.

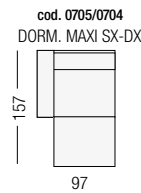
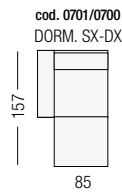
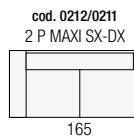
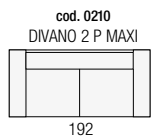
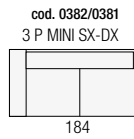
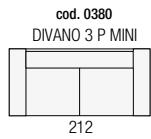
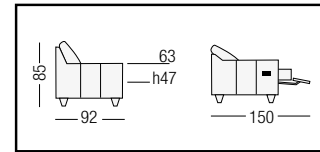
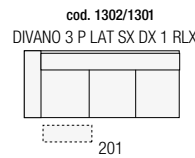
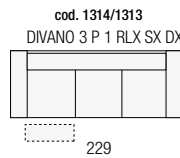
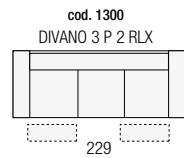
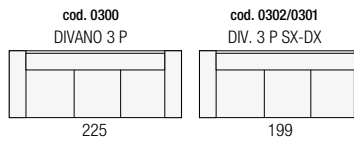

RAMONA

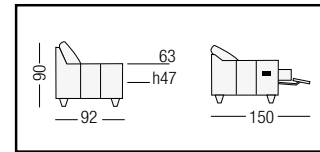

RAMONA 2

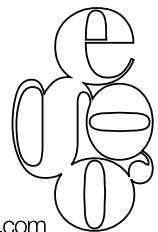
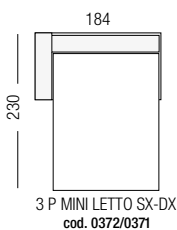
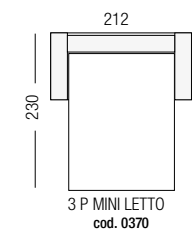
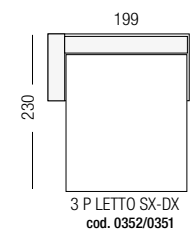
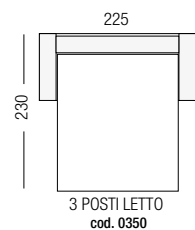
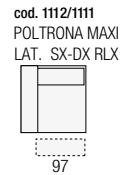
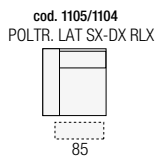
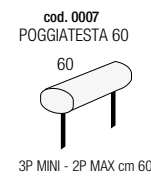
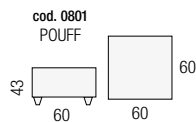
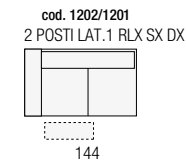
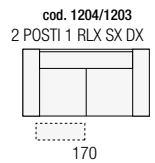
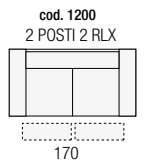
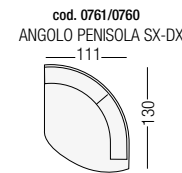
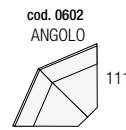
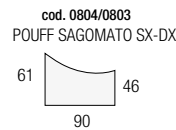
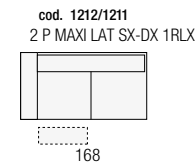
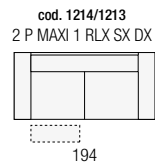
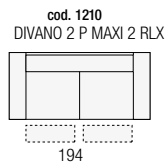
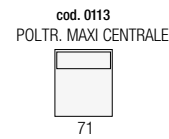
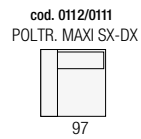
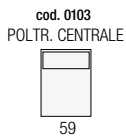
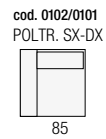
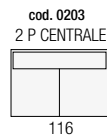
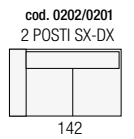
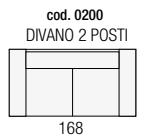

RIVESTIMENTO In pelle e microfibra non sfoderabile. Per le caratteristiche del rivestimento e la manutenzione vedere relative schede tecniche.

IMBOTTITURE Schienali e braccioli realizzati con poliuretano espanso di densità 25 kg/mc ricoperti con falda di dacron resinato autoestinguente. Cuscini di seduta realizzati in poliuretano espanso di densità 35 kg/mc, ricoperti con falda di dacron resinato autoestinguente da 350 gr/mq.

PIEDINI In legno da cm 5 color noce brunito e wenge.

STRUTTURA Realizzata in legno abbinato a particelle di legno grezzo biodegradabile e pannelli di fibra di legno duro.

VERSIONE LETTO Rete 2 pieghe elettrosaldata con aletta poggia guanciaie. Divano 3 posti cm 150 x 187 compresa aletta; divano 3 posti mini cm 140 x 187 compresa aletta. **Materasso** in poliuretano espanso: Divano 3 posti cm 130 x 165 x h 12; divano 3 posti mini cm 120 x 165 x h 12. Nota: questo meccanismo è dotato di una aletta che consente di avere una profondità complessiva di circa 187 cm.

VERSIONE RLX Realizzato con meccanismo combinato con movimento schienale e poggiatesta. Disponibile sia manuale che elettrico con comando posizionato sul bracciolo laterale. L'elemento RLX è sempre staccato dall'elemento fisso e viene

COVERING Leather, microfiber or fabric. Not removable.

PADDING Armrest and backrest cushion 25kg/m3 polyurethane foam covered with a dacron layer.

Seat cushion 35kg/m3 polyurethane foam covered with a dacron layer 350gr/m2.

FEET Wood 5cm - Finishing available dark walnut and wenge

FRAME Hard wood combined with plywood and particle board covered with a dacron layer.

Bed base Electro-welded 2-ply equipped with an extension for a total depth of 187cm. **Bed base** 3 seater 150x187*cm – bed base mini 3 seater 140x187*cm *including extension.

Mattress Spring or polyurethane foam mattress on demand (3 seater 130x165x12cm - mini 3 seater 120x165x12cm)

NOTE Manual or electric recliner available.

REVÊTEMENT Cuir, microfibre ou tissu non déhoussable.

REMBOURRAGE Dossier et accoudoir en polyuréthane écologique densité 25 kg/mc habillé d'un couche de dacron. Assise en polyuréthane écologique densité 35 kg/mc habillé d'un couche de dacron densité 350 gr/m2.

PIEDS En bois de 5 cm, couleurs disponibles noyer bruni ou wengé.

STRUCTURE En bois massif, multiplis et particules habillés d'un couche de dacron.

Sommier Électro-soudé à 2 plis équipé avec un extension pour un profondeur total de 187cm. **Sommier** 3 places 150x187* - Sommier 3places mini 140x187* *extension inclus

MATELAS À ressorts, sur demande en polyuréthane

Matelas 3 places: 130x165x12 - Matelas 3 places mini: 120x165x12

NOTE Mécanisme relax manuel ou électrique disponible.

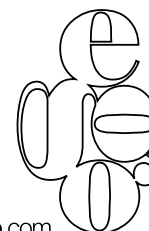
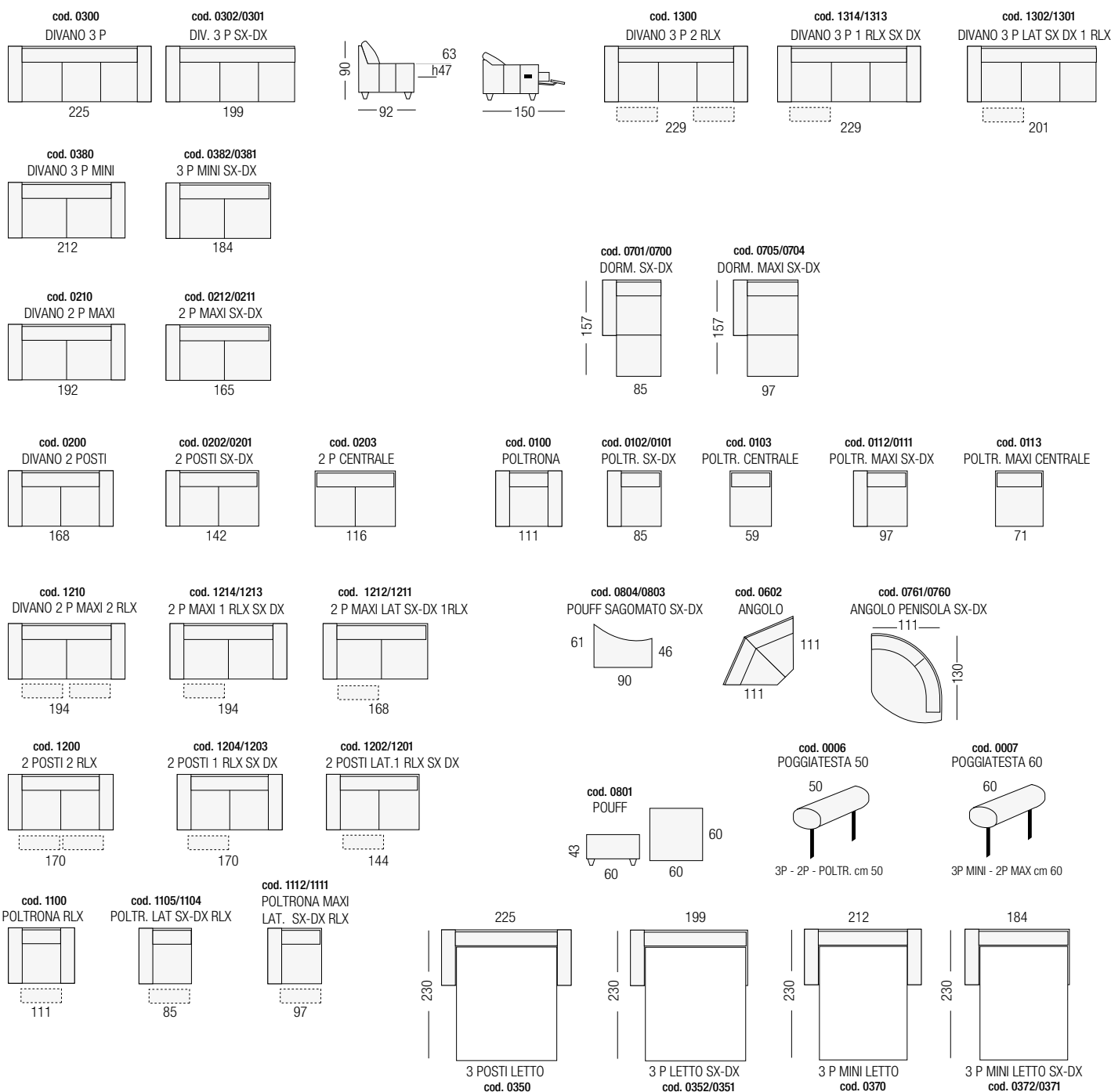

MARYLIN E FLOWER

STRUTTURA Particelle di legno grezzo biodegradabile e pannelli di fibra di legno duro.
IMBOTTITURE Cuscino di seduta realizzato in poliuretano espanso di densità 35 kg/mc.
RIVESTIMENTO In pelle, ecopelle lucida con possibilità di stampa serigrafica, tessuto e microfibra non sfoderabile. Per le caratteristiche del rivestimento e la manutenzione vedere relative schede tecniche.
PIEDINI In ABS.

COVERING Leather, microfiber, fabric or shining polyurethane covering available with serigraphy. Not removable.
PADDING Seat cushion: 35kg/m3 polyurethane foam
FEET Plastic material
FRAME Hard wood combined with plywood and particle board covered with a dacron layer.

REVÊTEMENT Cuir, microfibre, tissu ou revêtement en polyuréthane disponible avec sérigraphie. Non déhoussable.
REMBOURRAGE Coussins d'assise en polyuréthane écologique densité 35kg/m3
PIEDS en matériel plastique
STRUCTURE Bois recouvert d'une couche de dacron

cod.0801

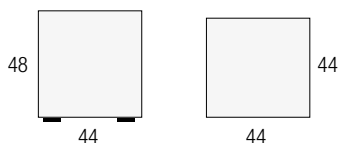

Rev. 10/2011

GRACE & CLIO

STRUTTURA Realizzata in legno abbinato a particelle di legno grezzo biodegradabile e pannelli di fibra di legno duro.
IMBOTTITURE Cuscino di seduta realizzato con poliuretano espanso di densità 30 kg/mc, ricoperti con falda di dacron resinato autoestinguente da 350 gr/mq.
RIVESTIMENTO In pelle e microfibra non sfoderabile. Per le caratteristiche del rivestimento e la manutenzione vedere relative schede tecniche.
PIEDI In ABS.
NOTE Il pouff è dotato di contenitore con meccanismo alza cuscino.

COVERING Leather, microfiber or fabric. Not removable.
PADDING Seat cushion 30kg/m3 polyurethane foam covered with a dacron layer 350gr/m2
FEET Plastic material
FRAME Hard wood combined with plywood and particle board covered with a dacron layer.
NOTE storage stool equipped with manual opening system

REVÊTEMENT Cuir, microfibre ou tissu non déhoussable.
REMBOURRAGE Coussins d'assise en polyuréthane écologique densité 30kg/m3 habillé d'un couche de dacron 350 gr/m2.
PIEDS en matériel plastique.
STRUCTURE Bois recouvert d'une couche de dacron
NOTE pouf coffre équipé avec mécanisme d'ouverture manuel.

GRACE cod.0805

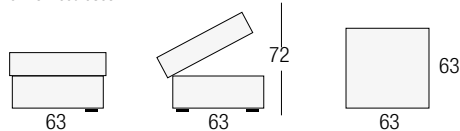

CLIO cod.0805

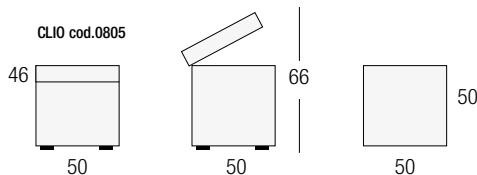

Rev. 10/2011

RONDÒ

STRUTTURA Realizzata in legno abbinato a particelle di legno grezzo biodegradabile e pannelli di fibra di legno duro.
IMBOTTITURA Seduta in poliuretano espanso di densità 30 kg/mc ricoperto da una falda di dacron da 200 gr/mq
RIVESTIMENTO Pelle, tessuto o microfibra non sfoderabile. Per le caratteristiche del rivestimento e la manutenzione, vedere relative schede tecniche.
PIEDI In ABS da cm 2.
NOTE Seduta trapuntata. Disponibile nella misura 103 cm (rondò) e 88cm (rondò mini).

COVERING Leather, microfiber or fabric. Not removable.
PADDING Seat cushion 30kg/m3 polyurethane foam covered with a dacron layer 200gr/m2
FEET Plastic material, h 2 cm.
FRAME Hard wood combined with plywood and particle board covered with a dacron layer.
NOTE Quilted seat. Available in sizes 103 cm (rondò) and 88cm (mini roundabout).

REVÊTEMENT Cuir, microfibre ou tissu non déhoussable.
REMBOURRAGE Coussins d'assise en polyuréthane écologique densité 30kg/m3 habillé d'un couche de dacron 200 gr/m2.
PIEDS en matériel plastique. Hauteur 2cm.
STRUCTURE Bois recouvert d'une couche de dacron
NOTE assise matelassé. Disponible en deux dimensions - Rondò: diamètre 103cm et Rondò mini: diamètre 88 cm

RONDO cod. 0800

RONDO MINI cod. 0800

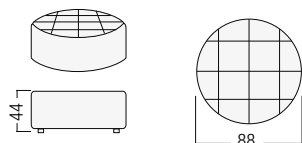
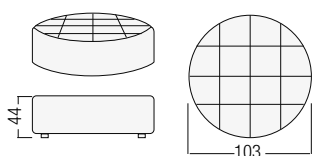

Rev. 10/2011

ERIKA

RIVESTIMENTO In pelle, tessuto o microfibra. Per le caratteristiche del rivestimento e della manutenzione, vedere relative schede tecniche.
IMBOTTITURA Realizzata con polistirolo in palline racchiuso in un involucro

COVERING Leather, microfiber or fabric. Not removable.
PADDING Shaped cotton covering filled with polystyrene little balls.

REVÊTEMENT Cuir, microfibre ou tissu non déhoussable.
REMBOURRAGE Billes de polystyrène dans une toile de coton modelée

cod. 0801

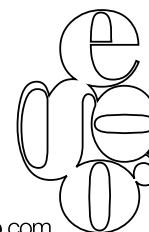
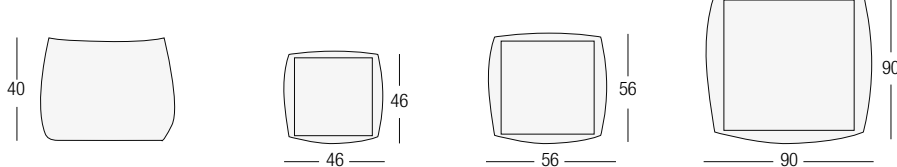

RIVESTIMENTO Pelle o microfibra non sfoderabile. Per le caratteristiche del rivestimento e la manutenzione vedere relative schede tecniche.

IMBOTTITURA Cuscini schienali realizzati in poliuretano espanso a doppia densità; parte superiore (schienale) di densità 28 Kg/mc, parte inferiore (poggiareni) di densità 23 Kg/mc. Cuscini di seduta realizzati in poliuretano espanso di densità 35 kg/mc con uno strato superiore di densità 30 Kg/mc. Schienali, poggiatesta e cuscini di seduta sono ricoperti con termofalda di dacron resinato autoestinguente da 450 gr/mq.

PIEDI In alluminio pressofuso e lucidato da cm 14.

STRUTTURA Realizzata in legno abbinato a particelle di legno grezzo biodegradabile e pannelli di fibra di legno duro.

NOTE Il modello è dotato di meccanismi a cricchetto che permettono di variare la posizione dell'estremità dei divani, assecondando così svariate esigenze di comfort. Tali meccanismi non sono presenti nelle versioni con penisola. Su richiesta è possibile dotare i divani di pratici poggiatesta.

COVERING Leather, microfiber or fabric. Not removable.

PADDING Backrest: double density ecologic polyurethane foam. Bottom part 23 kg/m3 density and upper part 28 kg/m3 density. Seat cushion: double density ecologic polyurethane foam. Bottom part 35 kg/m3 density and upper part 30 kg/m3 density. Seat and back cushion covered with 450 gr/m2 dacron layer.

FEET Polished aluminium.

FRAME Hard wood combined with plywood and particle board covered with a dacron layer.

NOTE Adjustable armrest not available on "lhf/rhf va one seater chaise" (code 0763/0762). All other versions are always equipped with adjustable armrests.

REVETEMENT Cuir, microfibre ou tissu. Les revêtements sont fixes.

REMBOURRAGE Dossier en polyuréthane écologique avec double densité. Partie supérieure 28kg/m3. Partie inférieure 23kg/m3. Assise en polyuréthane écologique avec double densité. Partie supérieure 30kg/m3. Partie inférieure 35kg/m3. Assise et dossier habillé d'une couche de dacron avec densité 450 gr/m2.

PIED Aluminium brillant.

STRUCTURE En bois massif, multiplis et particules habillés d'une couche de dacron.

NOTE Version angle méridienne (code 0763/0762) pas disponible avec mécanisme sur les accoudoirs.

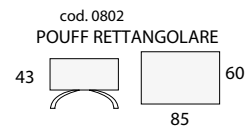
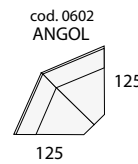
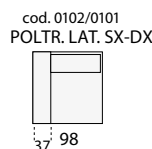
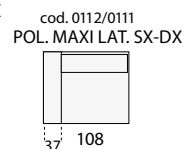
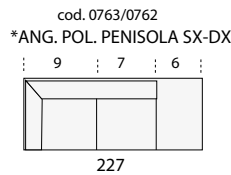
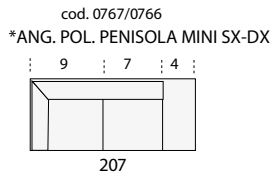
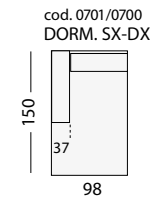
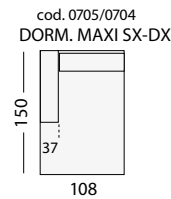
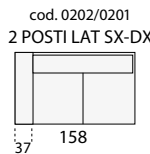
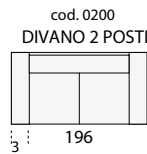
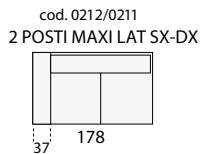
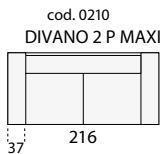
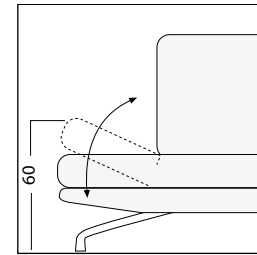
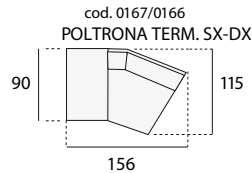
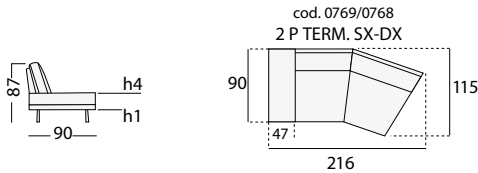

* LE VERSIONI CON ANGOLO POL. PENISOLA NON SONO DOTATE DI MECCANISMO NELLA PARTE TERMINALE

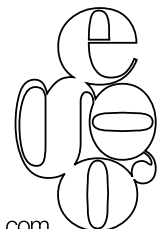
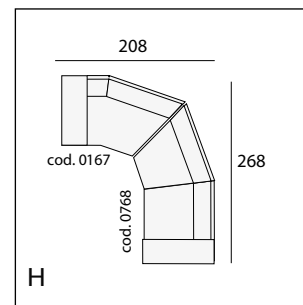
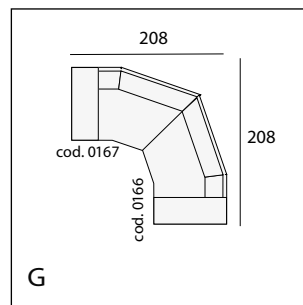
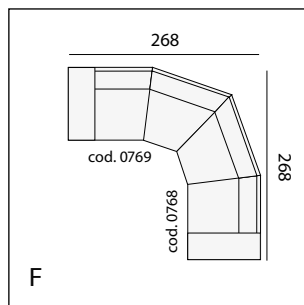
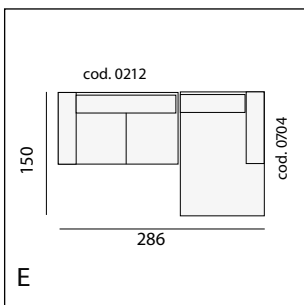
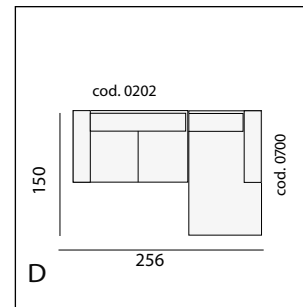
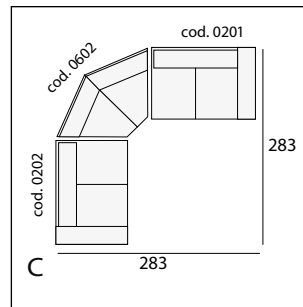
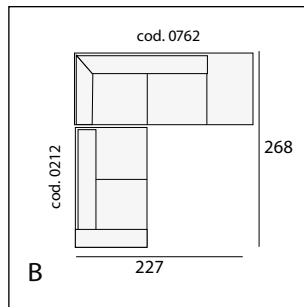
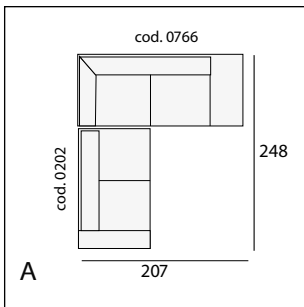

STRUTTURA Realizzata in legno abbinato a particelle di legno grezzo biodegradabile e pannelli di fibra di legno duro.

IMBOTTITURE In poliuretano espanso ecologico a densità differenziate.

Cuscino di seduta versione fissa di densità 28 kg/mc, versione letto 30 kg/mc. Cuscini schienali di densità 30 kg/mc. Braccioli di densità 40 kg/mc. Il cuscino di seduta è ricoperto da una termofalda di dacron autoestinguente da 350 gr/mq. La struttura ed i cuscini schienali sono rivestiti da una falda di tomana (ovatta resinata accoppiata con tessuto non tessuto).

VERSIONE LETTO Le versioni letto sono dotate di reti a 2 pieghe elettrosaldate, realizzate in acciaio ad alta resistenza, verniciate a forno con polveri epossidiche.

Reti divano 3 posti: 180 x 201; divano 2 posti maxi: 160 x 201;

2 posti: 140 x 201; poltrona: 90 X 201;

Materassi in poliuretano espanso 3 posti: 160 x 193 x 13; 2 posti maxi: 140 x 193 x 13; 2 posti: 120 x 193 x 13; poltrona: 70 X 193 X 13;

RIVESTIMENTO Pelle non sfoderabile, tessuto e microfibra sfoderabile. Per le caratteristiche del rivestimento e la manutenzione vedere relative schede tecniche. Solo sulla versione Cecilia il bracciolo non è sfoderabile.

PIEDINI In legno massello di faggio evaporato, tinto con vernici ecologiche all'acqua, nei colori noce, noce brunito o wengé. h cm 5.

Per il mod. Cecilia piede in acciaio cromato.

FRAME Hard wood combined with plywood and particle board covered with a dacron layer.

PADDING Seat cushion, backrest cushion and armrest: double density polyurethane foam covered with dacron layer 450gr/m2

Seat cushion 28 kg/m3 fix version – 30 kg/m3 sofabed version

Backrest cushion 30kg/m3

Armrest cushion 40kg/m3

Seat cushion covered with dacron layer 350gr/m2

Frame and backrest cushions covered a layer of cotton wood coupled with "non-woven" fabric

SOFABED Electro-welded orthopaedic bed base with elastic belts support in the seating area. Mechanism equipped with pillows storage space

Bed Base 3 seater: 180 x 201; 2 seater maxi: 160 x 201;

2 seater: 140 x 201; armchair: 90 X 20

Mattress 3 seater: 160 x 193 x 13; 2 seater maxi: 140 x 193 x 13;

2 seater: 120 x 193 x 13; armchair: 70 X 193 X 13;

COVERING Leather (not removable), fabric or microfiber, (removable).

FEET Wood 5cm - Colours available: walnut, dark walnut, wengé.

For the mod. Cecilia chrome-plated steel feet.

CARCASSE En bois massif, multiplis et particules habillés d'un couche de dacron.

REMBOURRAGE en polyuréthane écologique a densité différenciée. Assise version fixe densité 28 kg/mc (version avec lit 30 kg/mc) habillé d'un couche de dacron (densité 350 gr/m2). Dossier: densité 30 kg/mc. Accoudoir: 40 kg/mc. Coussin de dossier et accoudoir habillé par une couche de dacron accouplé avec tissu "non-woven"

CANAPÉ-LIT Convertible à mailles électrosoudées, Espace de rangement ses oreillers. Assises sur sangles élastiques croisées.

Sommier 3 places 180 x 201; 2 places maxi: 160 x 201;

2 places 140 x 201; fauteuil: 90 X 201;

Couchage 3 places: 160 x 193 x 13; 2 places maxi: 140 x 193 x 13;

2 places: 120 x 193 x 13; fauteuil: 70 X 193 X 13;

REVÊTEMENT: Cuir (revêtement fixe). Microfibre ou tissu (revêtement déhoussable)

PIED: En bois teinté wengé, noyer et noyer bruni. Hauteur 5 cm.

Pour le mod. Cecilia pied en acier chromé.

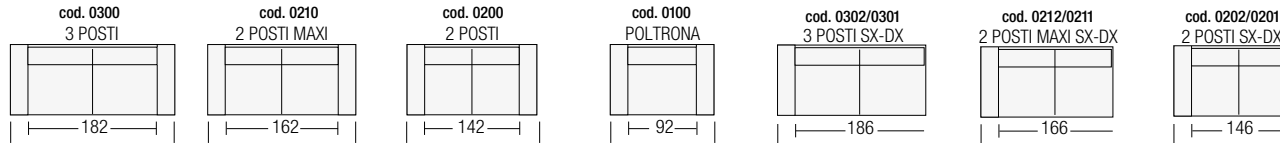

	SILVIA	236	216	196	146	213	193	173
	NIVES - CECILIA	234	214	194	144	212	192	172
	GIULIA - EMILIA	226	206	186	136	208	188	168
	GIULIA MINI	214	194	174	124	202	182	162
	GIULIETTA	206	186	166	116	198	178	160
	VALENTINA	192	172	152	102	191	171	151

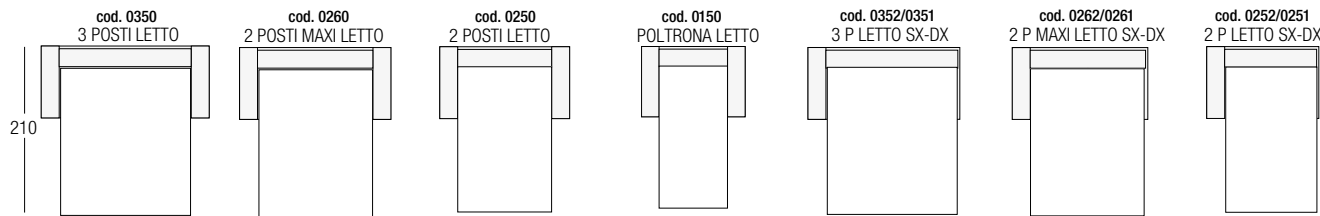

	SILVIA	236	216	196	146	213	193	173
	NIVES - CECILIA	234	214	194	144	212	192	172
	GIULIA - EMILIA	226	206	186	136	208	188	168
	GIULIA MINI	214	194	174	124	202	182	162
	GIULIETTA	206	186	166	116	198	178	160
	VALENTINA	192	172	152	102	191	171	151

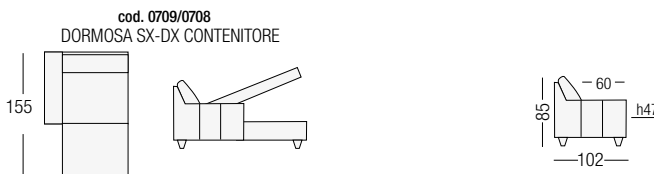

	SILVIA	115
	NIVES - CECILIA	114
	GIULIA - EMILIA	110
	GIULIA MINI	104
	GIULIETTA	100
	VALENTINA	93

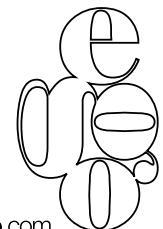

RIVESTIMENTO In tessuto e microfibra completamente sfoderabile, in pelle non sfoderabile con cuscini di seduta removibili. Per le caratteristiche del rivestimento e la manutenzione vedere relative schede tecniche.

IMBOTTITURA Schienali realizzati con poliuretano espanso di densità 23 kg/mc ricoperti di dacron resinato autoestinguente. Cuscini di seduta realizzati con poliuretano espanso di densità 30 kg/mc, ricoperti con falda di dacron resinato autoestinguente da 350 gr/mq.

PIEDI In ABS da cm 5.

STRUTTURA Realizzata in legno abbinato a particelle di legno grezzo biodegradabile e pannelli di fibra di legno duro.

NOTE Il modello è caratterizzato dalla componibilità dei tre elementi senza alcun vincolo essendo completamente rivestiti e quindi intercambiabili.

COVERING Fabric or microfiber, (removable). Leather not removable with detachable seat cushions.

PADDING Backrest cushion: ecologic polyurethane foam 23 kg/mc covered with a dacron layer. Seat cushion ecologic polyurethane foam 30 kg/mc covered with a dacron layer 350gr/m2.

FEET ABS plastic. Height: 5 cm

FRAME Hard wood combined with plywood and particle board covered with a dacron layer.

REVÊTEMENT Microfibre ou tissu (revêtement déhoussable) Cuir : revêtement fixe avec assises dehoussables

REMBOURRAGE Dossier en polyuréthane écologique densité 23 kg/mc habillé d'un couche de dacron. Assise en polyuréthane écologique densité 30 kg/mc habillé d'un couche de dacron densité 350 gr/m2.

PIED En matériel plastic (ABS) Hauteur 5cm.

STRUCTURE En bois massif, multiplis et particules habillés d'une couche de dacron.

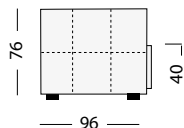

cod. 0600
ANGOLO

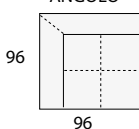

cod. 0103
POLTRONA SZ BR

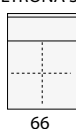

cod. 0802
POUF RETT.

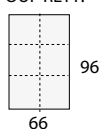

cod. 9991
GUANCIALE

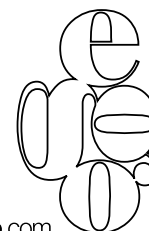
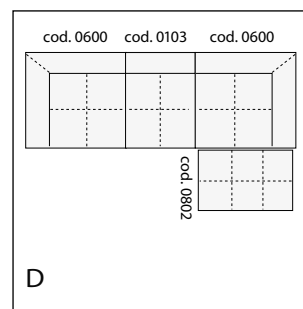
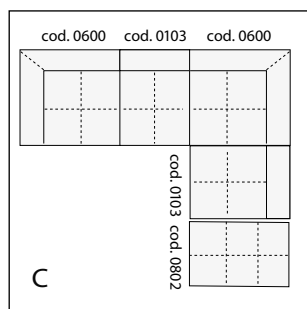
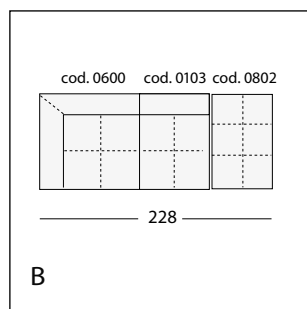
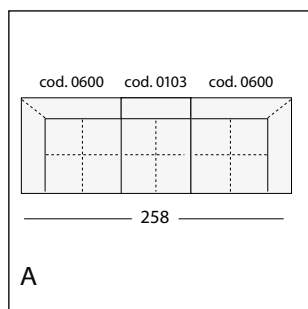
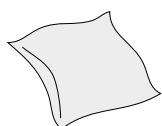

RIVESTIMENTO In tessuto, microfibra completamente sfoderabile. In pelle non sfoderabile. Per le caratteristiche del rivestimento e la manutenzione vedere relative schede tecniche.

IMBOTTITURA Schienali realizzati con poliuretano espanso di densità 23 kg/mc ricoperti di dacron resinato autoestinguento. Cuscini di seduta realizzati con poliuretano espanso di densità 35 kg/mc, ricoperti con falda di dacron resinato autoestinguento da 350 gr/mq.

PIEDI In metallo, legno noce brunito e wengè. H 13,5 cm

STRUTTURA Realizzata in legno abbinato a particelle di legno grezzo biodegradabile e pannelli di fibra di legno duro.

COVERING Leather (not removable), fabric or microfiber, (removable).

PADDING Backrest cushion: ecologic polyurethane foam 23 kg/mc covered with a dacron layer. Seat cushion ecologic polyurethane foam 35 kg/mc covered with a dacron layer 450gr/m2.

FEET Metal base or wood feet available with dark walnut or wengé finishing. Height: 13.5 cm

FRAME Hard wood combined with plywood and particle board covered with a dacron layer.

REVÊTEMENT Cuir (revêtement fixe). Microfibre ou tissu (revêtement déhoussable)

REMBOURRAGE Dossier en polyuréthane écologique densité 23 kg/mc habillé d'un couche de dacron. Assise en polyuréthane écologique densité 35 kg/mc habillé d'un couche de dacron densité 350 gr/m2.

PIED Base en métal ou pied en bois couleurs disponibles noyer bruni ou wengé, H 13,5 cm

STRUCTURE En bois massif, multiplis et particules habillés d'une couche de dacron.

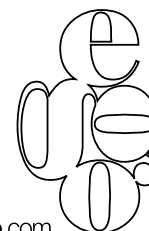
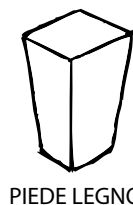
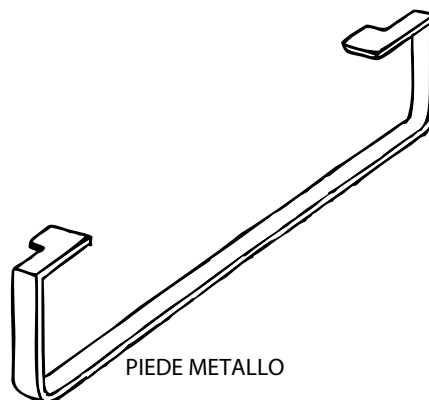
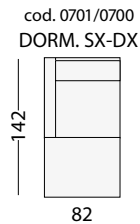
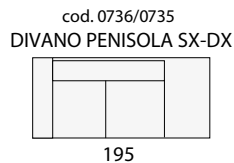
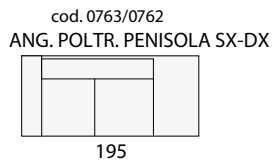
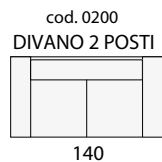
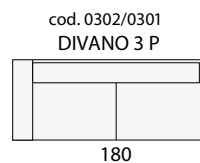
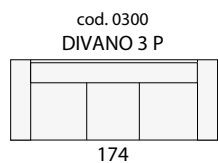
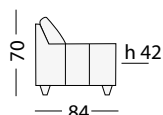
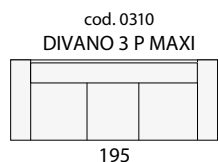

RIVESTIMENTO In pelle e microfibra non sfoderabile. Per le caratteristiche del rivestimento e la manutenzione vedere relative schede tecniche.

IMBOTTITURA Schienali e braccioli realizzati con poliuretano espanso di densità 25 kg/mc ricoperti con falda di dacron resinato autoestinguente.

Cuscini di seduta realizzati con poliuretano espanso di densità 35 kg/mc, ricoperti con falda di dacron resinato autoestinguente da 350 gr/mq.

PIEDI In legno altezza 5 cm. colori disponibili wenge, noce brunito

VERSIONE LETTO: Rete 2 pieghe elettrosaldata con aletta poggia guanciaie: divano 3 posti cm 150 x 187 compresa aletta; divano 3 posti mini cm 140 x 187 compresa aletta. Materasso in poliuretano espanso: divano 3 posti cm. 130 x 165 x h 12; divano 3 posti mini cm. 120 x 165 x h 12. Nota: questo meccanismo è dotato di una aletta che consente di avere una profondità complessiva di circa 187 cm.

VERSIONE RELAX: Realizzato con meccanismo combinato con movimento schienale e poggiatesta. Disponibile sia manuale che elettrico con comando posizionato sul bracciolo laterale. L'elemento RLX è sempre staccato dall'elemento fisso e viene agganciato con apposito sistema a baionetta.

STRUTTURA Realizzata in legno abbinato a particelle di legno grezzo biodegradabile e pannelli di fibra di legno duro.

NOTE L'elemento terminale tondo è caratterizzato dallo schienale trapuntato. Su richiesta è possibile avere lo schienale senza trapunta.

COVERING Leather, microfiber or fabric. Not removable.

PADDING Ecologic polyurethane foam. Seat cushion 35 kg/m3. Armrest and backrest cushion 25kg/m3. Seat cushion covered with dacron layer 350gr/m2.

FEET Wood 5cm - color available dark walnut and wenge.

BED BASE Electro-welded 2-ply equipped with an extension for a total depth of 187cm. Bed base 3 seater 150x187*cm – bed base mini 3 seater 140x187*cm. *including flap.

MATTRESS Spring or polyurethane foam mattress on demand (3 seater 130x165x12cm - mini 3 seater 120x165x12cm).

FRAME Hard wood combined with plywood and particle board covered with a dacron layer.

NOTE. End round chaise equipped with quilted backrest cushion. Standard plain backrest cushion available on demand.

Manual or electric recliner available.

REVEITEMENT Cuir, microfibre ou tissu non déhoussable.

REMBOURRAGE Dossier et accoudoir en polyuréthane écologique densité 25 kg/mc habillé d'un couche de dacron. Assise en polyuréthane écologique densité 35 kg/mc habillé d'un couche de dacron densité 350 gr/m2.

PIED En bois de 5cm teinté noyer bruni ou wengé.

SOMMIER Electro-soudé à 2 plis équipé avec un extension pour un profondeur total de 187cm. Sommier 3 places 150x187* - Sommier 3places mini 140x187*. *extension inclus.

MATELAS À ressorts, sur demande en polyuréthane Matelas 3 places: 130x165x12 - Matelas 3 places mini: 120x165x12

STRUCTURE En bois massif, multiplis et particules habillés d'un couche de dacron.

NOTE Terminal rond avec dossier matelassé. Disponible sur demande avec dossier lisse.

Mécanisme relax manuel ou électrique disponible.

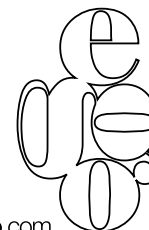
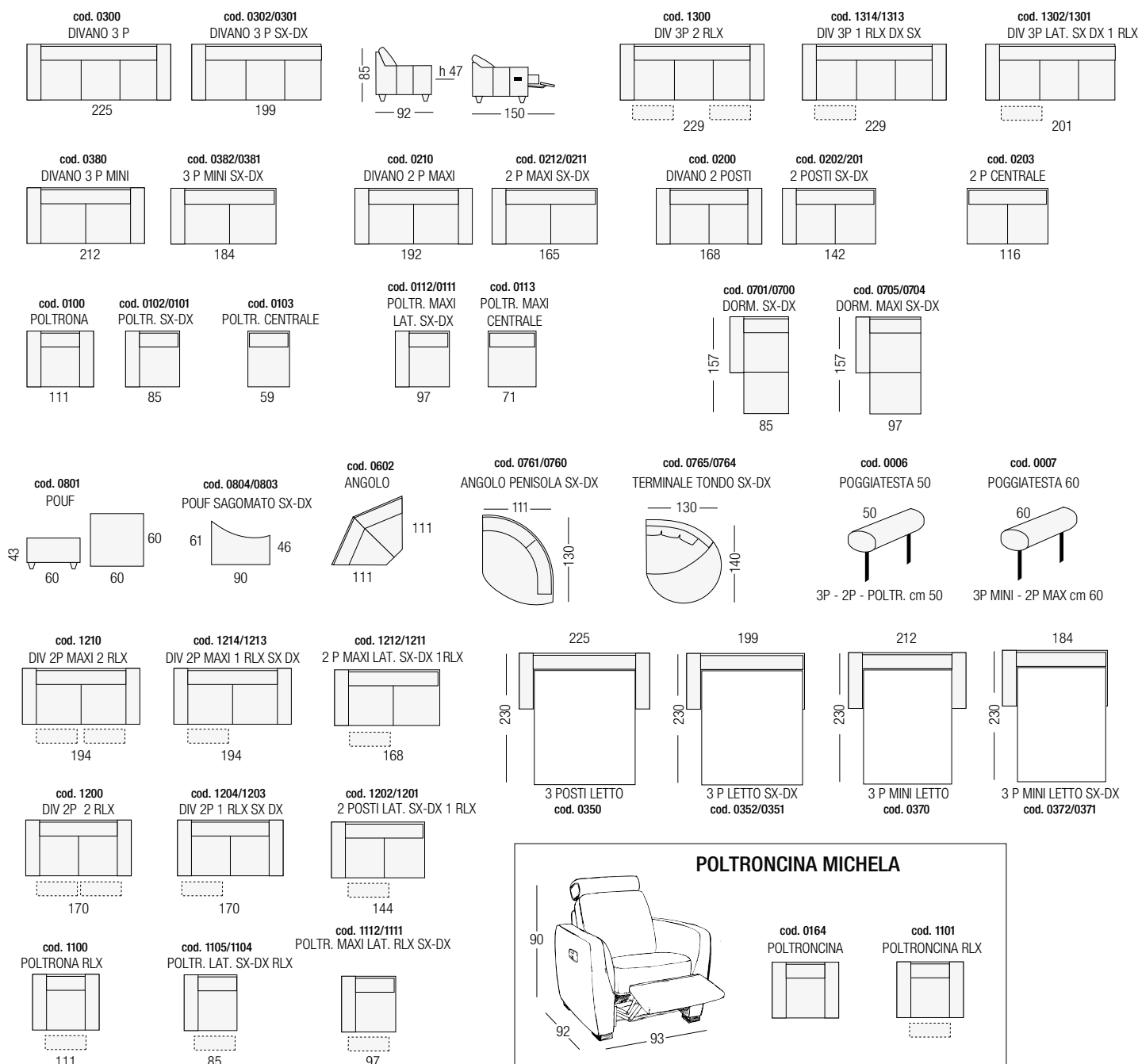

MARGOT

RIVESTIMENTO In pelle e microfibra non sfoderabile. Per le caratteristiche del rivestimento e la manutenzione vedere relative schede tecniche.

IMBOTTITURA Schienali e braccioli realizzati con poliuretano espanso di densità 25 kg/mc ricoperti di dacron resinato autoestinguente. Cuscini di seduta realizzati in poliuretano espanso di densità 35 kg/mc, ricoperti con falda di dacron resinato autoestinguente da 350 gr/mq.

PIEDI In legno da cm 5 color noce brunito e wengé.

STRUTTURA Realizzata in legno abbinato a particelle di legno grezzo biodegradabile e pannelli di fibra di legno duro.

VERSIONE LETTO Rete 2 pieghe elettrosaldata con aletta poggia guanciaie: divano 3 posti cm 150 x 187 compresa aletta; divano 3 posti mini cm 140 x 187 compresa aletta. Materasso in poliuretano espanso: divano 3 posti cm 130 x 165 x h 12;

divano 3 posti mini cm 120 x 165 x h 12. Nota: questo meccanismo è dotato di una aletta che consente di avere una profondità complessiva di circa 187 cm.

VERSIONE RLX Realizzato con meccanismo combinato con movimento schienale e poggiatesta. Disponibile sia manuale che elettrico con comando posizionato sul bracciolo laterale. L'elemento RLX è sempre staccato dall'elemento fisso e viene agganciato con apposito sistema a baionetta.

NOTE Il modello può essere realizzato in due versioni: fisso con cricchetto poggiatesta e RLX con cricchetto poggiatesta. Nella versione angolo lo schienale

COVERING Leather, microfiber or fabric. Not removable.

PADDING Ecologic polyurethane foam. Armrest and backrest cushion 25 kg/m3 covered with a Dacron layer. Seat cushion 35 kg/m3 covered with a Dacron layer 350gr/m2.

FEET Wood 5cm - color available dark walnut and wenge.

FRAME Hard wood combined with plywood and particle board covered with a dacron layer.

BED BASE Electro-welded 2-ply equipped with an extension for a total depth of 187cm. Bed base 3 seater 150x187*cm – bed base mini 3 seater 140x187* cm *including flap.

MATTRESS Spring or polyurethane foam mattress on demand (3 seater 130x165x12cm - mini 3 seater 120x165x12cm).

NOTE Model equipped with adjustable headrest. Corner version not available with adjustable headrest.

Manual or electric recliner available.

REVÊTEMENT Cuir, microfibre ou tissu non déhoussable.

REMBOURRAGE Dossier et accoudoir en polyuréthane écologique densité 25 kg/mc habillé d'un couche de dacron. Assise en polyuréthane écologique densité 35 kg/mc habillé d'un couche de dacron densité 350 gr/m2.

PIED En bois de 5cm teinté noyer bruni ou wengé.

STRUCTURE En bois massif, multiplis et particules habillés d'un couche de dacron.

SOMMIER Électro-soudé à 2 plis équipé avec un extension pour un profondeur total de 187cm. Sommier 3 places 150x187* - Sommier 3places mini 140x187* *extension inclus.

MATELAS À ressorts, sur demande en polyuréthane Matelas 3 places: 130x165x12 - Matelas 3 places mini: 120x165x12.

NOTE Modèle équipé avec tête réglable. La version angle n'est pas équipé avec tête réglable.

Mécanisme relax manuel ou électrique disponible.

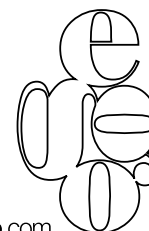
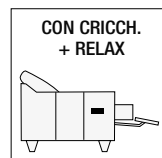
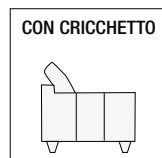
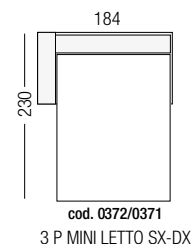
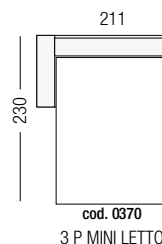
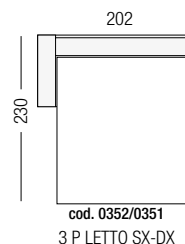
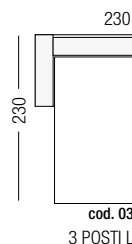
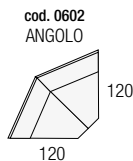
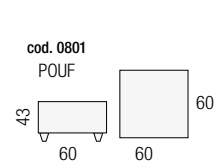
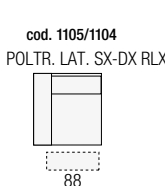
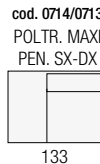
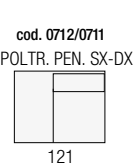
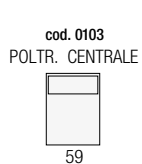
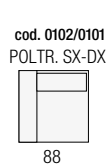
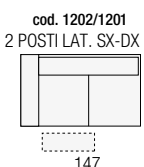
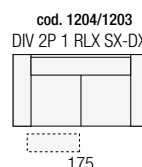
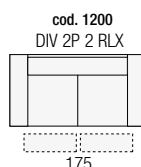
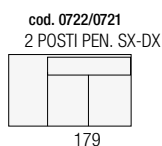
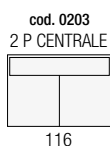
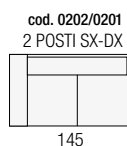
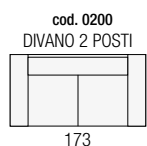
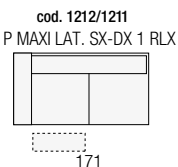
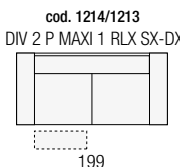
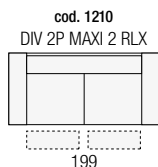
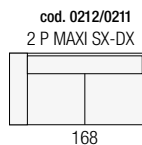
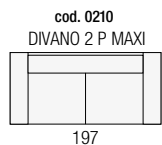
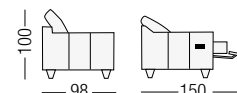
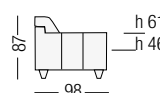
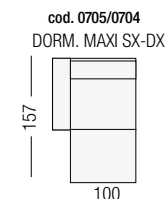
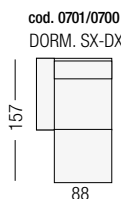
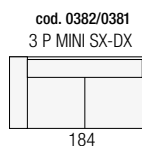
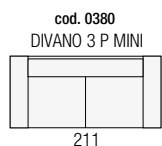
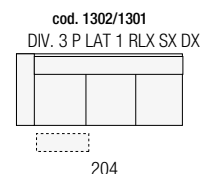
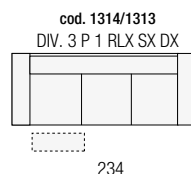
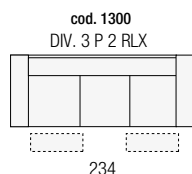
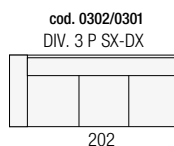
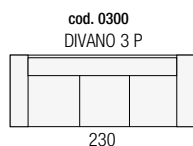

RIVESTIMENTO Pelle o microfibra non sfoderabile. Per le caratteristiche del rivestimento e la manutenzione vedere relative schede tecniche.

IMBOTTITURA Cuscini di seduta e braccioli in poliuretano espanso ecologico a densità differenziata. Cuscini di seduta di densità 30 kg/mc ricoperti con falda di dacron resinato da 100 gr/mq. Cuscini schienali realizzati in fibra di poliestere siliconata in fiocchi. Braccioli di densità 22 Kg/mc ricoperti da una termofalda di dacron autoestingente da 350 gr/mq.

PIEDI In Legno massello di faggio evaporato tinto con vernici ecologiche ad acqua, nei colori: Noce brunito, Wengè. H 4 cm.

STRUTTURA Realizzata in legno abbinato a particelle di legno grezzo biodegradabile e pannelli di fibra di legno duro.

RETE due pieghe elettrosaldata (3 POSTI 150x186), (2 P MAX 120x186).

MATERASSO a molle, optional in poliuretano espanso (3 POSTI 130x180x12), (2 P MAX 100x180x12).

NOTE Nella versione relax il modello è realizzato con meccanismo combinato con movimento schienale poggiatesta. Disponibile sia manuale che elettrico con comando posizionato sul bracciolo laterale. L'elemento relax è sempre staccato da quello fisso e viene agganciato con apposito sistema a baionetta.

COVERING Leather, microfiber or fabric. Not removable.

PADDING Seat cushion 30kg/m3 covered with a dacron layer 100gr/m2
Armrest 22kg/m3 covered with dacron layer 350gr/m2

Backrest cushion: siliconed polyester fibre

FEET Beech feet color dark walnut, wengè. H4cm

FRAME Hard wood combined with plywood and particle board covered with a dacron layer.

BASE Electro-welded 2-ply (3 seater 150x186cm, 2 seater maxi 120x186cm)

MATTRESS Spring, polyurethane on demand (3 seater 130x180x12cm, 2 seater maxi 100x180x12cm)

NOTE Manual and electric recliner available.

RETEMENT Cuir, microfibre ou tissu non déhoussable.

REMBOURRAGE Coussins d'assise et accoudeurs: polyuréthane écologique à densité différenciée. Coussins d'assise: 30kg/m3 recouverts d'une couche de Dacron résiné 100gr/m2. Dossiers: flocons de mousse. Accoudeurs: densité 22kg/m3 recouverts d'une couche de dacron 350gr/m2.

PIED hêtre massif, vernis écologiques: noyer bruni ou Wengè. H 4cm.

STRUCTURE Bois recouvert d'une couche de dacron.

SOMMIER Électro-soudé à 2 plis (3 places 150x186, 2p.max 120x186).

MATELAS À ressorts, sur demande en polyuréthane (3 places 130x180x12, 2p.max 100x180x12).

NOTE Dans la version relax le modèle est réalisé avec un mécanisme combiné dossier/repose-pieds. Disponible en manuel ou électrique avec commande sur l'accoudeur. L'élément relax est toujours détaché du fixe et est attaché à ce dernier par un système spécifique à baionette.

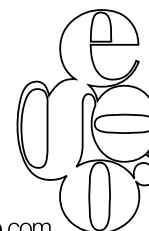
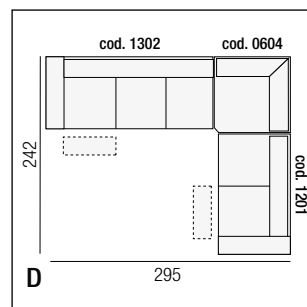
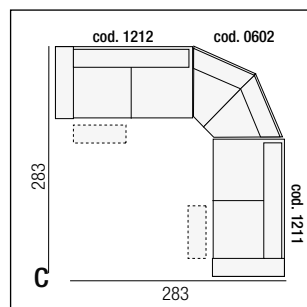
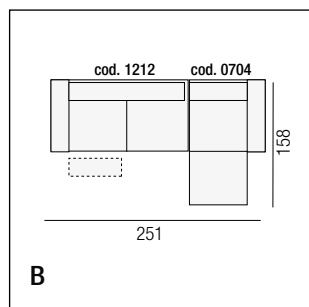
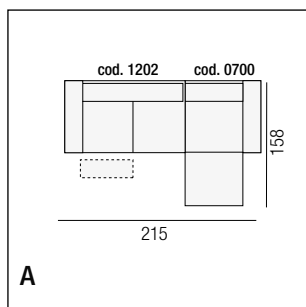
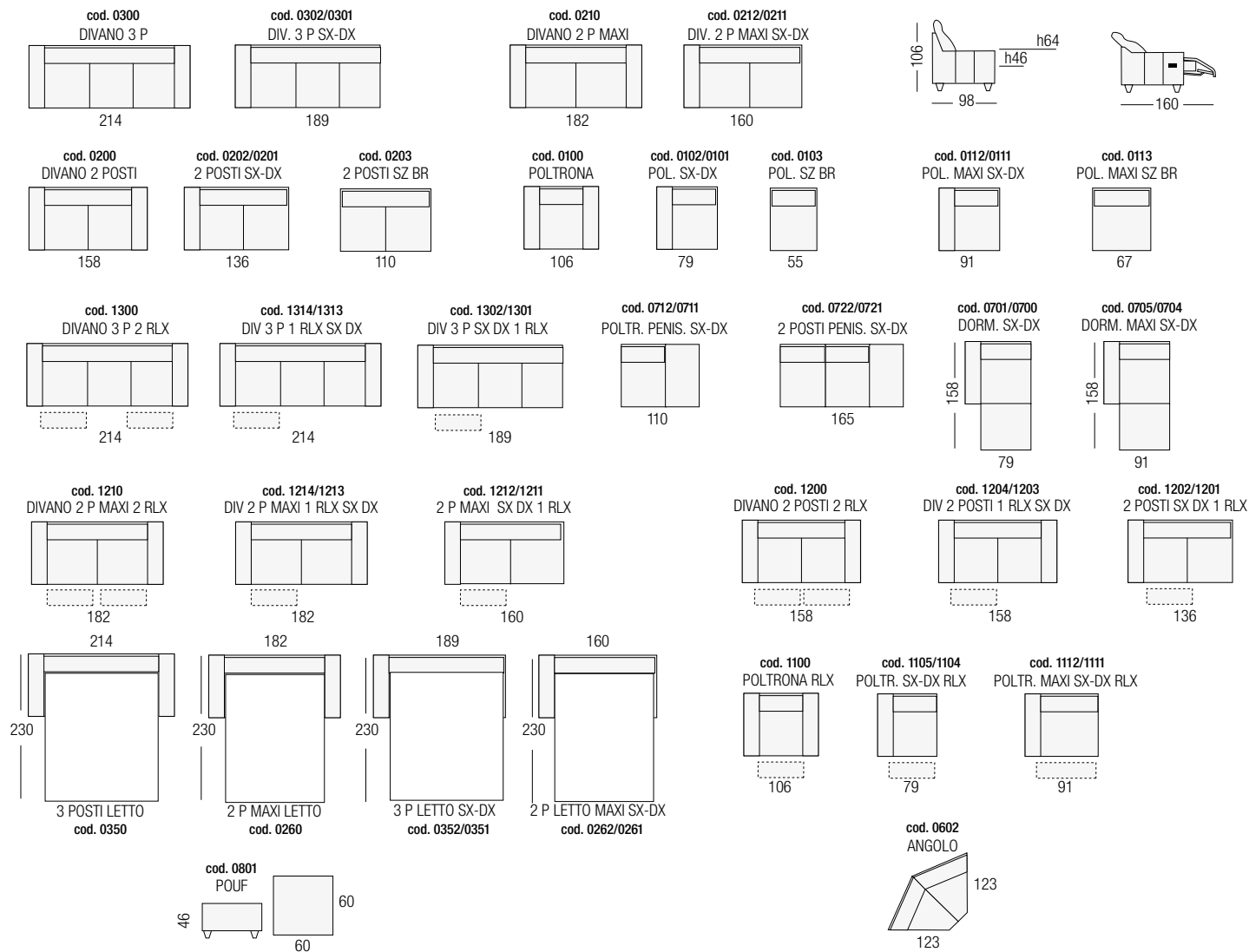

RIVESTIMENTO Pelle, tessuto, microfibra non sfoderabile. Per le caratteristiche del rivestimento e la manutenzione vedere relative schede tecniche.

IMBOTTITURA Cuscini di seduta, schienali e braccioli in poliuretano espanso ecologico a densità differenziata, ricoperti da trapunte imbottite in piume d'oca. Cuscini di seduta di densità 30 kg/mc sullo strato superiore e 35 kg/mc sullo strato inferiore. Schienali e braccioli di densità 30 kg/mc. La scocca dei divani è ricoperta da un doppio strato di dacron: primo strato resinato da 200 gr/mq; secondo strato in termofalda di dacron da 450 gr/mq.

PIEDI In acciaio tubolare cromato da cm 10,5.

STRUTTURA Realizzata in legno abbinato a particelle di legno grezzo biodegradabile e pannelli di fibra di legno duro.

NOTE Il modello è corredato di una base in acciaio tubolare cromato avente funzione puramente estetica e non portante. Nelle versioni con tavolino è possibile scegliere la finitura o l'essenza dei tavolini nelle seguenti opzioni: rovere tinto wengè, rovere tinto noce, rovere tinto noce brunito o rivestito in pelle.

COVERING Leather, microfiber or fabric. Not removable.

PADDING Armrest and backrest cushion: 30 kg/m3 ecologic polyurethane foam covered with down feather. Seat cushion: double density ecologic polyurethane foam. Bottom part 35 kg/m3 and upper part 30sc kg/m3.

All covered with down feather.

FEET Aluminium feet combined with chromium-plated steel base.

FRAME Hard wood combined with plywood and particle board covered with a dacron layer.

NOTE Side table available in different finishings: wengè, walnut, dark walnut or covered with leather.

REVELEMENT Cuir, microfibre ou tissu. Les revêtements sont fixes.

REMBOURRAGE Dossier et accoudoir: polyuréthane écologique avec densité 30 kg/m3 habillé de duvet. Assise en polyuréthane écologique avec double densité habillé de duvet. Partie inférieure 35kg/m3. Partie supérieure 30kg/m3.

PIED Aluminium brillant avec une base en acier chromé.

STRUCTURE En bois massif, multiplis et particules habillés d'un couche de dacron.

NOTE Composition avec petit table disponible avec finition wengè, noyer, noyer bruni et revêtu en cuir.

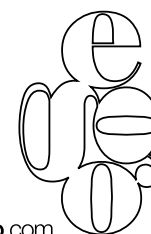
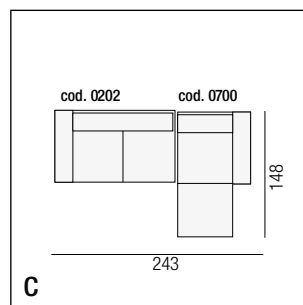
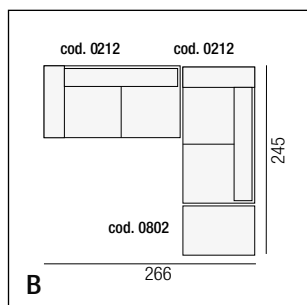
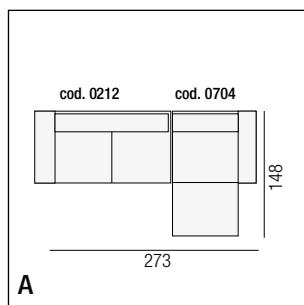
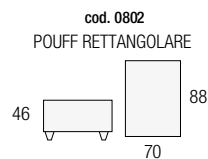
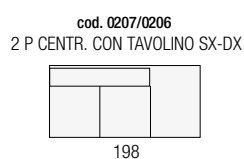
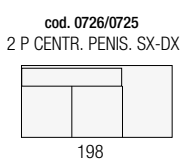
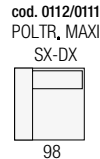
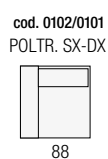
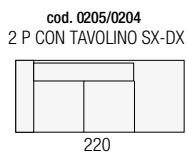
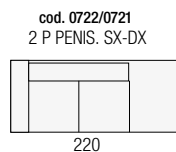
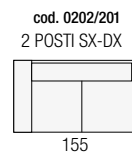
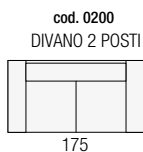
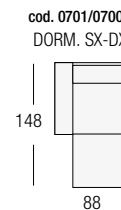
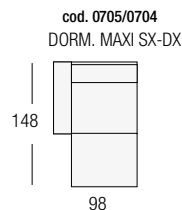
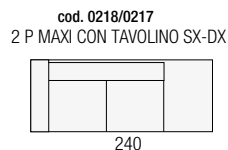
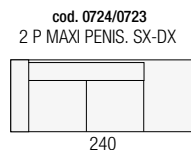
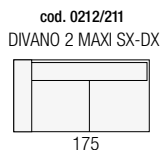
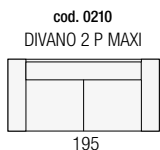
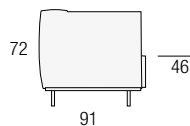
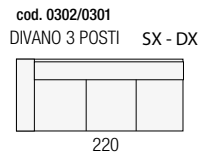
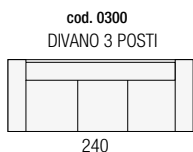

HERA

RIVESTIMENTO Pelle, tessuto o microfibra non sfoderabile. Per le caratteristiche del rivestimento e la manutenzione vedere relative schede tecniche.

IMBOTTITURA Cuscini di seduta, schienali e braccioli in poliuretano espanso ecologico a densità differenziata ricoperti da una doppia falda di dacron da 400 gr/mq. Cuscini di seduta di densità 35 kg/mc per lo strato inferiore e 30 kg/mc per lo strato superiore. Schienale poggiaresi di densità 22 kg/mc. Schienale testiera di densità 30 kg/mc. Parte superiore braccioli di densità 30 kg/mc. Parte anteriore e posteriore dei braccioli di densità 40 Kg/mc.

PIEDI In acciaio cromato o in legno massello di faggio evaporato tinto con vernici ecologiche ad acqua, nei colori: Noce, Noce brunito, Wengé.

STRUTTURA Realizzata in legno abbinato a particelle di legno grezzo biodegradabile e pannelli di fibra di legno duro.

NOTE Gli schienali sono dotati di meccanismo a cricchetto reclinabili a seconda del comfort desiderato. Nell'elemento angolo, gli schienali sono fissi e non reclinabili. Come indicato nei grafici, è possibile scegliere tra quattro differenti tipi di cuciture. L'aspetto volutamente "vissuto" e morbido è una caratteristica studiata sin dalla prima idea di progetto. Eventuali ed apparenti irregolarità nell'aspetto dell'imbottitura ed in generale dell'estetica dei divani sono quindi da considerarsi come il risultato della ricerca su materiali e lavorazioni artigianali altamente specializzate. Lo schienale lungo dell'elemento angolo pouf sx-dx è fisso e non reclinabile.

COVERING Leather, microfiber or fabric. Not removable.

PADDING Seat cushion, backrest and armrest: double density polyurethane foam covered with a Dacron layer 400 gr/m2.

Seat cushion: bottom part: 35kg/m3, upper part: 30 kg/m3. Backrest cushion 22kg/m3. Headrest: 30kg/m3. Armrest: Upper part:30kg/m3. Front and back 40kg/m3.

FEET Chromium-plated steel or beech feet. Available colours: walnut, dark walnut, wengé. Height: 4,5cm

FRAME Hard wood combined with plywood and particle board covered with a dacron layer.

NOTE Adjustable headrest not available on corner unit (cod.0602)

As shown in the graphics, you can choose among 4 different kind of stitching. The soft and "vintage look" of the model is strictly related to the research on materials and highly specialized craftsmanship.

REVÊTEMENT Cuir, microfibra ou tissu non déhoussable.

REMBOURRAGE Coussins d'assise, dossiers et accoudoirs en polyuréthane à densité différenciée recouverts d'une couche de Dacron de 400 gr/m2.

Coussins d'assise: densité 35 kg/m3 pour la partie inférieure et 30 kg/m3 pour la partie supérieure. Cale-reins: densité 22kg/m3. Dossiers partie supérieure: densité 30kg/m3

Accoudoirs: 30 kg/m3 pour la partie supérieure et 40 kg/m3 pour la partie inférieure et latérale.

PIED Acier chromé ou hêtre massif vernis écologiques: noyer, noyer bruni ou wengé. Hauteur 4,5 cm.

STRUCTURE En bois massif, multiplis et particules habillés d'une couche de dacron.

NOTE Les dossiers sont équipés d'un mécanisme manuel au niveau des appuis-tête, réclinables selon le confort désiré (sauf pour l'angle où les appuis-tête sont fixes). Comme indiqué sur les graphiques il est possible de choisir entre quatre types de coutures différentes.

L'aspect voulu "vécu" et moelleux est une caractéristique étudiée depuis le début du projet. Eventuelles et apparentes irrégularités dans l'aspect du rembourrage et en générale de l'esthétique des canapés sont donc à considérer comme le résultat de la recherche sur les matériaux et le travail artisanal hautement spécialisé.

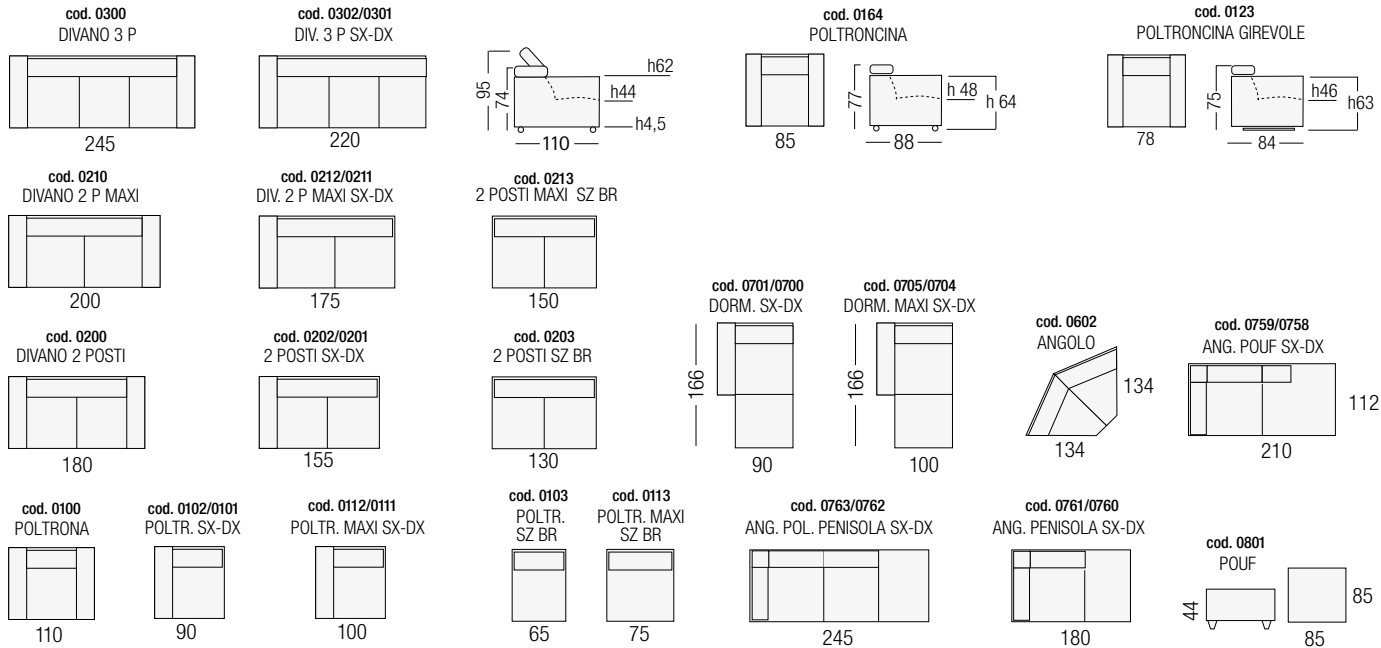

Hera
(taglio vivo)

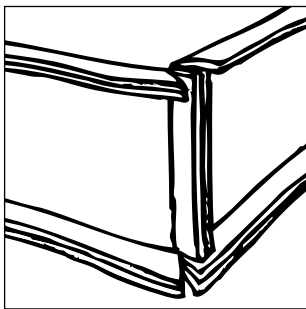

Hera 2
(cucitura a 9 mm)

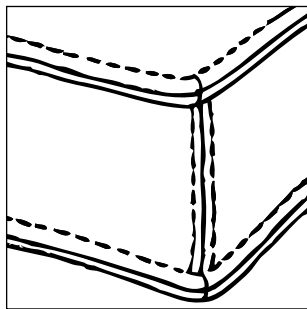

Hera 3
(cucitura a 2 aghi)

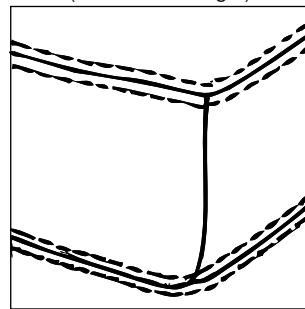

Hera 4
(bordino)

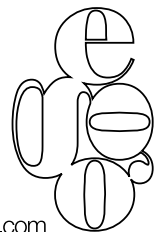
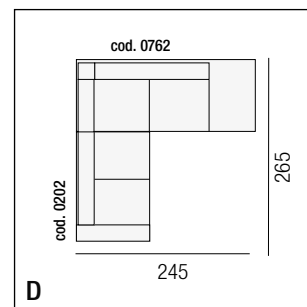
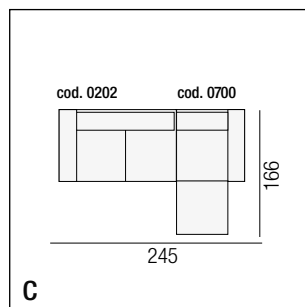
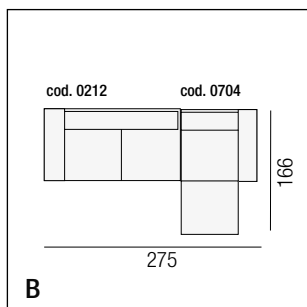
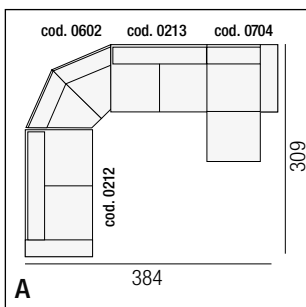
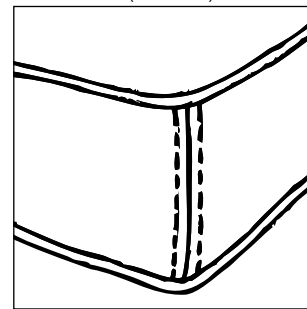

RIVESTIMENTO Pelle o microfibra non sfoderabile. Per le caratteristiche del rivestimento e la manutenzione vedere relative schede tecniche.

IMBOTTITURA Cuscini schienali realizzati in poliuretano espanso a doppia densità; parte superiore (schienale) di densità 28 Kg/mc, parte inferiore (poggiareni) di densità 23 Kg/mc. Cuscini di seduta realizzati in poliuretano espanso di densità 35 kg/mc con uno strato superiore di densità 30 Kg/mc. Schienali, poggiatesta e cuscini di seduta sono ricoperti con termofalda di dacron resinato autoestinguento da 450 gr/mq.

PIEDI In alluminio pressofuso e lucidato da cm 14.

STRUTTURA Realizzata in legno abbinato a particelle di legno grezzo biodegradabile e pannelli di fibra di legno duro.

NOTE Il modello è dotato di meccanismi a cricchetto che permettono di variare la posizione dell'estremità dei divani, assecondando così svariate esigenze di comfort. Tali meccanismi non sono presenti nelle versioni con penisola. Su richiesta è possibile dotare i divani di pratici poggiatesta.

COVERING Leather, microfiber or fabric. Not removable.

PADDING Backrest: double density ecologic polyurethane foam. Bottom part 23 kg/m3 density and upper part 28 kg/m3 density. Seat cushion: double density ecologic polyurethane foam. Bottom part 35 kg/m3 density and upper part 30 kg/m3 density. Seat and back cushion covered with 450 gr/m2 dacron layer.

FEET Polished aluminium.

FRAME Hard wood combined with plywood and particle board covered with a dacron layer.

NOTE Adjustable armrest not available on "lhf/rhf va one seater chaise" (code 0763/0762). All other versions are always equipped with adjustable armrests.

REVETEMENT Cuir, microfibra ou tissu. Les revêtements sont fixes.

REMBOURRAGE Dossier en polyuréthane écologique avec double densité. Partie supérieure 28kg/m3. Partie inférieure 23kg/m3. Assise en polyuréthane écologique avec double densité. Partie supérieure 30kg/m3. Partie inférieure 35kg/m3. Assise et dossier habillé d'un couche de dacron avec densité 450 gr/m2.

PIED Aluminium brillant.

STRUCTURE En bois massif, multiplis et particules habillés d'un couche de dacron.

NOTE Version angle méridienne (code 0763/0762) pas disponible avec mécanisme sur les accoudoirs.

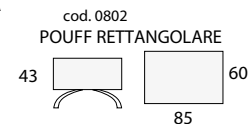
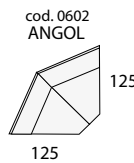
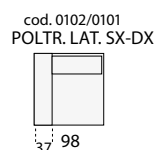
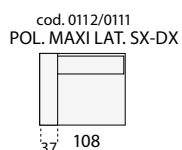
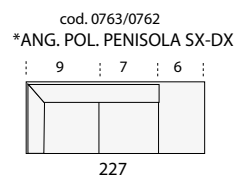
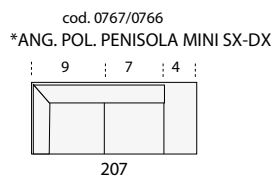
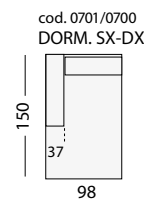
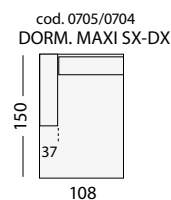
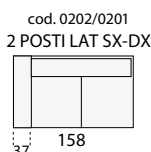
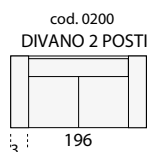
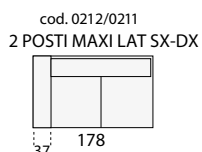
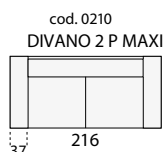
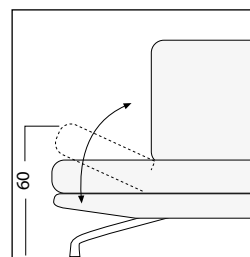
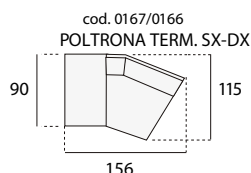
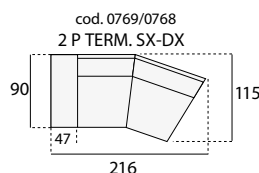
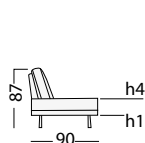

* LE VERSIONI CON ANGOLO POL. PENISOLA NON SONO DOTATE DI MECCANISMO NELLA PARTE TERMINALE

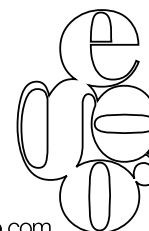
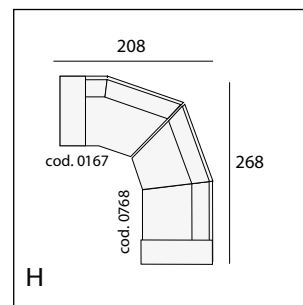
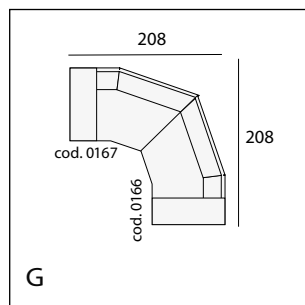
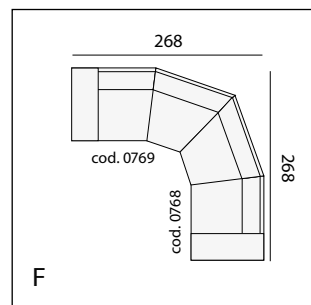
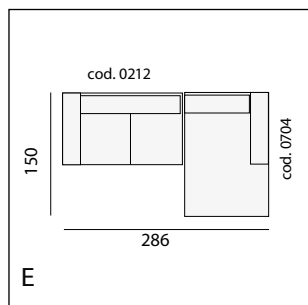
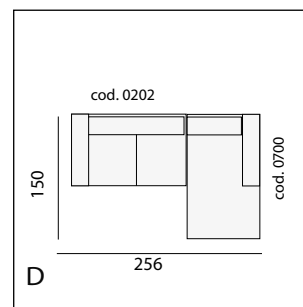
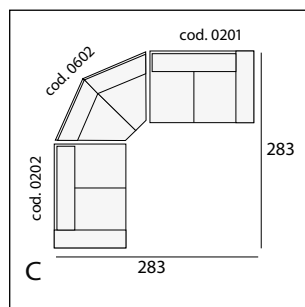
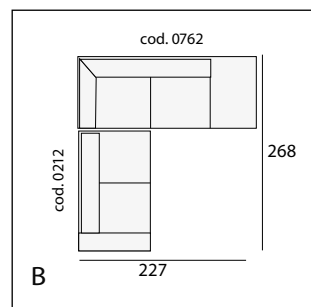
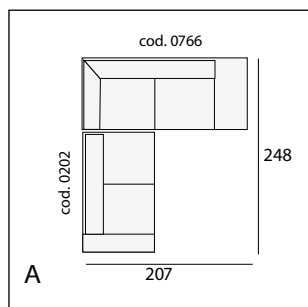

RIVESTIMENTO Pelle o microfibra, non sfoderabile. Per le caratteristiche del rivestimento e la manutenzione vedere relative schede tecniche.

IMBOTTITURA Cuscini di seduta e braccioli realizzati in poliuretano espanso. Cuscini di densità 30 kg/mc e braccioli di densità 23 kg/mc. Sia i cuscini che i braccioli sono ricoperti da una falda di dacron da 450 gr/mq. L'imbottitura degli schienali è realizzata in fiocchi di fibra poliestere siliconata, in involucro di tessuto non tessuto in fibra poliestere e polipropilene.

PIEDI In legno massello di faggio evaporato tinto con vernici ecologiche all' acqua, nei colori noce brunito o wengè. H cm 4.

STRUTTURA Realizzata in legno abbinato a particelle di legno grezzo biodegradabile e pannelli di fibra di legno duro.

RETE due pieghe elettrosaldata (3 POSTI 150x186), (2 P MAX 120x186).

MATERASSO a molle, optional in poliuretano espanso (3 POSTI 130x180x12), (2 P MAX 100x180x12).

COVERING Leather, microfiber or fabric. Not removable.

PADDING Ecologic polyurethane foam.

Seat cushion 30kg/m3 covered with a dacron layer 450gr/m2

Armrest 23kg/m3 covered with a dacron layer 450gr/m2

Backrest cushion: siliconed polyester fibre

FEET Beech feet available with dark walnut or wengé finishing. Height: 4cm

FRAME Hard wood combined with plywood and particle board covered with a dacron layer.

BED BASE Electro-welded 2-ply (3 seater 150x186cm, 2 seater maxi 120x186cm)

MATTRESS Spring or polyurethane on demand (3 seater 130x180x12cm, 2 seater maxi 100x180x12cm)

REVÊTEMENT Cuir, microfibre ou tissu non déhoussable.

REMBOURRAGE Coussins d'assise et accoudoirs en polyuréthane écologique

habillé d'un couche de dacron 450 gr/m2.

Coussins d'assise: 30kg/m3. Accoudoirs: 23 kg/m3.

Dossiers: flocons de mousse.

PIED Hêtre massif. Finition disponible: noyer bruni ou wengé. Hauteur 4cm.

STRUCTURE En bois massif, multiplis et particules habillés d'un couche de dacron.

SOMMIER Électro-soudé à 2 plis (3 places cm 150x186, 2places maxi 120x186)

MATELAS À ressorts, sur demande en polyuréthane (3 places 130x180x12, 2places maxi 100x180x12)

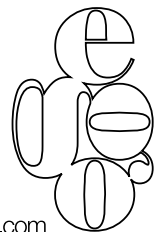
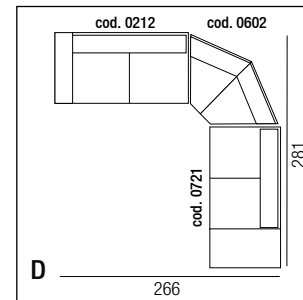
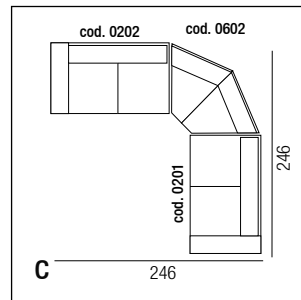
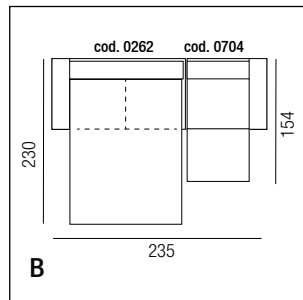
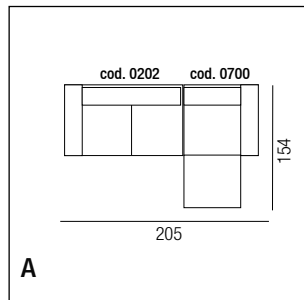
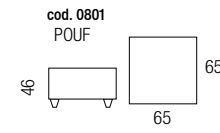
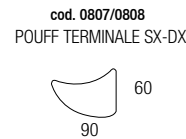
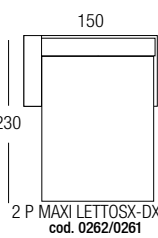
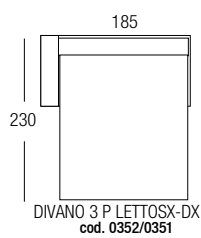
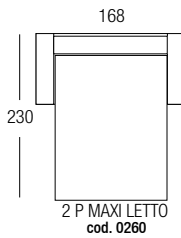
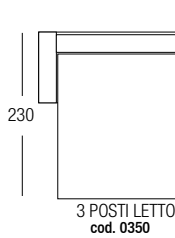
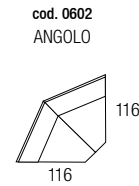
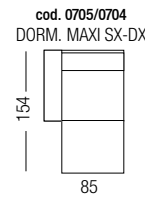
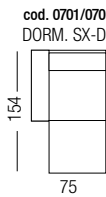
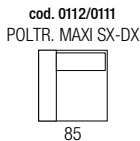
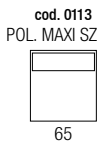
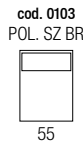
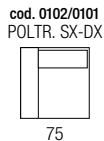
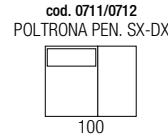
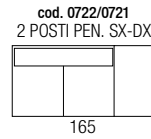
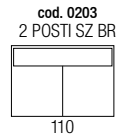
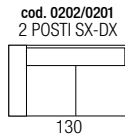
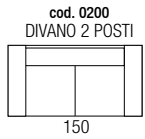
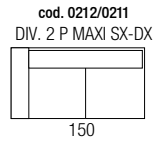
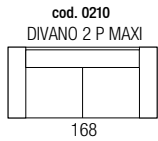
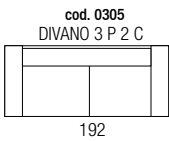
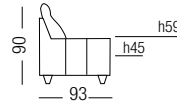
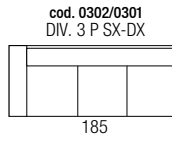
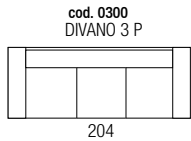

RIVESTIMENTO Pelle o microfibra, non sfoderabile. Per le caratteristiche del rivestimento e la manutenzione vedere relative schede tecniche.

IMBOTTITURA Cuscini di seduta e braccioli realizzati in poliuretano espanso. Cuscini di densità 30 kg/mc e braccioli di densità 23 kg/mc. Sia i cuscini che i braccioli sono ricoperti da una falda di dacron da 450 gr/mq. L'imbottitura degli schienali è realizzata in fiocchi di fibra poliestere siliconata, in involucro di tessuto non tessuto in fibra poliestere e polipropilene.

PIEDI In legno massello di faggio evaporato tinto con vernici ecologiche all' acqua, nei colori: noce brunito o wengè. H cm 4.

STRUTTURA Realizzata in legno abbinato a particelle di legno grezzo biodegradabile e pannelli di fibra di legno duro.

RETE due pieghe elettrosaldata (3 POSTI 150x186), (2 P MAX 120x186).

MATERASSO a molle, optional in poliuretano espanso (3 POSTI 130x180x12), (2 P MAX 100x180x12).

COVERING Leather, microfiber or fabric. Not removable.

PADDING Ecologic polyurethane foam.

Seat cushion 30kg/m3 covered with a dacron layer 450gr/m2

Armrest 23kg/m3 covered with a dacron layer 450gr/m2

Backrest cushion: siliconed polyester fibre

FEET Beech feet available with dark walnut or wengè finishing. Height: 4cm

FRAME Hard wood combined with plywood and particle board covered with a dacron layer.

BED BASE Electro-welded 2-ply (3 seater 150x186cm, 2 seater maxi 120x186cm)

MATTRESS Spring or polyurethane on demand (3 seater 130x180x12cm, 2 seater maxi 100x180x12cm)

REVÊTEMENT Cuir, microfibre ou tissu non déhoussable.

REMBOURRAGE Coussins d'assise et accoudoirs en polyuréthane écologique habillé d'un couche de dacron 450 gr/m2.

Coussins d'assise: 30kg/m3. Accoudoirs: 23 kg/m3.

Dossiers: flocons de mousse.

PIED Hêtre massif. Finition disponible: noyer bruni ou wengè. Hauteur 4cm.

STRUCTURE En bois massif, multiplis et particules habillés d'un couche de dacron.

SOMMIER Électro-soudé à 2 plis (3 places cm 150x186, 2places maxi 120x186)

MATELAS À ressorts, sur demande en polyuréthane (3 places 130x180x12, 2places maxi 100x180x12)

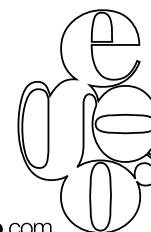
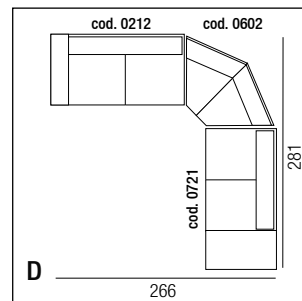
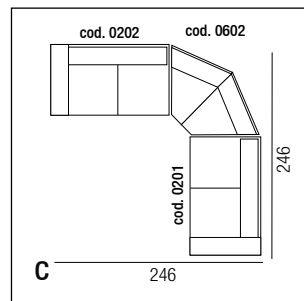
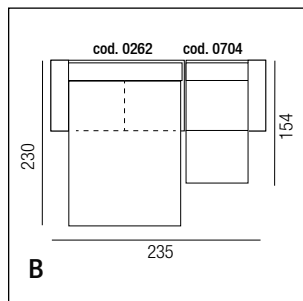
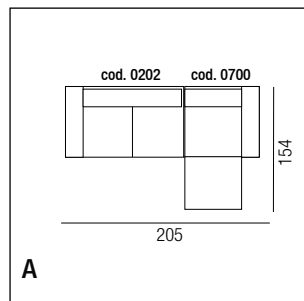
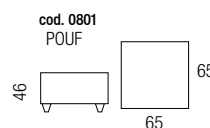
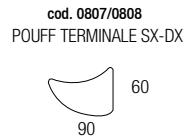
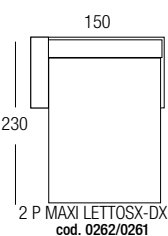
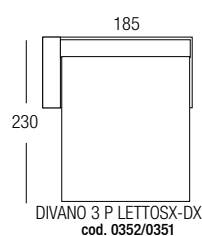
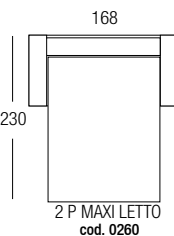
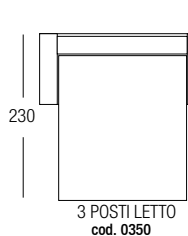
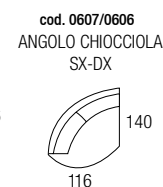
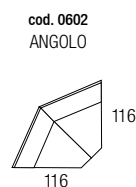
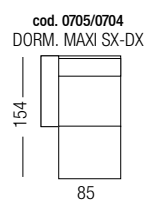
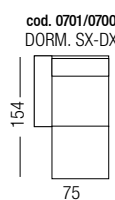
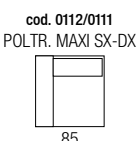
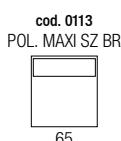
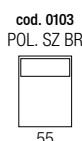
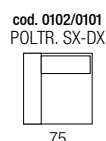
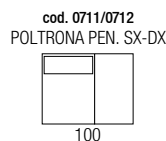
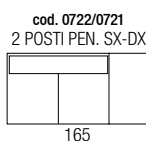
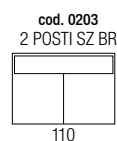
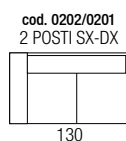
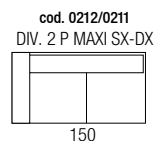
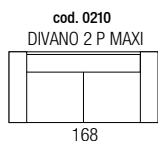
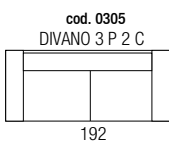
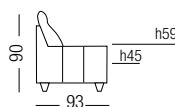
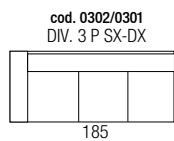
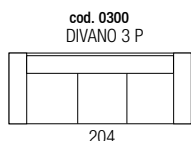

DORIANA

RIVESTIMENTO Pelle o microfibra non sfoderabile. Per le caratteristiche del rivestimento e la manutenzione vedere relative schede tecniche.

IMBOTTITURA Cuscini di seduta e braccioli in poliuretano espanso ecologico a densità differenziata. Cuscini di seduta di densità 30 kg/mc ricoperti con falda di dacron resinato da 100 gr/mq. Cuscini schienali realizzati in fibra di poliestere siliconata in fiocchi. Braccioli di densità 22 Kg/mc ricoperti da una termofalda di dacron autoestingente da 350 gr/mq.

PIEDI In Legno massello di faggio evaporato tinto con vernici ecologiche ad acqua, nei colori: Noce brunito, Wengè. H 4 cm.

STRUTTURA Realizzata in legno abbinato a particelle di legno grezzo biodegradabile e pannelli di fibra di legno duro.

RETE due pieghe elettrosaldata (3 POSTI 160x186), (2 P MAX 120x186).

MATERASSO a molle, optional in poliuretano espanso (3 POSTI 140x180x12), (2 P MAX 100x180x12).

NOTE Nella versione relax il modello è realizzato con meccanismo combinato con movimento schienale poggiatesta. Disponibile sia manuale che elettrico con comando posizionato sul bracciolo laterale. L'elemento relax è sempre staccato da quello fisso e viene agganciato con apposito sistema a baionetta.

COVERING Leather, microfiber or fabric. Not removable.

PADDING Seat cushion 30kg/m3 covered with a dacron layer 100gr/m2

Armrest 22kg/m3 covered with dacron layer 350gr/m2

Backrest cushion: siliconed polyester fibre

FEET Beech feet color dark walnut, wengè. H4cm

FRAME Hard wood combined with plywood and particle board covered with a dacron layer.

BASE Electro-welded 2-ply (3 seater 160x186cm, 2 seater maxi 120x186cm)

MATTRESS Spring, polyurethane on demand (3 seater 140x180x12cm, 2 seater maxi 100x180x12cm)

NOTE Manual and electric recliner available.

REVETEMENT Cuir, microfibre ou tissu non déhoussable.

REMBOURRAGE Coussins d'assise et accoudoirs: polyuréthane écologique à densité différenciée. Coussins d'assise: 30kg/m3 recouverts d'une couche de Dacron résiné 100gr/m2. Dossiers: flocons de mousse. Accoudoirs: densité 22kg/m3 recouverts d'une couche de dacron 350gr/m2.

PIED hêtre massif, vernis écologiques: noyer bruni ou Wengé. H 4cm.

STRUCTURE Bois recouvert d'une couche de dacron.

SOMMIER Électro-soudé à 2 plis (3 places 160x186, 2p.max 120x186).

MATELAS À ressorts, sur demande en polyuréthane (3 places 140x180x12, 2p.max 100x180x12).

NOTE Dans la version relax le modèle est réalisé avec un mécanisme combiné dossier/repose-pieds. Disponible en manuel ou électrique avec commande sur l'accoudoir. L'élément relax est toujours détaché du fixe et est attaché à ce dernier par un système spécifique à baionnette.

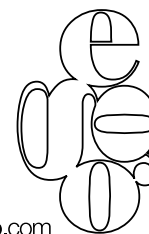
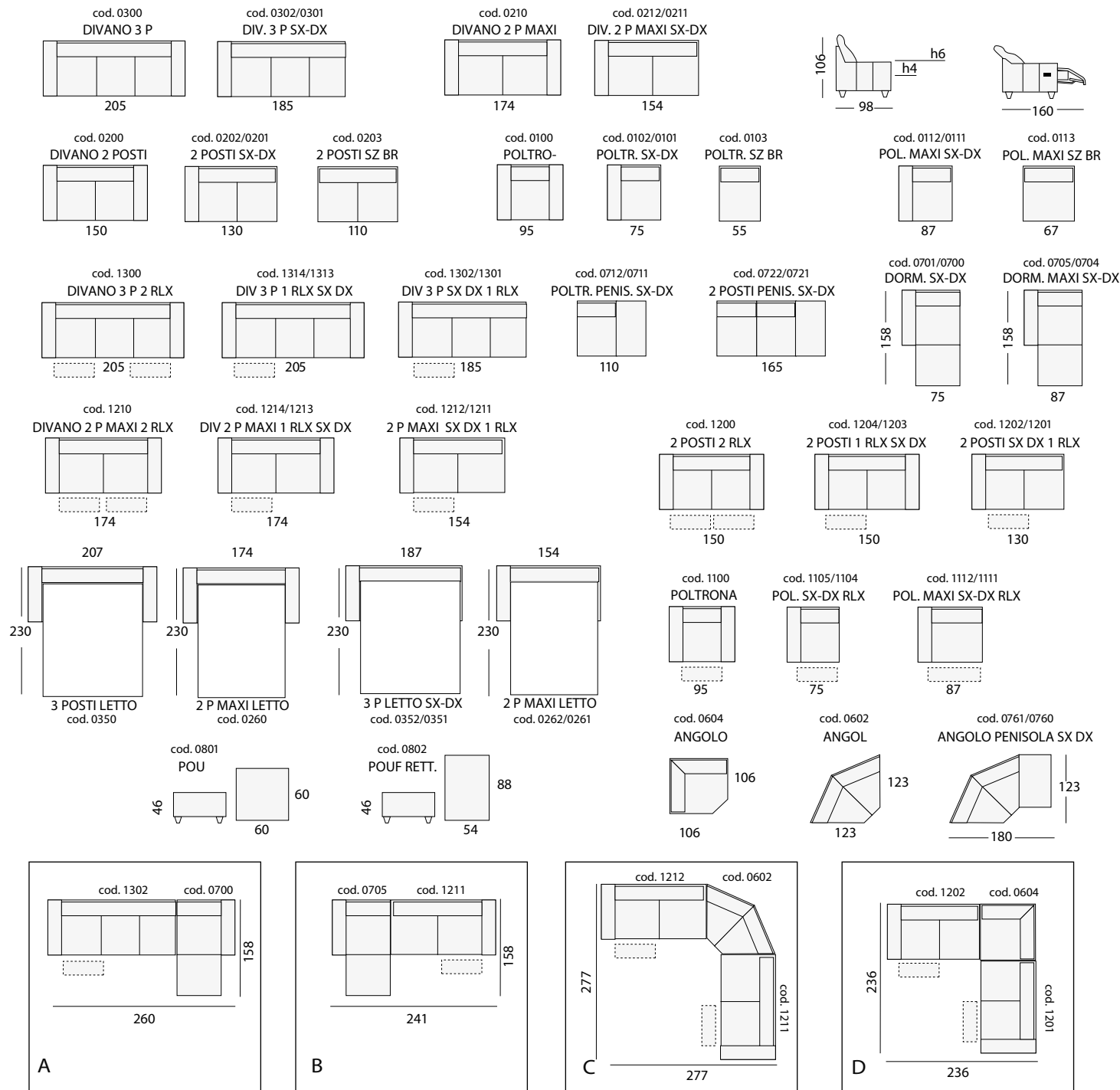

RIVESTIMENTO Pelle o microfibra non sfoderabile. Per le caratteristiche del rivestimento e la manutenzione, vedere relative schede tecniche.

IMBOTTITURA Cuscini di seduta, schienali e braccioli in poliuretano espanso a densità differenziata ricoperti da una doppia falda di dacron da 400 gr/mq. Cuscini di densità 35 kg/mc per lo strato inferiore e 30 kg/mc per lo strato superiore. Schienale poggianti di densità 22 kg/mc. Schienale testiera di densità 30 kg/mc. Parte superiore braccioli di densità 30 kg/mc. Parte anteriore e posteriore dei braccioli di densità 40 kg/mc.

PIEDI In legno wengé con profilo cromato, h 4 cm.

STRUTTURA Realizzata in legno abbinato a particelle di legno grezzo biodegradabile e pannelli di fibra di legno duro.

NOTE Gli schienali sono dotati di meccanismo manuale a cricchetto, reclinabili a seconda del comfort desiderato. Nella versione relax il modello è realizzato con meccanismo combinato movimento schienale poggiatesta, azionabile esclusivamente con comando elettrico a sfioramento, posizionato sul fianco interno del bracciolo. L'elemento relax è sempre staccato da quello fisso e viene agganciato con apposito sistema a baionetta. L'aspetto volutamente "vissuto" e morbido è una caratteristica studiata sin dalla prima idea di progetto. Eventuali ed apparenti irregolarità nell'aspetto dell'imbottitura ed in generale dell'estetica dei divani sono quindi da considerarsi come il risultato della ricerca su materiali e lavorazioni artigianali altamente specializzate.

COVERING Leather, microfiber or fabric. Not removable.

PADDING Varying density ecologic polyurethane foam covered with a double dacron layer 400 gr/m2. Seat cushion: Bottom part: 35 kg/m3. Upper part 30kg/m3. Backrest cushion: Bottom part: 22 kg/m3. Upper part 30kg/m3. Armrest: Upper part: 30kg/m3. Front and back 40kg/m3.

FEET Wengé feet with chromium-plated profile, h 4 cm.

FRAME Hard wood combined with plywood and particle board covered with a dacron layer.

NOTE Dominic is equipped with a manually adjustable headrest and an independent electric recliner mechanism with "soft-touch" button.

The soft and "vintage look" of the model is strictly related to the research on materials and highly specialized craftsmanship.

RETEMENT Cuir, microfibre ou tissu non déhoussable.

REMBOURRAGE Coussins d'assise, dossiers et accoudoirs en polyuréthane à densité différencié et recouverts d'une double couche de Dacron 400 gr/m2. Coussins d'assise: densité 35 kg/m3 pour la partie inférieure et 30 kg/m3 pour la partie supérieure. Dossier: densité 22 kg/m3, partie appui-tête 30 kg/m3.

Accoudoir: partie supérieure 30 kg/m3, partie antérieur et postérieur 40 kg/m3.

PIED En bois wengé avec profil chromé, h 4 cm.

STRUCTURE En bois massif, multiplis et particules habillés d'un couche de dacron.

NOTE Les dossiers sont équipés d'un mécanisme manuel au niveau des appuie-tête, réclinables selon le confort désiré. La version relax est réalisée avec un mécanisme combiné, mouvement dossier-repose pieds, actionnable exclusivement avec commande électrique à effleurlement positionné sur le coté interne de l'accoudoir. L'aspect voulu "vécu" et moelleux est une caractéristique étudiée depuis le début du projet. Eventuelles et apparentes irrégularités dans l'aspect du rembourrage et en générale de l'esthétique des canapés sont donc à considérer comme le résultat de la recherche sur les matériaux et le travail artisanal hautement spécialisé.

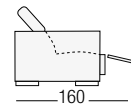
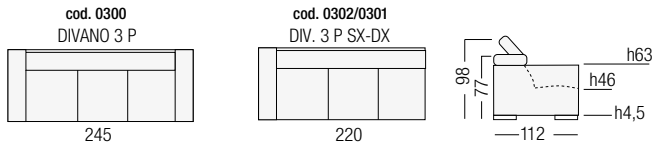

N.B. MECCANISMO RELAX AZIONABILE SOLO ELETTRICAMENTE.

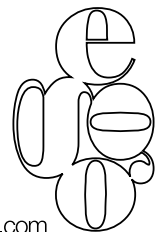
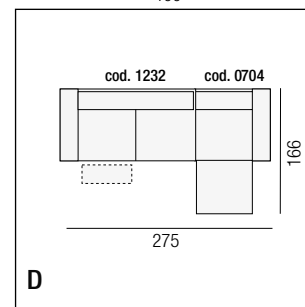
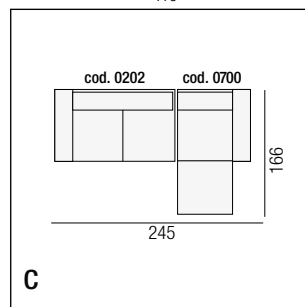
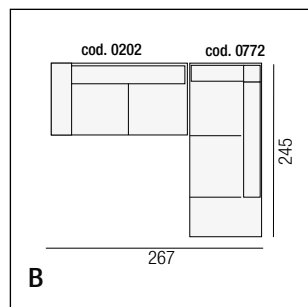
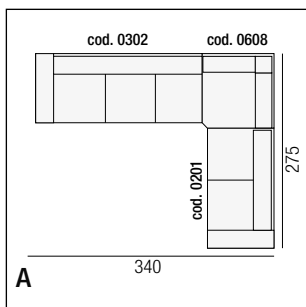
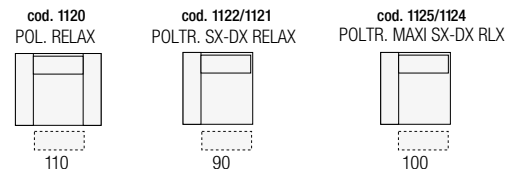
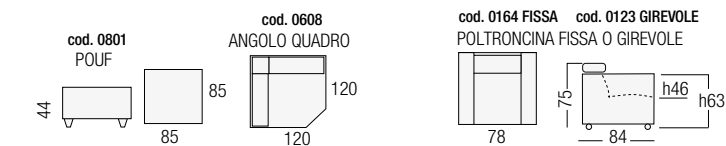
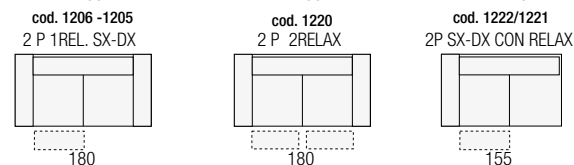
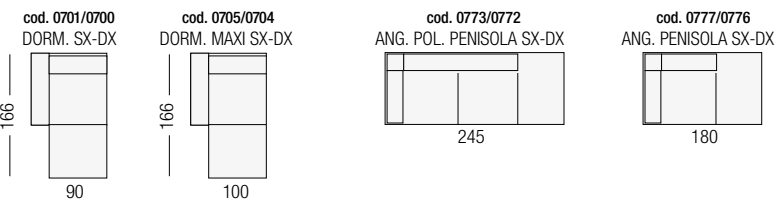
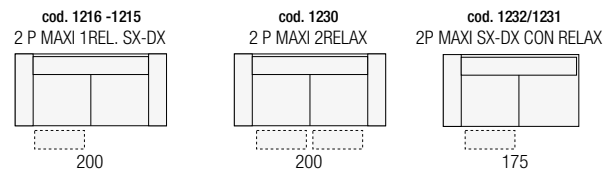
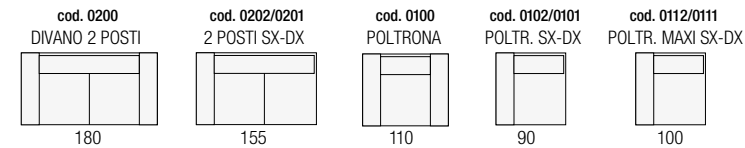
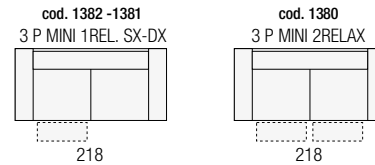
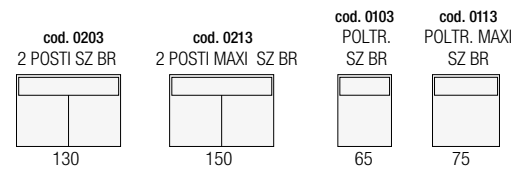
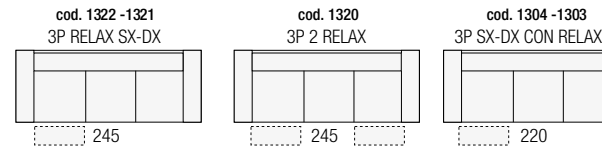
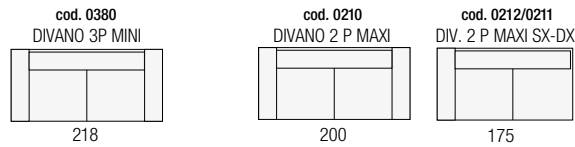

RIVESTIMENTO Pelle o microfibra non sfoderabile. Per le caratteristiche del rivestimento e la manutenzione, vedere relative schede tecniche.

IMBOTTITURA Cuscini di seduta, schienali e braccioli in poliuretano espanso a densità differenziata ricoperti da una doppia falda di dacron da 400 gr/mq. Cuscini di densità 35 kg/mc per lo strato inferiore e 30 kg/mc per lo strato superiore. Schienale poggiatesta di densità 22 kg/mc. Schienale testiera di densità 30 kg/mc. Parte superiore braccioli di densità 30 kg/mc. Parte anteriore e posteriore dei braccioli di densità 40 kg/mc.

PIEDI In legno wenge con profilo cromato, h 4 cm.

STRUTTURA Realizzata in legno abbinato a particelle di legno grezzo biodegradabile e pannelli di fibra di legno duro.

NOTE Gli schienali sono dotati di meccanismo manuale a cricchetto, reclinabili a seconda del comfort desiderato. Nella versione relax il modello è realizzato con meccanismo combinato movimento schienale poggiatesta, azionabile esclusivamente con comando elettrico a sfioramento, posizionato sul fianco interno del bracciolo. L'elemento relax è sempre staccato da quello fisso e viene agganciato con apposito sistema a baionetta. L'aspetto volutamente "vissuto" e morbido è una caratteristica studiata sin dalla prima idea di progetto. Eventuali ed apparenti irregolarità nell'aspetto dell'imbottitura ed in generale dell'estetica dei divani sono quindi da considerarsi come il risultato della ricerca su materiali e lavorazioni artigianali altamente specializzate.

COVERING Leather, microfiber or fabric. Not removable.

PADDING Varying density ecologic polyurethane foam covered with a double dacron layer 400 gr/m2. Seat cushion: Bottom part: 35 kg/m3. Upper part 30kg/m3. Backrest cushion: Bottom part: 22 kg/m3. Upper part 30kg/m3.

Armrest: Upper part: 30kg/m3. Front and back 40kg/m3.

FEET Wengé feet with chromium-plated profile, h 4 cm.

FRAME Hard wood combined with plywood and particle board covered with a dacron layer.

NOTE Dominic is equipped with a manually adjustable headrest and an independent electric recliner mechanism with "soft-touch" button.

The soft and "vintage look" of the model is strictly related to the research on materials and highly specialized craftsmanship.

REVEITEMENT Cuir, microfibre ou tissu non déhoussable.

REMBOURRAGE Coussins d'assise, dossiers et accoudoirs en polyuréthane à densité différencié et recouverts d'une double couche de Dacron 400 gr/m2
Coussins d'assise: densité 35 kg/m3 pour la partie inférieure et 30 kg/m3 pour la partie supérieure. Dossier: densité 22 kg/m3, partie appui-tête 30 kg/m3.

Accoudoir: partie supérieure 30 kg/m3, partie antérieure et postérieure 40 kg/m3.

PIED En bois wengé avec profil chromé, h 4 cm.

STRUCTURE En bois massif, multiplis et particules habillés d'un couche de dacron.

NOTE Les dossiers sont équipés d'un mécanisme manuel au niveau des appuie-tête, réclinables selon le confort désiré. La version relax est réalisée avec un mécanisme combiné, mouvement dossier-repose pieds, actionnable exclusivement avec commande électrique à effleurement positionné sur le coté interne de l'accoudoir. L'aspect voulu "vécu" et moelleux est une caractéristique étudiée depuis le début du projet. Eventuelles et apparentes irrégularités dans l'aspect du rembourrage et en générale de l'esthétique des canapés sont donc à considérer comme le résultat de la recherche sur les matériaux et le travail artisanal hautement spécialisé.

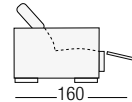
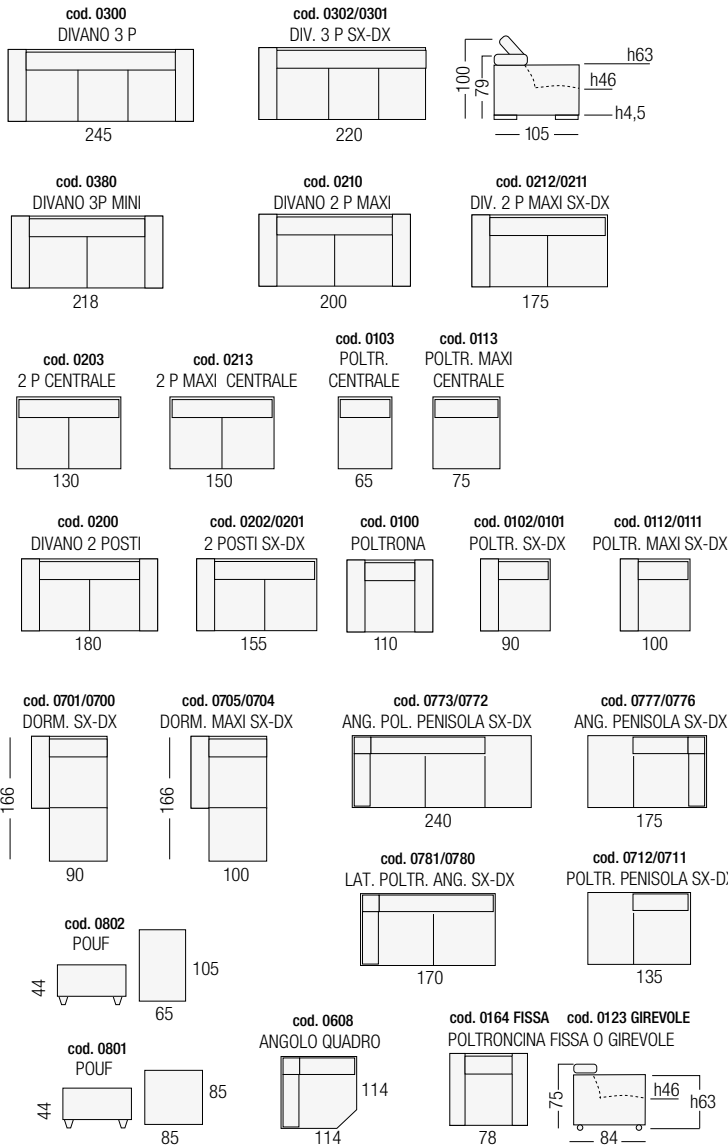

N.B. MECCANISMO RELAX AZIONABILE SOLO ELETTRICAMENTE.

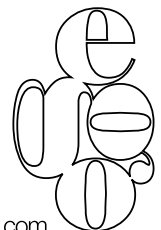
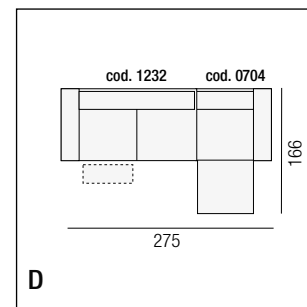
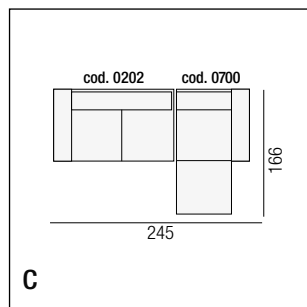
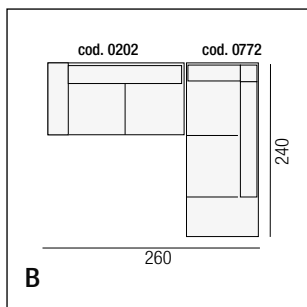
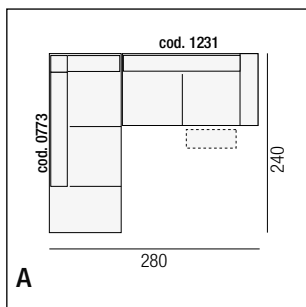
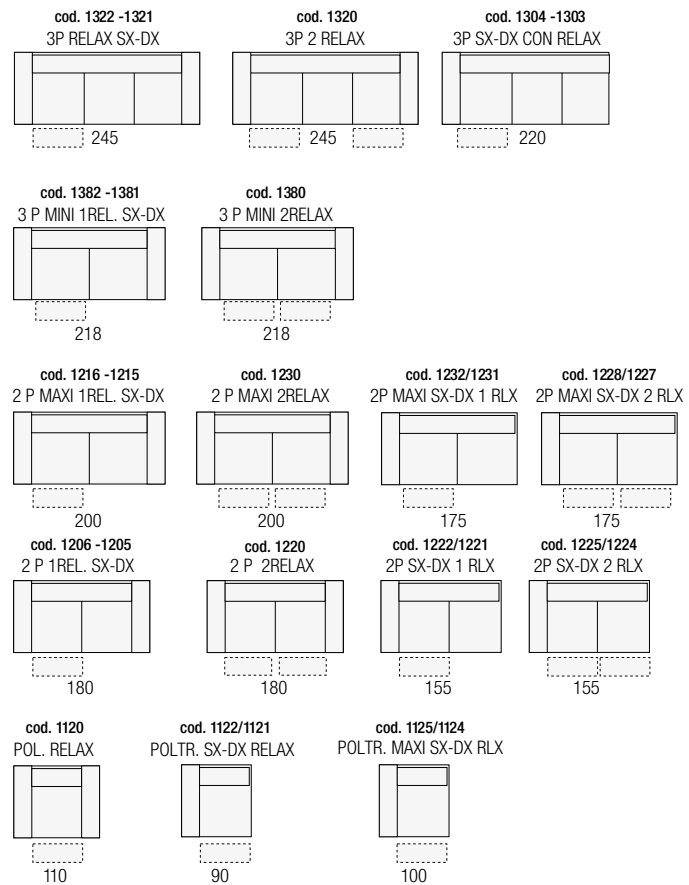

RIVESTIMENTO Pelle o microfibra non sfoderabile. Per le caratteristiche del rivestimento e la manutenzione, vedere relative schede tecniche.

IMBOTTITURA Cuscini di seduta, schienali e braccioli in poliuretano espanso a densità differenziata ricoperti da una doppia falda di dacron da 400 gr/mq. Cuscini di densità 35 kg/mc per lo strato inferiore e 30 kg/mc per lo strato superiore. Schienale poggiareni di densità 22 kg/mc. Schienale testiera di densità 30 kg/mc. Parte superiore braccioli di densità 30 kg/mc. Parte anteriore e posteriore dei braccioli di densità 40 kg/mc.

PIEDI In legno wengé con profilo cromato, h 4 cm.

STRUTTURA Realizzata in legno abbinato a particelle di legno grezzo biodegradabile e pannelli di fibra di legno duro.

NOTE Gli schienali sono dotati di meccanismo manuale a cricchetto, reclinabili a seconda del comfort desiderato. Nella versione relax il modello è realizzato con meccanismo combinato movimento schienale poggiapiedi, azionabile esclusivamente con comando elettrico a sfioramento, posizionato sul fianco interno del bracciolo. L'elemento relax è sempre staccato da quello fisso e viene agganciato con apposito sistema a baionetta. L'aspetto volutamente "vissuto" e morbido è una caratteristica studiata sin dalla prima idea di progetto. Eventuali ed apparenti irregolarità nell'aspetto dell'imbottitura ed in generale dell'estetica dei divani sono quindi da considerarsi come il risultato della ricerca su materiali e lavorazioni artigianali altamente specializzate.

COVERING Leather, microfiber or fabric. Not removable.

PADDING Varying density ecologic polyurethane foam covered with a double dacron layer 400 gr/m2. Seat cushion: Bottom part: 35 kg/m3. Upper part 30kg/m3. Backrest cushion: Bottom part: 22 kg/m3. Upper part 30kg/m3. Armrest: Upper part: 30kg/m3. Front and back 40kg/m3.

FEET Wengé feet with chromium-plated profile, h 4 cm.

FRAME Hard wood combined with plywood and particle board covered with a dacron layer.

NOTE Dominic is equipped with a manually adjustable headrest and an independent electric recliner mechanism with "soft-touch" button.

The soft and "vintage look" of the model is strictly related to the research on materials and highly specialized craftsmanship.

REVEITEMENT Cuir, microfibre ou tissu non déhoussable.

REMBOURRAGE Coussins d'assise, dossiers et accoudoirs en polyuréthane à densité différencié et recouverts d'une double couche de Dacron 400 gr/m2. Coussins d'assise: densité 35 kg/m3 pour la partie inférieure et 30 kg/m3 pour la partie supérieure. Dossier: densité 22 kg/m3, partie appui-tête 30 kg/m3. Accoudoir: partie supérieure 30 kg/m3, partie antérieur et postérieur 40 kg/m3.

PIED En bois wengé avec profil chromé, h 4 cm.

STRUCTURE En bois massif, multiplis et particules habillés d'un couche de dacron.

NOTE Les dossiers sont équipés d'un mécanisme manuel au niveau des appuie-tête, réclinables selon le confort désiré. La version relax est réalisée avec un mécanisme combiné, mouvement dossier-repose pieds, actionnable exclusivement avec commande électrique à effleurment positionné sur le coté interne de l'accoudoir. L'aspect voulu "vécu" et moelleux est une caractéristique étudiée depuis le début du projet. Eventuelles et apparentes irrégularités dans l'aspect du rembourrage et en générale de l'esthétique des canapés sont donc à considérer comme le résultat de la recherche sur les matériaux et le travail artisanal hautement spécialisé.

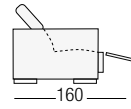
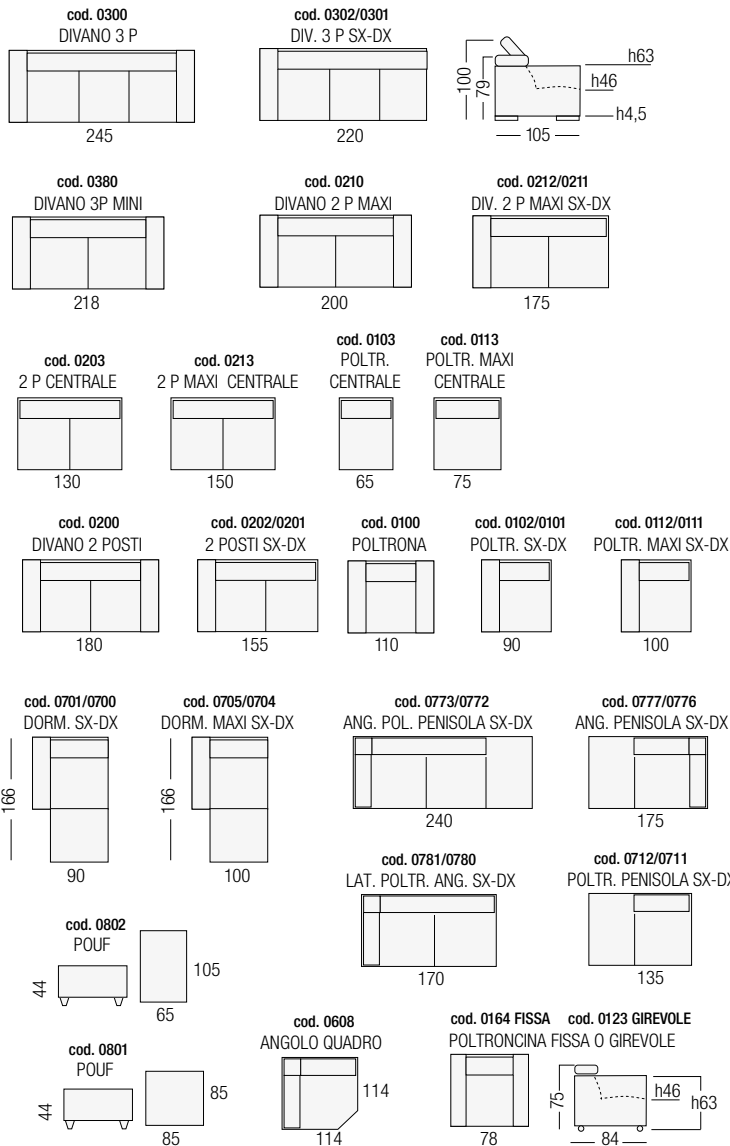

N.B. MECCANISMO RELAX AZIONABILE SOLO ELETTRICAMENTE.

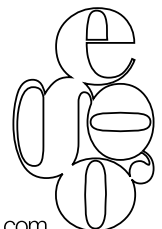
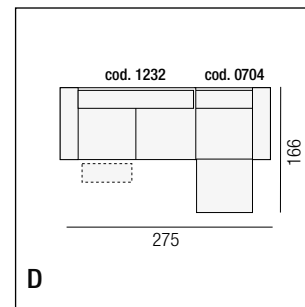
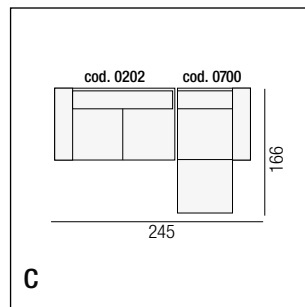
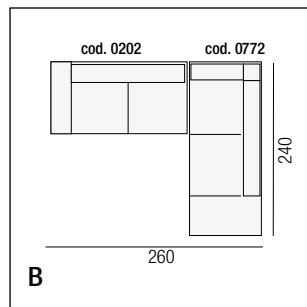
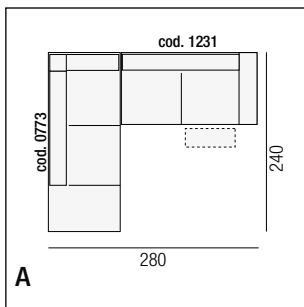
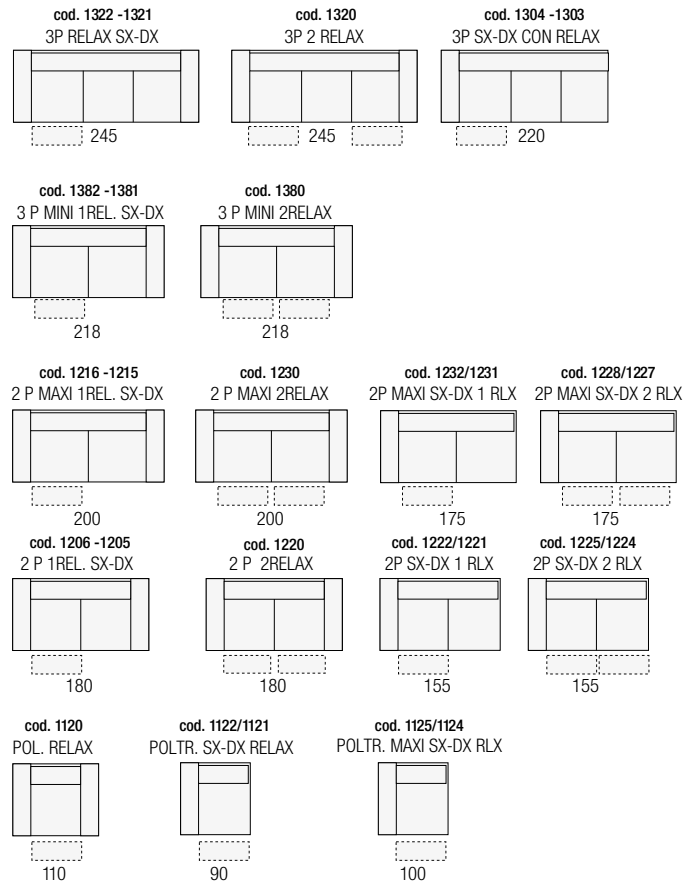

RIVESTIMENTO Pelle o microfibra non sfoderabile. Per le caratteristiche del rivestimento e la manutenzione vedere relative schede tecniche.

IMBOTTITURA Cuscini di seduta e braccioli in poliuretano espanso ecologico a densità differenziata. Cuscini di seduta di densità 30 kg/mc ricoperti con falda di dacron resinato da 100 gr/mq. Cuscini schienali realizzati in fibra di poliestere siliconata in fiocchi. Braccioli di densità 22 Kg/mc ricoperti da una termofalda di dacron autoestingente da 350 gr/mq.

PIEDI In Legno massello di faggio evaporato tinto con vernici ecologiche ad acqua, nei colori: Noce brunito, Wengè. H 4 cm.

STRUTTURA Realizzata in legno abbinato a particelle di legno grezzo biodegradabile e pannelli di fibra di legno duro.

RETE due pieghe elettrosaldata (3 POSTI 150x186), (2 P MAX 120x186).

MATERASSO a molle, optional in poliuretano espanso (3 POSTI 130x180x12), (2 P MAX 100x180x12).

NOTE Nella versione relax il modello è realizzato con meccanismo combinato con movimento schienale poggiatesta. Disponibile sia manuale che elettrico con comando posizionato sul bracciolo laterale. L'elemento relax è sempre staccato da quello fisso e viene agganciato con apposito sistema a baionetta.

COVERING Leather, microfiber or fabric. Not removable.

PADDING Seat cushion 30kg/m3 covered with a dacron layer 100gr/m2
Armrest 22kg/m3 covered with dacron layer 350gr/m2
Backrest cushion: siliconed polyester fibre

FEET Beech feet color dark walnut, wengè. H4cm

FRAME Hard wood combined with plywood and particle board covered with a dacron layer.

BASE Electro-welded 2-ply (3 seater 150x186cm, 2 seater maxi 120x186cm)

MATTRESS Spring, polyurethane on demand (3 seater 130x180x12cm, 2 seater maxi 100x180x12cm)

NOTE Manual and electric recliner available.

RETEMENT Cuir, microfibra ou tissu non déhoussable.

REMBOURRAGE Coussins d'assise et accoudoirs: polyuréthane écologique à densité différenciée. Coussins d'assise: 30kg/m3 recouverts d'une couche de Dacron résiné 100gr/m2. Dossiers: flocons de mousse. Accoudoirs: densité 22kg/m3 recouverts d'une couche de dacron 350gr/m2.

PIED hêtre massif, vernis écologiques: noyer bruni ou Wengé. H 4 cm.

STRUCTURE Bois recouvert d'une couche de dacron.

SOMMIER Electro-soudé à 2 plis (3 places 150x186, 2p.max 120x186).

MATELAS À ressorts, sur demande en polyuréthane (3 places 130x180x12, 2p.max 100x180x12).

NOTE Dans la version relax le modèle est réalisé avec un mécanisme combiné dossier/repose-pieds. Disponible en manuel ou électrique avec commande sur l'accoudoir. L'élément relax est toujours détaché du fixe et est attaché à ce dernier par un système spécifique à baionette.

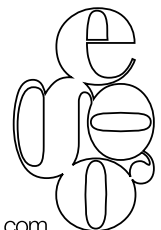
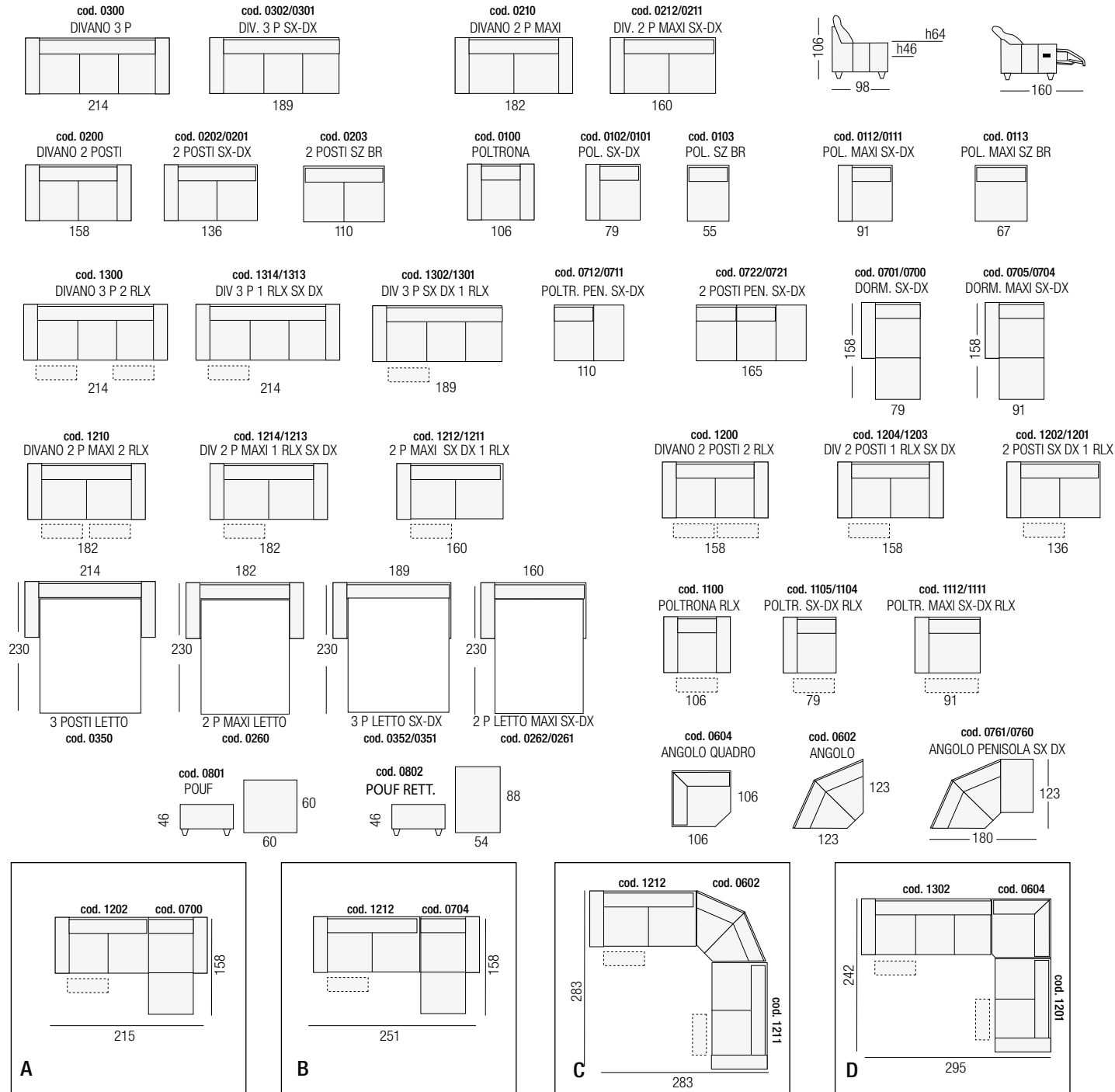

RIVESTIMENTO Pelle o microfibra non sfoderabile. Per le caratteristiche del rivestimento e la manutenzione vedere relative schede tecniche.

IMBOTTITURA Cuscini di seduta e braccioli in poliuretano espanso ecologico a densità differenziata. Cuscini di seduta di densità 30 kg/mc ricoperti con falda di dacron resinato da 100 gr/mq. Cuscini schienali realizzati in fibra di poliestere siliconata in fiocchi. Braccioli di densità 22 Kg/mc ricoperti da una termofalda di dacron autoestinguente da 350 gr/mq.

PIEDI In Legno massello di faggio evaporato tinto con vernici ecologiche ad acqua, nei colori: Noce brunito, Wengé. H 4 cm.

STRUTTURA Realizzata in legno abbinato a particelle di legno grezzo biodegradabile e pannelli di fibra di legno duro.

RETE due pieghe elettrosaldata (3 POSTI 150x186), (2 P MAX 120x186).

MATERASSO a molle, optional in poliuretano espanso (3 POSTI 130x180x12), (2 P MAX 100x180x12).

NOTE Nella versione relax il modello è realizzato con meccanismo combinato con movimento schienale poggiatesta. Disponibile sia manuale che elettrico con comando posizionato sul bracciolo laterale. L'elemento relax è sempre staccato da quello fisso e viene agganciato con apposito sistema a baionetta.

COVERING Leather, microfiber or fabric. Not removable.

PADDING Seat cushion 30kg/m3 covered with a dacron layer 100gr/m2

Armrest 22kg/m3 covered with dacron layer 350gr/m2

Backrest cushion: siliconed polyester fibre

FEET Beech feet color dark walnut, wengé. H4cm

FRAME Hard wood combined with plywood and particle board covered with a dacron layer.

BASE Electro-welded 2-ply (3 seater 150x186cm, 2 seater maxi 120x186cm)

MATTRESS Spring, polyurethane on demand (3 seater 130x180x12cm, 2 seater maxi 100x180x12cm)

NOTE Manual and electric recliner available.

RETEVEMENT Cuir, microfibre ou tissu non déhoussable.

REMBOURRAGE Coussins d'assise et accoudoirs: polyuréthane écologique à densité différenciée. Coussins d'assise: 30kg/m3 recouverts d'une couche de Dacron résiné 100gr/m2. Dossiers: flocons de mousse. Accoudoirs: densité 22kg/m3 recouverts d'une couche de dacron 350gr/m2.

PIED hêtre massif, vernis écologiques: noyer bruni ou Wengé. H 4cm.

STRUCTURE Bois recouvert d'une couche de dacron.

SOMMIER Électro-soudé à 2 plis (3 places 150x186, 2p.max 120x186).

MATELAS À ressorts, sur demande en polyuréthane (3 places 130x180x12, 2p.max 100x180x12).

NOTE Dans la version relax le modèle est réalisé avec un mécanisme combiné dossier/repose-pieds. Disponible en manuel ou électrique avec commande sur l'accoudoir. L'élément relax est toujours détaché du fixe et est attaché à ce dernier par un système spécifique à baionnette.

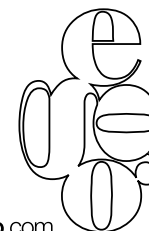
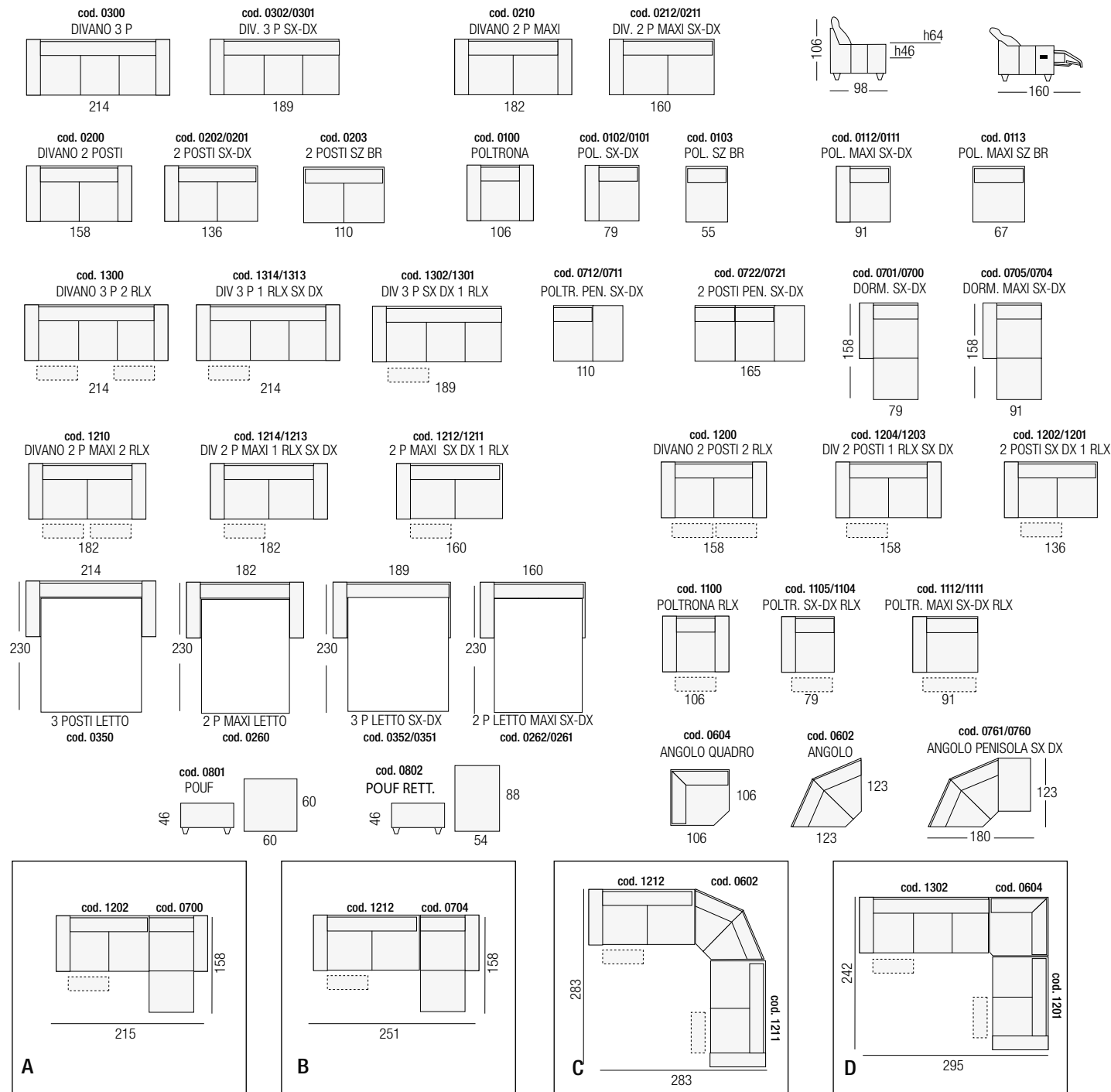

RIVESTIMENTO Pelle o microfibra non sfoderabile. Per le caratteristiche del rivestimento e la manutenzione vedere relative schede tecniche.

IMBOTTITURA Cuscini di seduta e braccioli in poliuretano espanso ecologico a densità differenziata. Cuscini di seduta di densità 30 kg/mc ricoperti con falda di dacron resinato da 100 gr/mq. Cuscini schienali realizzati in fibra di poliestere siliconata in fiocchi. Braccioli di densità 22 Kg/mc ricoperti da una termofalda di dacron autoestingente da 350 gr/mq.

PIEDI In Legno massello di faggio evaporato tinto con vernici ecologiche ad acqua, nei colori: Noce brunito, Wengè. H 4 cm.

STRUTTURA Realizzata in legno abbinato a particelle di legno grezzo biodegradabile e pannelli di fibra di legno duro.

RETE due pieghe elettrosaldata (3 POSTI 160x186), (2 P MAX 120x186).

MATERASSO a molle, optional in poliuretano espanso (3 POSTI 140x180x12), (2 P MAX 100x180x12).

NOTE Nella versione relax il modello è realizzato con meccanismo combinato con movimento schienale poggiapiedi. Disponibile sia manuale che elettrico con comando posizionato sul bracciolo laterale. L'elemento relax è sempre staccato da quello fisso e viene agganciato con apposito sistema a baionetta.

COVERING Leather, microfiber or fabric. Not removable.

PADDING Seat cushion 30kg/m3 covered with a dacron layer 100gr/m2
Armrest 22kg/m3 covered with dacron layer 350gr/m2
Backrest cushion: siliconed polyester fibre

FEET Beech feet color dark walnut, wengé. H4cm

FRAME Hard wood combined with plywood and particle board covered with a dacron layer.

BASE Electro-welded 2-ply (3 seater 160x186cm, 2 seater maxi 120x186cm)

MATTRESS Spring, polyurethane on demand (3 seater 140x180x12cm, 2 seater maxi 100x180x12cm)

NOTE Manual and electric recliner available.

REVETEMENT Cuir, microfibra ou tissu non déhoussable.

REMBOURRAGE Coussins d'assise et accoudoirs: polyuréthane écologique à densité différenciée. Coussins d'assise: 30kg/m3 recouverts d'une couche de Dacron résiné 100gr/m2. Dossiers: flocons de mousse. Accoudoirs: densité 22kg/m3 recouverts d'une couche de dacron 350gr/m2.

PIED hêtre massif, vernis écologiques: noyer bruni ou Wengé. H 4cm.

STRUCTURE Bois recouvert d'une couche de dacron.

SOMMIER Électro-soudé à 2 plis (3 places 160x186, 2p.max 120x186).

MATELAS À ressorts, sur demande en polyuréthane (3 places 140x180x12, 2p.max 100x180x12).

NOTE Dans la version relax le modèle est réalisé avec un mécanisme combiné dossier/repose-pieds. Disponible en manuel ou électrique avec commande sur l'accoudoir. L'élément relax est toujours détaché du fixe et est attaché à ce dernier par un système spécifique à baionnette.

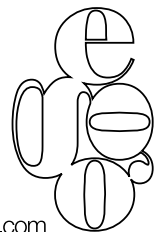
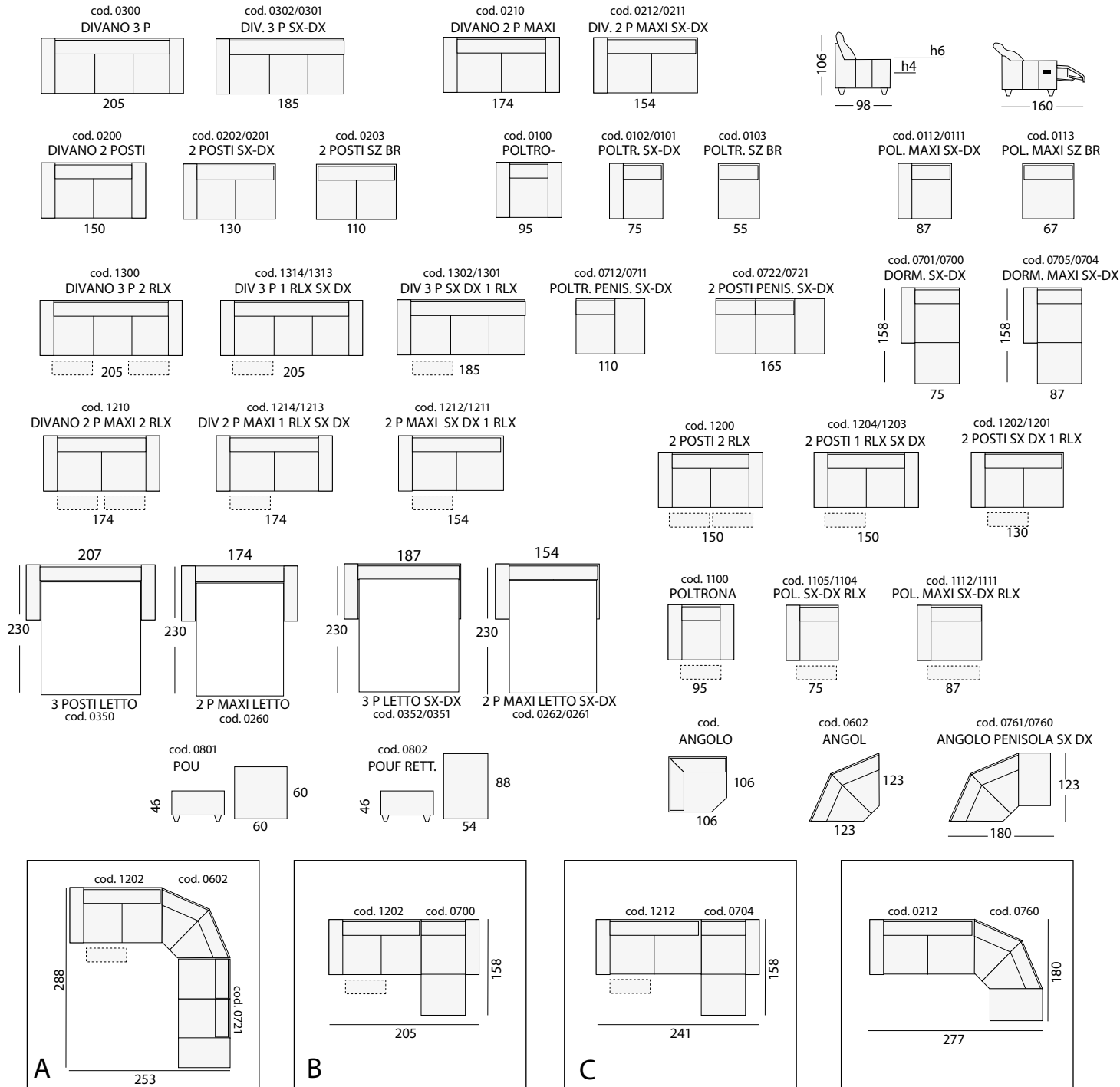

RIVESTIMENTO Pelle, tessuto o microfibra non sfoderabile. Per le caratteristiche del rivestimento e la manutenzione vedere relative schede tecniche.

IMBOTTITURA Cuscino di seduta realizzato in poliuretano espanso a doppia densità: sottocuscino di densità 45 kg/mc, sopracuscino di densità 35 kg/mc. Imbottiture di completamento in poliuretano espanso di densità 45 kg/mc ricoperte da una falda di tomana (ovatta resinata accoppiata con tessuto non tessuto).

PIEDI La poltroncina è dotata di ruote o piedini in ABS.

STRUTTURA Realizzata in legno abbinato a particelle di legno grezzo biodegradabile e pannelli di fibra di legno duro.

COVERING Leather, microfiber or fabric. Not removable.

PADDING Double density ecologic polyurethane foam.

Seat cushion: upper part 35 kg/m3 bottom part: 45 kg/m3.

Frame and backrest cushions: polyurethane foam 45kg/m3 covered with a layer of cotton wood coupled with "non-woven" fabric.

FEET Abs plastic feet or little wheels.

FRAME Hard wood combined with plywood and particle board covered with a dacron layer.

REVÊTEMENT Cuir, microfibre ou tissu non déhoussable.

REMBOURRAGE Coussins d'assise en polyuréthane écologique à densité différenciée: densité 45 kg/m3 pour la partie inférieure et 35 kg/m3 pour la partie supérieure.

Structure et accouoir en polyuréthane écologique densité 45 kg/m3 habillé par une couche de dacron accouplé avec tissu "non-woven"

PIED Roulettes ou pieds en matière plastique (ABS)

STRUCTURE En bois massif, multiplis et particules habillés d'un couche de dacron.

cod. 0164

POLTRONCINA

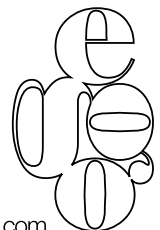
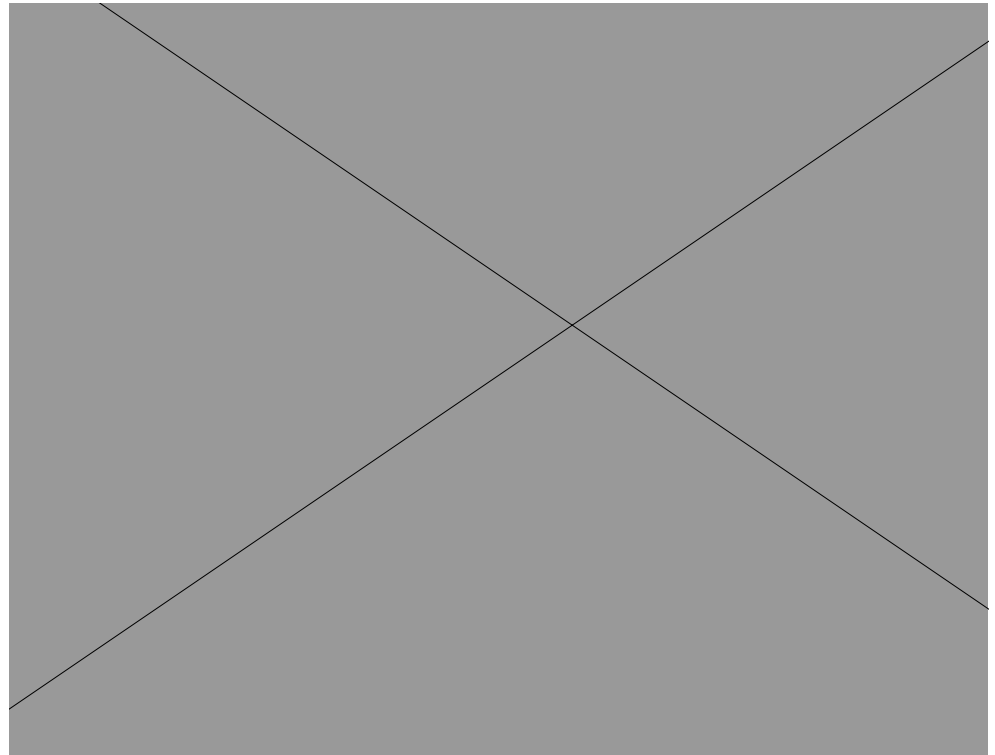
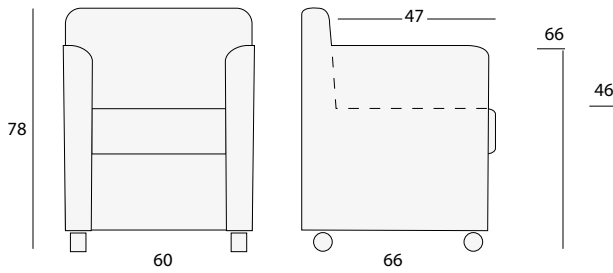

RIVESTIMENTO Pelle o microfibra non sfoderabile. Per le caratteristiche del rivestimento e la manutenzione vedere relative schede tecniche.

IMBOTTITURA Cuscini di seduta e braccioli in poliuretano espanso ecologico a densità differenziata. Cuscini di seduta di densità 30 kg/mc ricoperti con falda di dacron resinato da 100 gr/mq. Cuscini schienali realizzati in fibra di poliestere siliconata in fiocchi. Braccioli di densità 22 Kg/mc ricoperti da una termofalda di dacron autoestingente da 350 gr/mq.

PIEDI In Legno massello di faggio evaporato tinto con vernici ecologiche ad acqua, nei colori: Noce brunito, Wengè. H 4 cm.

STRUTTURA Realizzata in legno abbinato a particelle di legno grezzo biodegradabile e pannelli di fibra di legno duro.

RETE due pieghe elettrosaldada (3 POSTI 150x186), (2 P MAX 120x186).

MATERASSO a molle, optional in poliuretano espanso (3 POSTI 130x180x12), (2 P MAX 100x180x12).

NOTE Nella versione relax il modello è realizzato con meccanismo combinato con movimento schienale poggiatesta. Disponibile sia manuale che elettrico con comando posizionato sul bracciolo laterale. L'elemento relax è sempre staccato da quello fisso e viene agganciato con apposito sistema a baionetta.

COVERING Leather, microfiber or fabric. Not removable.

PADDING Ecologic polyurethane foam.

Seat cushion 30kg/m3 covered with a dacron layer 100gr/m2

Armrest 22kg/m3 covered with dacron layer 350gr/m2

Backrest cushion: siliconed polyester fibre

FEET Beech feet color dark walnut, wengè. H4cm

FRAME Hard wood combined with plywood and particle board covered with a dacron layer.

BASE Electro-welded 2-ply (3 seater 150x186cm, 2 seater maxi 120x186cm)

MATTRESS Spring, polyurethane on demand (3 seater 130x180x12cm, 2 seater maxi 100x180x12cm)

NOTE Manual and electric recliner available.

REVETEMENT Cuir, microfibre ou tissu non déhoussable.

REMBOURRAGE Coussins d'assise et accouvoirs: polyuréthane écologique à densité différenciée. Coussins d'assise: 30kg/m3 recouverts d'une couche de Dacron résiné 100gr/m2. Dossiers: flocons de mousse. Accouvoirs: densité 22kg/m3 recouverts d'une couche de dacron 350gr/m2.

PIED hêtre massif, vernis écologiques: noyer bruni ou Wengè. H 4cm.

STRUCTURE Bois recouvert d'une couche de dacron.

SOMMIER Électro-soudé à 2 plis (3 places 150x186, 2p.max 120x186).

MATELAS À ressorts, sur demande en polyuréthane (3 places 130x180x12, 2p.max 100x180x12).

NOTE Dans la version relax le modèle est réalisé avec un mécanisme combiné dossier/repose-pieds. Disponible en manuel ou électrique avec commande sur l'accouvoir. L'élément relax est toujours détaché du fixe et est attaché à ce dernier par un système spécifique à baionetta.

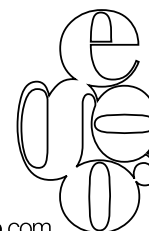
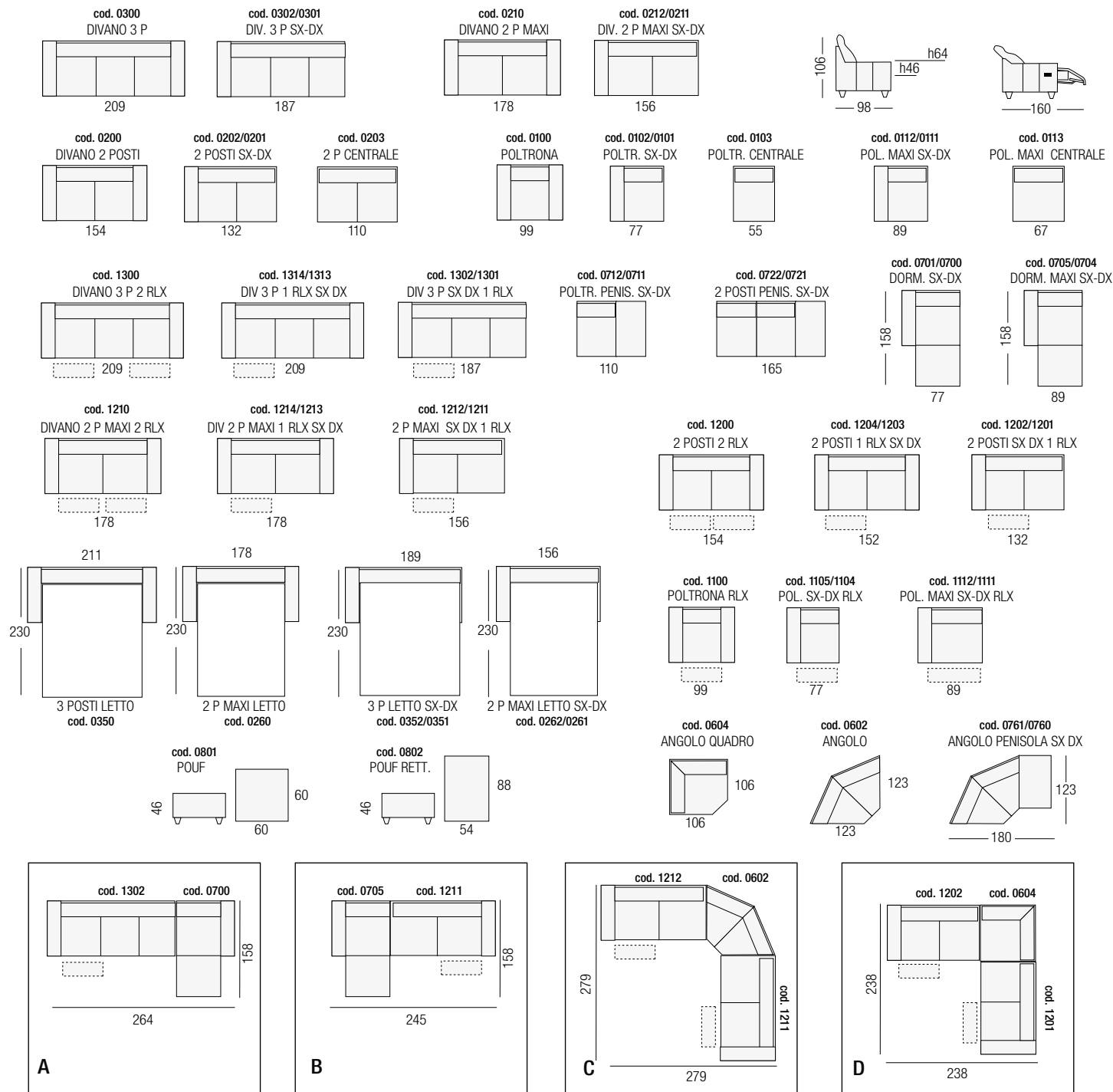

RIVESTIMENTO Pelle o microfibra, non sfoderabile. Per le caratteristiche del rivestimento e la manutenzione vedere relative schede tecniche.

IMBOTTITURA Cuscini di seduta e braccioli realizzati in poliuretano espanso. Cuscini di densità 30 kg/mc e braccioli di densità 23 kg/mc. Sia i cuscini che i braccioli sono ricoperti da una falda di dacron da 450 gr/mq. L'imbottitura degli schienali è realizzata in fiocchi di fibra poliestere siliconata, in involucro di tessuto non tessuto in fibra poliestere e polipropilene.

PIEDI In legno massello di faggio evaporato tinto con vernici ecologiche all'acqua, nei colori: noce brunito o wengè. H cm. 4.

STRUTTURA Realizzata in legno abbinato a particelle di legno grezzo biodegradabile e pannelli di fibra di legno duro.

RETE due pieghe elettrosaldata (3 POSTI 150x186), (2 P MAX 120x186).

MATERASSO a molle, optional in poliuretano espanso (3 POSTI 130x180x12), (2 P MAX 100x180x12).

COVERING Leather, microfiber or fabric. Not removable.

PADDING Ecologic polyurethane foam.

Seat cushion 30kg/m3 covered with a dacron layer 450gr/m2

Armrest 23kg/m3 covered with a dacron layer 450gr/m2

Backrest cushion: siliconed polyester fibre

FEET Beech feet available with dark walnut or wengè finishing. Height: 4cm

FRAME Hard wood combined with plywood and particle board covered with a dacron layer.

BED BASE Electro-welded 2-ply (3 seater 150x186cm, 2 seater maxi 120x186cm)

MATTRESS Spring or polyurethane on demand (3 seater 130x180x12cm, 2 seater maxi 100x180x12cm)

REVÊTEMENT Cuir, microfibre ou tissu non déhoussable.

REMBOURRAGE Coussins d'assise et accoudoirs en polyuréthane écologique habillé d'un couche de dacron 450 gr/m2.

Coussins d'assise: 30kg/m3. Accoudoirs: 23 kg/m3.

Dossiers: flocons de mousse.

PIED Hêtre massif. Finition disponible: noyer bruni ou wengè. Hauteur 4cm.

STRUCTURE En bois massif, multiplis et particules habillés d'un couche de dacron.

SOMMIER Électro-soudé à 2 plis (3 places cm 150x186, 2places maxi 120x186)

MATELAS À ressorts, sur demande en polyuréthane (3 places 130x180x12, 2places maxi 100x180x12)

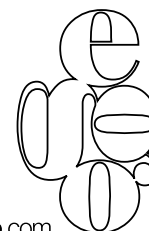
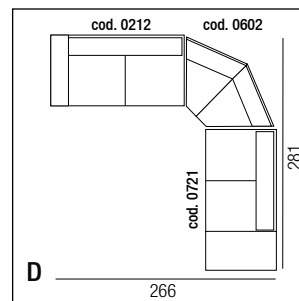
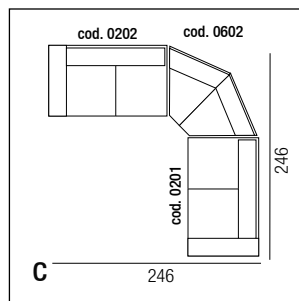
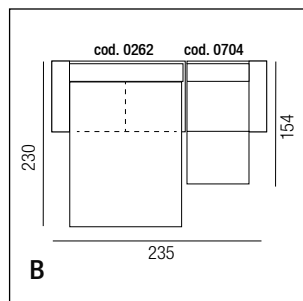
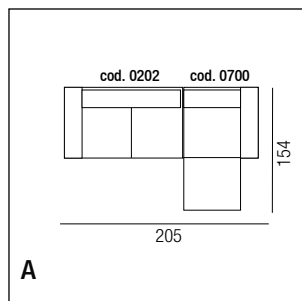
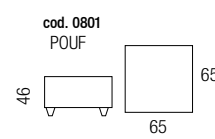
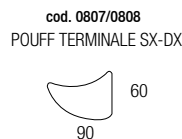
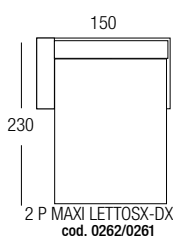
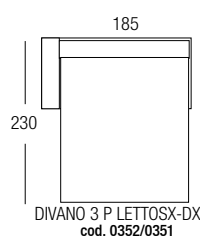
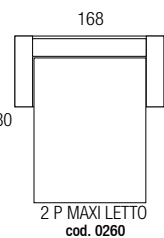
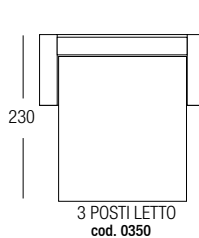
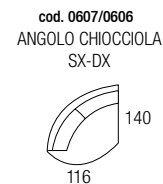
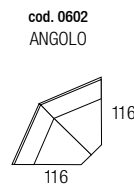
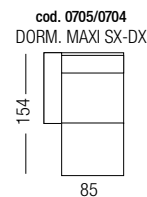
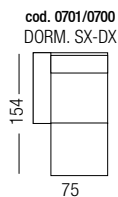
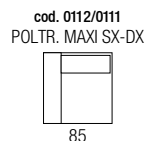
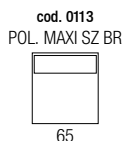
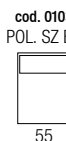
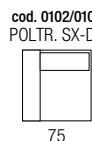
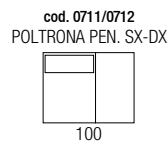
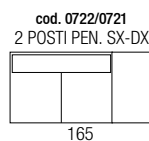
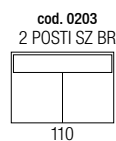
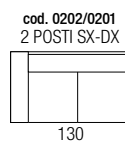
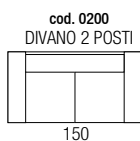
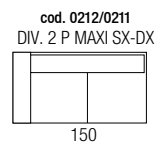
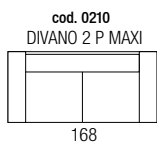
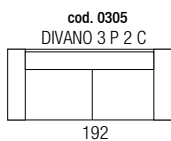
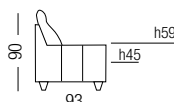
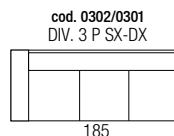
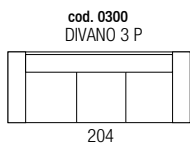

RIVESTIMENTO Pelle o microfibra non sfoderabile. Per le caratteristiche del rivestimento e la manutenzione vedere relative schede tecniche.

IMBOTTITURA Cuscini di seduta e braccioli in poliuretano espanso ecologico a densità differenziata. Cuscini di seduta di densità 30 kg/mc ricoperti con falda di dacron resinato da 100 gr/mq. Cuscini schienali realizzati in fibra di poliestere siliconata in fiocchi. Braccioli di densità 22 Kg/mc ricoperti da una termofalda di dacron autoestinguente da 350 gr/mq.

PIEDI In Legno massello di faggio evaporato tinto con vernici ecologiche ad acqua, nei colori: Noce brunito, Wengè. H 4 cm.

STRUTTURA Realizzata in legno abbinato a particelle di legno grezzo biodegradabile e pannelli di fibra di legno duro.

RETE due pieghe elettrosaldata (3 POSTI 150x186), (2 P MAX 120x186).

MATERASSO a molle, optional in poliuretano espanso (3 POSTI 130x180x12), (2 P MAX 100x180x12).

NOTE Nella versione relax il modello è realizzato con meccanismo combinato con movimento schienale poggiatesta. Disponibile sia manuale che elettrico con comando posizionato sul bracciolo laterale. L'elemento relax è sempre staccato da quello fisso e viene agganciato con apposito sistema a baionetta.

COVERING Leather, microfiber or fabric. Not removable.

PADDING Seat cushion 30kg/m3 covered with a dacron layer 100gr/m2

Armrest 22kg/m3 covered with dacron layer 350gr/m2

Backrest cushion: siliconed polyester fibre

FEET Beech feet color dark walnut, wengè. H4cm

FRAME Hard wood combined with plywood and particle board covered with a dacron layer.

BASE Electro-welded 2-ply (3 seater 150x186cm, 2 seater maxi 120x186cm)

MATTRESS Spring, polyurethane on demand (3 seater 130x180x12cm, 2 seater maxi 100x180x12cm)

NOTE Manual and electric recliner available.

RETEMENT Cuir, microfibre ou tissu non déhoussable.

REMBOURRAGE Coussins d'assise et accoudoirs: polyuréthane écologique à densité différenciée. Coussins d'assise: 30kg/m3 recouverts d'une couche de Dacron résiné 100gr/m2. Dossiers: flocons de mousse. Accoudoirs: densité 22kg/m3 recouverts d'une couche de dacron 350gr/m2.

PIED hêtre massif, vernis écologiques: noyer bruni ou Wengè. H 4cm.

STRUCTURE Bois recouvert d'une couche de dacron.

SOMMIER Électro-soudé à 2 plis (3 places 150x186, 2p.max 120x186).

MATELAS À ressorts, sur demande en polyuréthane (3 places 130x180x12, 2p.max 100x180x12).

NOTE Dans la version relax le modèle est réalisé avec un mécanisme combiné dossier/repose-pieds. Disponible en manuel ou électrique avec commande sur l'accoudoir. L'élément relax est toujours détaché du fixe et est attaché à ce dernier par un système spécifique à baionnette.

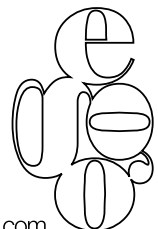
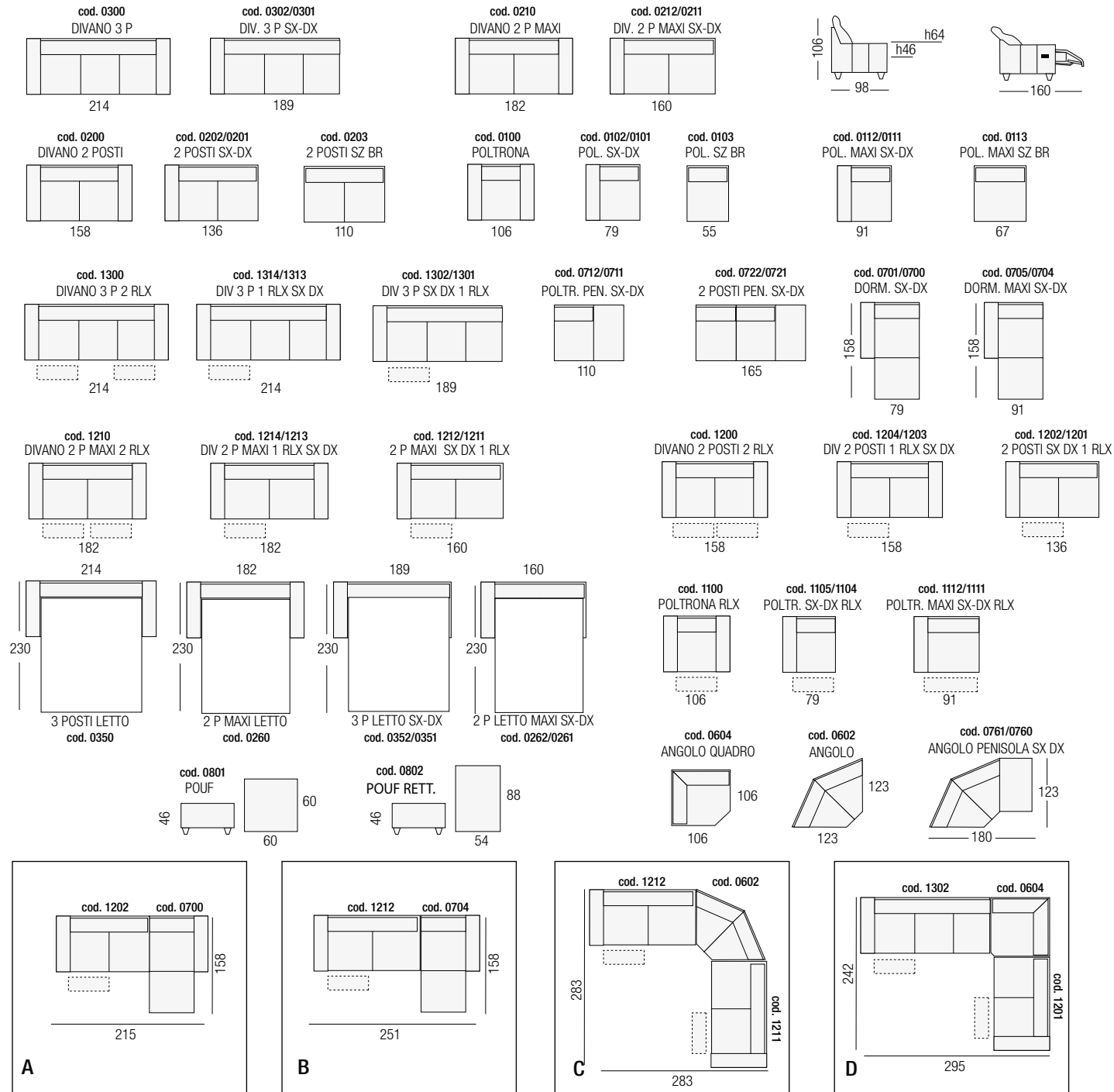

RIVESTIMENTO Pelle o microfibra non sfoderabile. Per le caratteristiche del rivestimento e la manutenzione vedere relative schede tecniche.

IMBOTTITURA Realizzate in poliuretano espanso ecologico a densità differenziate. Cuscini di seduta di densità 35 kg./mc. per lo strato inferiore e 30 kg./mc. per lo strato superiore. Cuscini schienali di densità 23 kg./mc. per la zona poggia reni e 30 kg./mc. per la zona schiena. Tampone bracciolo di densità 45 kg./mc. Cuscini di seduta e schienali sono ricoperti da una termofalda di dacron autoestinguente da 450 gr./mq.

PIEDI Piede in acciaio cromato h cm 13.

STRUTTURA Realizzata in legno abbinato a particelle di legno grezzo biodegradabile e pannelli di fibra di legno duro.

NOTE Il divano 3 posti maxi dx-sx e 3 posti dx-sx sono dotati di 3 cuscini schienale. Su richiesta il modello può essere dotato di poggiatesta.

COVERING Leather, microfiber or fabric. Not removable.

PADDING Backrest cushion: double density ecologic polyurethane foam. Bottom part: 30kg/m3. Upper part: 23kg/m3
Seat cushion: double density ecologic polyurethane foam. Bottom part: 34kg/m3 Upper part: 30kg/m3 Armrest: 45 kg/m3
Seat and backrest cushions covered with a dacron layer 450gr/m2

FEET Chromium-plated steel. Height: 13cm

FRAME Hard wood combined with plywood and particle board covered with a dacron layer.

NOTE 3 seater maxi sofa and lhf/rhf 3 seater sofa show three backrest loose cushions.

Headrest available on demand.
cushions.

Headrest cushion on demand.

REVÊTEMENT Cuir, microfibre ou tissu non déhoussable.

REMBOURRAGE Dossier en polyuréthane écologique avec double densité
Partie inférieure: 30 kg/m3. Partie supérieure :23kg/m3
Assise en polyuréthane écologique avec double densité
Partie inférieure: 35 kg/m3. Partie supérieure :30kg/m3
Accoudoirs densité 45kg/m3.

Coussins d'assise et dossiers recouverts d'une couche de dacron 450gr/m3.

PIEDS En acier chromé. Hauteur 13cm.

STRUCTURE En bois massif, multiplis et particules habillés d'une couche de dacron.

NOTE Le canapé 3 places maxi et le batard 3 places gauche/droit sont équipés avec trois coussins de dossiers.

Appuie-tête sur demande.

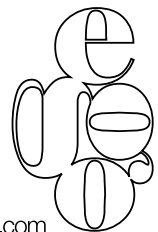
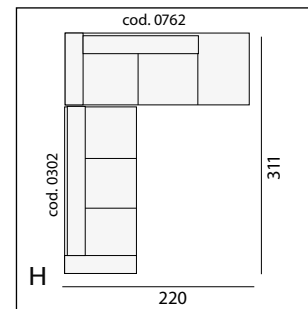
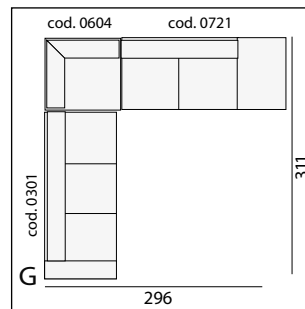
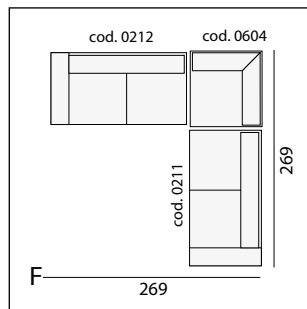
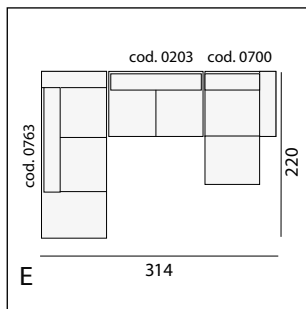
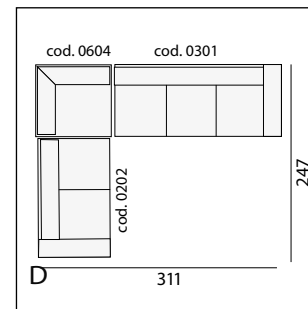
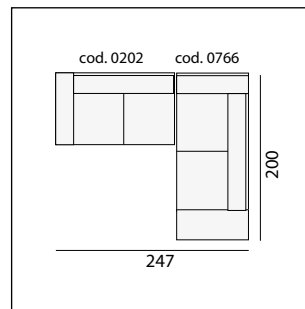
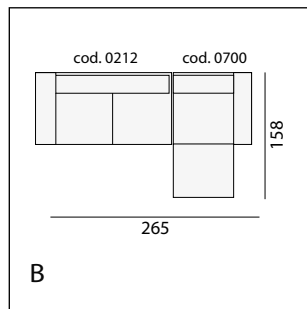
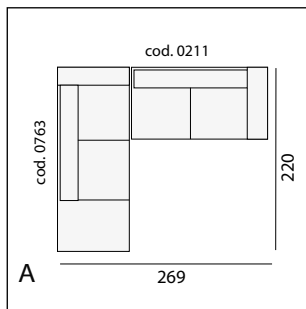
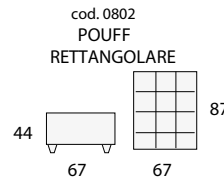
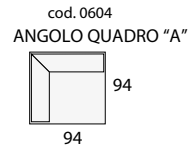
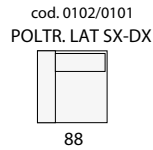
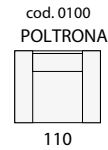
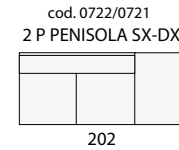
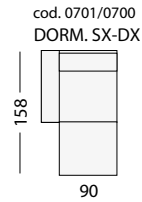
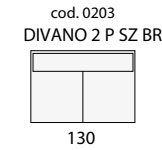
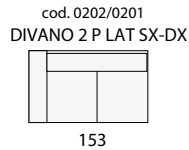
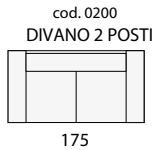
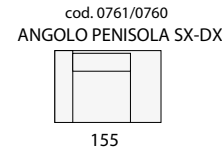
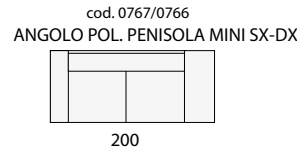
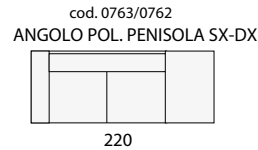
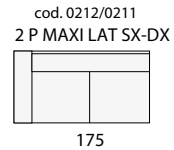
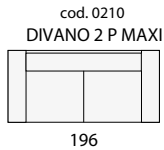
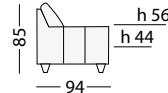
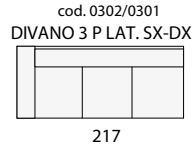
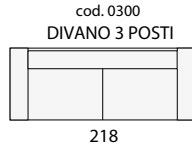
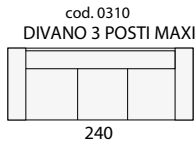

RIVESTIMENTO In pelle non sfoderabile. Per le caratteristiche del rivestimento e la manutenzione vedere relative schede tecniche. Il modello è realizzato con lavorazione "Capitoné".

IMBOTTITURA Schienali e braccioli realizzati in poliuretano espanso di densità 21 kg/mc ricoperti di dacron resinato autoestinguente. Cuscini di seduta removibili, realizzati con poliuretano espanso di densità 35 kg/mc, ricoperti con falda di dacron resinato autoestinguente da 350 gr/mq.

PIEDI In legno color noce brunito/wengé.

STRUTTURA Realizzata in legno abbinato a particelle di legno grezzo biodegradabile e pannelli di fibra di legno duro.

VERSIONE LETTO Rete 3 pieghe elettrosaldata; divano 3 posti cm 162x186; divano 2 posti cm 112x186; Materasso in poliuretano espanso; divano 3 posti cm 143 x 178 x h7; divano 2 posti cm 93 x 178 x h7.

COVERING Leather not removable. "Capitoné" finishing.

PADDING Ecologic polyurethane foam. Armrest and backrest cushion 21kg/m3 covered with a Dacron layer. Detachable seat cushion 35kg/m3. Seat cushion covered with dacron layer 350gr/m2.

FEET Wood. Colour available dark walnut and wenge

FRAME Hard wood combined with plywood and particle board covered with a dacron layer.

BED BASE Electro-welded 3-ply. 3 seater bed base 162x186cm – 2 seater bed base 112x186cm.

MATTRESS Polyurethane foam. 3 seater 143x178x7cm - 2 seater 93x178x7cm.

REVETEMENT Cuir, non déhoussable. Modèle « capitonné ».

REMBOURRAGE Dossier et accoudoir en polyuréthane écologique densité 21 kg/mc habillé d'un couche de dacron. Assise en polyuréthane écologique densité 35 kg/mc habillé d'un couche de dacron densité 350 gr/m2.

PIED En bois teinté noyer bruni ou wengé.

STRUCTURE En bois massif, multiplis et particules habillés d'un couche de dacron.

SOMMIER Électro-soudé à 3 plis. Sommier 3 places 162x186 - Sommier 2 places 112x186.

MATELAS En polyuréthane.

Matelas 3 places: 143x178x7 - Matelas 2 places: 93x178x7

cod. 0305

DIVANO 3 POSTI
(2 CUSCINI)

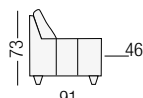
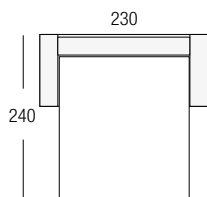
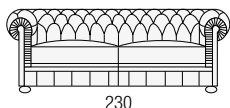

3 POSTI LETTO
cod. 0355

cod. 0304

DIVANO 3 POSTI
(3 CUSCINI)

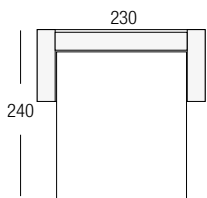
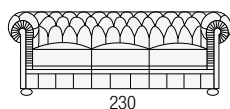

3 POSTI LETTO
cod. 0350

cod. 0210

DIV. 2 POSTI MAXI

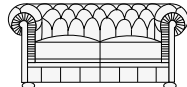

200

cod. 0200

DIVANO 2 POSTI

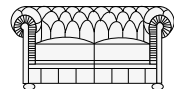

175

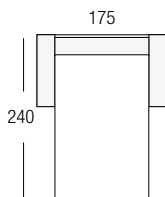

2 POSTI LETTO
cod. 0250

cod. 0100

POLTRONA



115

POLTRONCINA DIANA

cod. 0164

POLTRONCINA

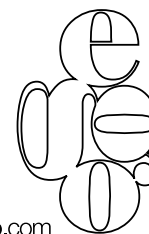
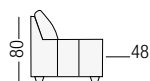

RIVESTIMENTO In pelle non sfoderabile. Per le caratteristiche del rivestimento e la manutenzione vedere relative schede tecniche. Il modello è realizzato con lavorazione "Capitoné".

IMBOTTITURA Schienali e braccioli realizzati in poliuretano espanso di densità 21 kg/mc ricoperti di dacron resinato autoestinguente. Cuscini di seduta removibili, realizzati con poliuretano espanso di densità 35 kg/mc, ricoperti con falda di dacron resinato autoestinguente da 350 gr/mq.

PIEDI In legno color noce brunito/wengè.

STRUTTURA Realizzata in legno abbinato a particelle di legno grezzo biodegradabile e pannelli di fibra di legno duro.

COVERING Leather not removable. "Capitoné" finishing.

PADDING Ecologic polyurethane foam. Armrest and backrest cushion 21kg/m3 covered with a Dacron layer. Detachable seat cushion 35kg/m3. Seat cushion covered with dacron layer 350gr/m2.

FEET Wood. Colour available dark walnut and wenge

FRAME Hard wood combined with plywood and particle board covered with a dacron layer.

BED BASE Electro-welded 3-ply. 3 seater bed base 162x186cm – 2 seater bed base 112x186cm.

REVETEMENT Cuir, non déhoussable. Modèle « capitonné ».

REMBOURRAGE Dossier et accoudoir en polyuréthane écologique densité 21 kg/mc habillé d'un couche de dacron. Assise en polyuréthane écologique densité 35 kg/mc habillé d'un couche de dacron densité 350 gr/m2.

PIED En bois teinté noyer bruni ou wengé.

STRUCTURE En bois massif, multiplis et particules habillés d'un couche de dacron.

SOMMIER Électro-soudé à 3 plis. Sommier 3 places 162x186 - Sommier 2 places 112x186.

cod. 0164

POLTRONCINA

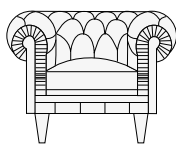

82

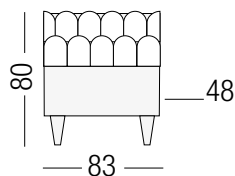

80

48

83

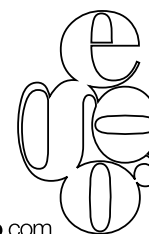

RIVESTIMENTO Pelle o microfibra non sfoderabile. Per le caratteristiche del rivestimento e la manutenzione vedere le schede tecniche.

IMBOTTITURA Cuscini di seduta, in poliuretano espanso ecologico di densità 30 Kg/mc ricoperti da una falda di dacron da 450 gr/mq. Cuscini di schienale e braccioli realizzati in fibra di poliestere siliconata in fiocchi.

PIEDI In Legno massello di faggio evaporato tinto con vernici ecologiche ad acqua, nei colori: Noce, Noce brunito, Wengè. H 3 cm.

STRUTTURA Realizzata in legno abbinato a particelle di legno grezzo biodegradabile e pannelli di fibra di legno duro.

RETE tre pieghe elettrosaldata (2 P MAX 142x187).

MATERASSO in poliuretano espanso (2 P MAX 180x122x6).

NOTE Nella versione letto il cuscino di seduta è removibile.

COVERING Leather, microfiber or fabric. Not removable.

PADDING Seat cushion: ecologic polyurethane foam 30kg/m3 covered with a dacron layer 450gr/m2.

Backrest cushion and armrest: siliconed polyester fibre

FEET Beech feet available with walnut, dark walnut or wengé finishing. Height: 3cm

FRAME Hard wood combined with plywood and particle board covered with a dacron layer

Bed base Electro-welded 3-ply: 2 seater maxi 142x187cm

Mattress Polyurethane foam: 2 seater maxi 180x122x6cm

NOTE Detachable seat cushions on sofa version.

REVÊTEMENT Cuir, microfibre ou tissu non déhoussable.

REMBOURRAGE Coussin d'assise en polyuréthane écologique 30kg/m3 habillé d'une couche de dacron 450 gr/m2.

Dossier et accoudoir: flocons de mousse

STRUCTURE En bois massif, multiplis et particules habillés d'une couche de dacron.

PIED hêtre massif teinté noyer, noyer bruni ou wengé. Hauteur 3cm.

Sommier Électro-soudé à 3 plis: 2places maxi 142cmx187cm

Matelas: En polyuréthane: 2places maxi 180cmx122cmx6cm

NOTE Coussin d'assise déhoussable pour la version canapé-lit

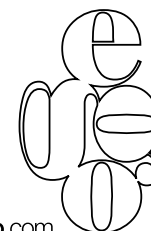
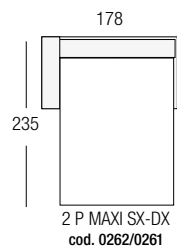
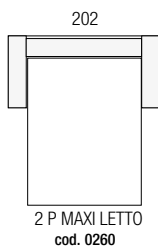
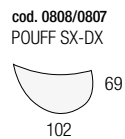
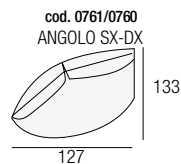
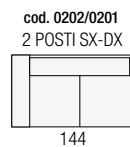
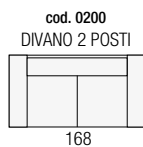
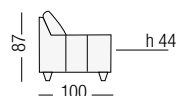
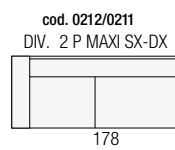
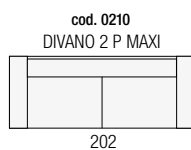

RIVESTIMENTO Pelle non sfoderabile, tessuto o microfibra sfoderabile. Per le caratteristiche del rivestimento e la manutenzione vedere relative schede tecniche.
IMBOTTITURA Sedute, schienali e braccioli realizzati in poliuretano espanso ecologico a densità differenziata, strato superiore di densità 35 kg/mc, strato inferiore di densità 40 Kg/mc. Tutte le parti in poliuretano sono ricoperte da una falda di dacron resinato da 100 gr/mq.

PIEDI Integrati nella struttura portante. I sedili girevoli sono dotati di ruote.

STRUTTURA Il telaio a vista è realizzato in tubolare d'acciaio inox, satinato, dotato di meccanismi a cricchetto sugli schienali ed è completato da basi realizzate in legno multistrato rivestito in laminato di supporto ai sedili.

NOTE Gli schienali sono dotati di meccanismo a cricchetto reclinabili a seconda del comfort desiderato. Entrambi i sedili ruotano di 90°, dando la possibilità di utilizzare le sedute come comode chaise-longue. La composizione è completata da un pouf corredato di ruote che riprende lo stesso design dei sedili e misura cm 101x101.

DESIGN Arch. Giulio Manzoni.

Il modello è coperto da brevetto internazionale.

COVERING Leather (not removable). Microfiber or fabric (removable).

PADDING Double density ecologic polyurethane foam. Bottom part 40 kg/m3 density and upper part 35 kg/m3 density. All covered with a 100 gr/m2 dacron layer.

FEET Satinized stainless steel base.

FRAME Satinized stainless steel.

NOTE Design: arch. Giulio Manzoni. Registered model.

Rotating seats equipped with wheels. Always equipped with adjustable backrest.

REVEITEMENT Cuir (revêtement fixe). Microfibre ou tissu (revêtement déhoussable)

REMBOURRAGE En polyuréthane écologique avec double densité habillé d'un couche de dacron densité 100 gr/m2. Partie inférieure 40kg/m3. Partie supérieure 35kg/m3.

PIED Base en acier satiné.

STRUCTURE En acier satiné.

NOTE Design: arch. Giulio Manzoni. Modèle déposé

Assise tournante équipé avec roues Dossier équipé avec mécanisme réglable.

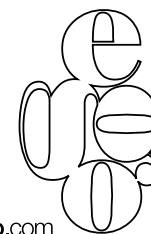
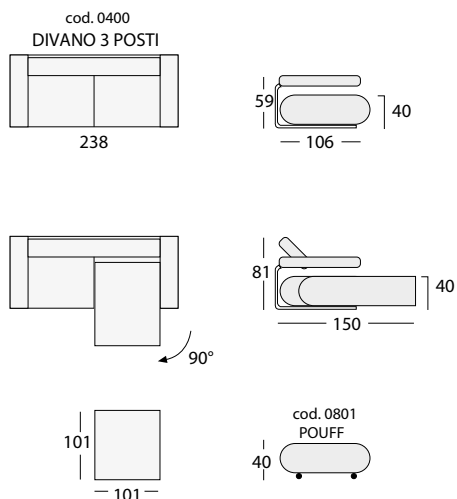

RIVESTIMENTO Pelle o microfibra non sfoderabile. Per le caratteristiche del rivestimento e la manutenzione vedere relative schede tecniche.

IMBOTTITURA Realizzate in poliuretano espanso ecologico a densità differenziate. Cuscini di seduta con densità 35 kg/mc per lo strato inferiore e 30 kg/mc per lo strato superiore. Cuscini schienali con densità 23 kg/mc per la zona poggia reni e 30 kg/mc per la zona schiena. Tampone bracciolo di densità 45 kg/mc. Cuscini di seduta e schienali sono ricoperti da una termofalda di dacron autoestinguente da 450 gr/mq.

PIEDI Il modello è corredato di una base tubolare d'acciaio cromato con piedi integrati h cm 10.

STRUTTURA Realizzata in legno abbinato a particelle di legno grezzo biodegradabile e pannelli di fibra di legno duro.

NOTE Il divano 3 posti maxi dx-sx e 3 posti dx-sx sono dotati di 3 cuscini schienale. Su richiesta il modello può essere dotato di poggiatesta.

COVERING Leather, microfiber or fabric. Not removable.

PADDING Backrest cushion: double density ecologic polyurethane foam. Bottom part: 30kg/m3. Upper part: 23kg/m3

Seat cushion: double density ecologic polyurethane foam. Bottom part: 34kg/m3 Upper part: 30kg/m3 Armrest: 45 kg/m3

Seat and backrest cushions covered with a dacron layer 450gr/m2

FEET Chromium-plated steel base. Height: 10cm

FRAME Hard wood combined with plywood and particle board covered with a dacron layer.

NOTE 3 seater maxi sofa and lhf/rhf 3 seater sofa show three backrest loose cushions.

Headrest available on demand.

cushions.

Headrest cushion on demand.

REVÊTEMENT Cuir, microfibre ou tissu non déhoussable.

REMBOURRAGE Dossier en polyuréthane écologique avec double densité

Partie inférieure: 30 kg/m3. Partie supérieure :23kg/m3

Assise en polyuréthane écologique avec double densité

Partie inférieure: 35 kg/m3. Partie supérieure :30kg/m3

Accoudoirs densité 45kg/m3.

Coussins d'assise et dossiers recouverts d'une couche de dacron 450gr/m3.

PIEDS Base en acier chromé. Hauteur 10cm.

STRUCTURE En bois massif, multiplis et particules habillés d'une couche de dacron.

NOTE Le canapé 3 places maxi et le batard 3 places gauche/droit sont équipés avec trois coussins de dossiers.

Appuie-tête sur demande.

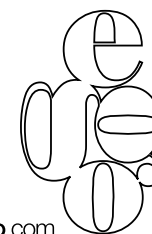
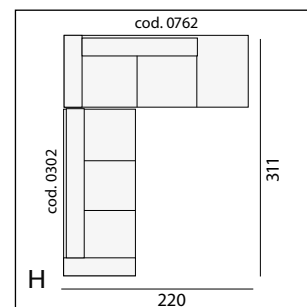
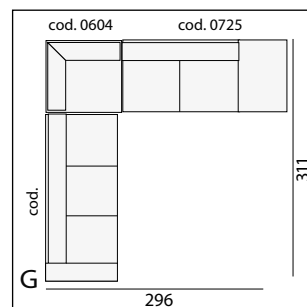
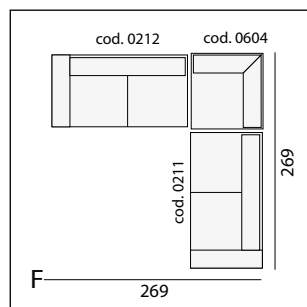
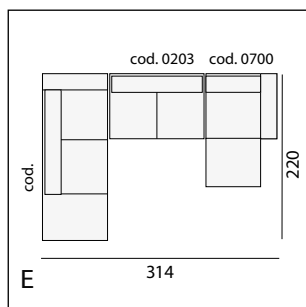
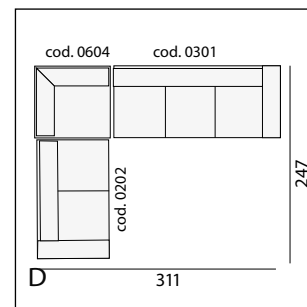
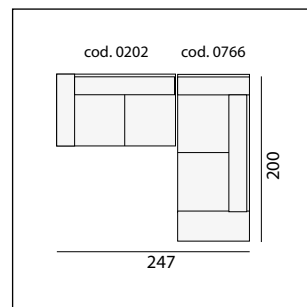
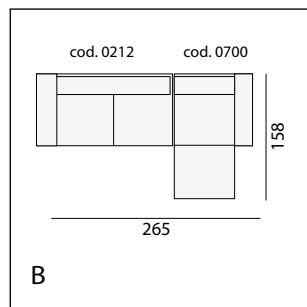
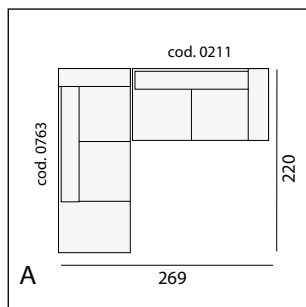
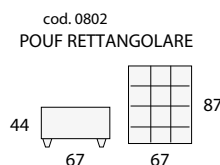
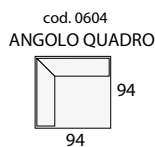
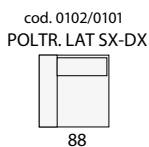
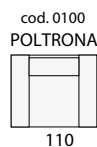
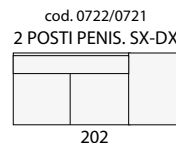
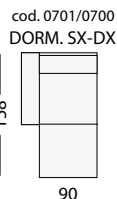
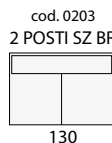
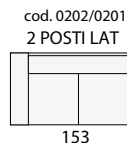
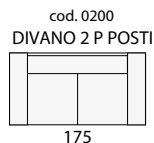
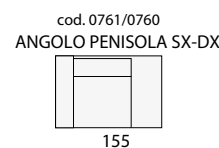
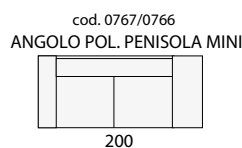
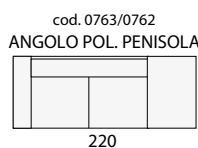
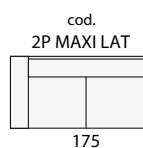
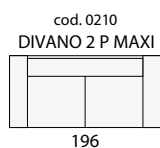
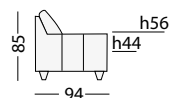
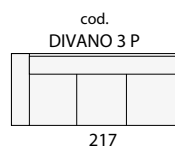
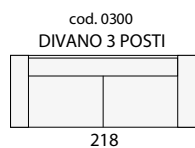
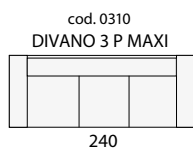

RIVESTIMENTO In tessuto e microfibra sfoderabile. Per le caratteristiche del rivestimento e la manutenzione vedere relative schede tecniche.

IMBOTTITURA Cuscino schienale realizzato in poliuretano espanso di densità 25 kg/mc, ricoperto con falda di dacron resinato autoestinguente da 350 gr/mq.

PIEDI In abs integrati con la struttura.

STRUTTURA In acciaio tubolare finito con vernici a polvere epossidiche.

VERSIONE LETTO Meccanismo rete elettrosaldata 3 pieghe:

2 posti cm 120 x 193; Poltrona cm 73 x 193;

Materasso in poliuretano espanso: 2 posti cm 120 x 193 x 10; Poltrona cm 73 x 193 x 10;

COVERING Microfiber or fabric removable.

PADDING Backrest cushion 25kg/m3 polyurethane foam covered with a dacron layer 350gr/m2

FEET Tubular steel.

BED BASE Electro-welded 3-ply - 2 seater 120x193cm – armchair 73x193cm

MATTRESS Polyurethane foam mattress - 2 seater 120x193x10cm - armchair 73x193x10cm

REVÊTEMENT Microfibre ou tissu déhoussable.

REMBOURRAGE Dossiers en polyuréthane densité 25kg/m3 recouvert d'une couche de dacron 350gr/m2

PIEDS En acier tubulaire

SOMMIER Électro-soudé à 3 plis - 2 places 120x193 - fauteuil 73x193

MATELAS En polyuréthane - 2 places: 120x193x10 - fauteuil: 73x193x10

cod. 0150
POLTRONA LETTO

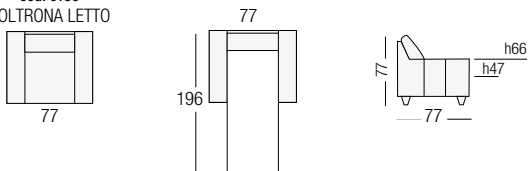

cod. 0250
2 POSTI LETTO

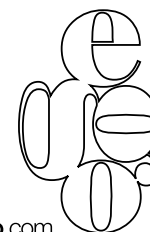
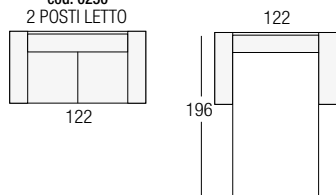

RIVESTIMENTO Pelle, tessuto o microfibra. In tessuto o microfibra, su richiesta, il modello è disponibile anche in versione sfoderabile. Si prega di fare riferimento al listino prezzi appropriato. Per le caratteristiche del rivestimento e della manutenzione vedere relative schede tecniche.

IMBOTTITURA Realizzate in poliuretano espanso a densità differenziate. Cuscino di seduta di densità 40 kg/mc per lo strato inferiore e 35 kg/mc per lo strato superiore. Schienali di densità 30 kg/mc. Le imbottiture sono rivestite da una termo falda di dacron da 200 gr/mq.

PIEDI Versione fissa: in legno massello di faggio evaporato tinto con vernici ecologiche all'acqua, nei colori noce, noce brunito o wengè.

Versione girevole: base circolare realizzata in tubolare d'acciaio verniciato, ruotante a 360°.

STRUTTURA Realizzata in legno abbinato a particelle di legno grezzo biodegradabile e pannelli di fibra di legno duro.

COVERING: Leather, fabric or Microfiber. In fabric or microfiber, upon request, the model is also available with fully removable covers. Please refer to the appropriate price list. Not removable. Please check covering details for care instructions.

PADDING: Varying density ecologic polyurethane foam covered with a double density dacron layer 200 gr/m2

Seat cushion: Bottom part: 40 kg/m3. Upper part 35kg/m3.

Backrest cushion: 30kg/m3.

FEET Fix version: beech feet available with walnut, dark walnut or wengé finishing
Swivel version: tubular steel round base

FRAME Hard wood combined with plywood and particle board covered with a dacron layer.

REVÊTEMENT Cuir, tissu ou microfibre. En tissu ou microfibre, sur demande, le modèle est aussi disponible avec revêtement totalement déhoussable. Merci de vous référer au tarif correspondant. Pour les caractéristique du revêtement aussi bien que pour l'entretien veuillez consulter les fiches technique appropriées.

REMBOURRAGE Coussins d'assise, dossiers et accoudoirs en polyuréthane à densité différencié et recouverts d'une double couche de Dacron 200 gr/m2
Coussins d'assise : densité 40 kg/m3 pour la partie inférieure et 35 kg/m3 pour la partie supérieure.

Dossier: densité 30 kg/m3

PIEDS Version fixe : hêtre massif. Finition disponible: noyer, noyer bruni ou wengé.

Version tournante : base circulaire en acier tubulaire

STRUCTURE En bois massif, multiplis et particules habillés d'un couche de dacron.

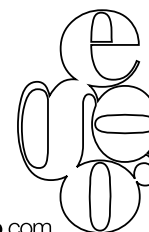
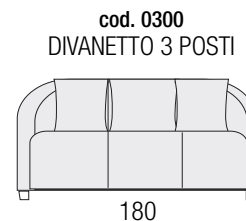
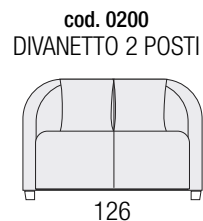
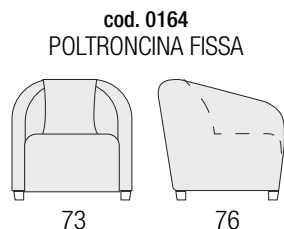
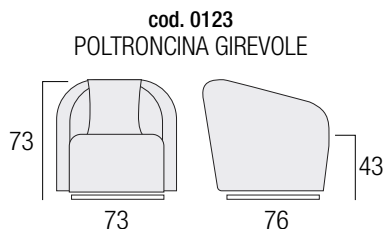

RIVESTIMENTO In pelle o microfibra non sfoderabile. Per le caratteristiche del rivestimento e la manutenzione vedere relative schede tecniche.

IMBOTTITURA Schienali con movimento manuale di apertura/chiusura e poggiatesta regolabili in poliuretano espanso di densità 25 kg/mc ricoperti con una falda di dacron resinato autoestinguente da 200 gr/mq. Cuscini di seduta realizzati in poliuretano espanso con densità 30kg/mc ricoperti con termofalda di dacron resinato autoestinguente da 450 gr/mq.

PIEDI In alluminio con parte terminale in plexiglass trasparente.

Altezza totale cm 12.

STRUTTURA Realizzata in legno abbinato a particelle di legno grezzo biodegradabile e pannelli di fibra di legno duro.

NOTE Il modello è dotato di meccanismo manuale con pistoni a gas che permette di variare la posizione dello schienale. Tale meccanismo è assente nelle spalliere dell'elemento ad angolo ed è opzionale nelle spalliere dell'elemento angolo poltrona penisola. Su tutti gli elementi penisola inoltre è possibile ottenere su richiesta la spalliera terminale. Tutte le versioni del modello sono corredate di una base avente funzione puramente estetica, realizzata in tubolare d'acciaio cromato.

COVERING Leather, microfiber or fabric. Not removable.

PADDING Backrest and headrest: 25Kg/m3 density ecologic polyurethane foam covered with a 200 gr/m2 dacron layer. Seat cushion: 30Kg/m3 density ecologic polyurethane foam covered with a 450 gr/m2 dacron layer.

FEET Plexiglas and aluminium feet combined with chromium-plated steel base

FRAME Hard wood combined with plywood and particle board covered with a dacron layer.

NOTE Backrest always equipped with gas adjustable headrest

Corner single unit (code 0602) not available with adjustable headrest.

Adjustable headrest upon request on the corner unit "lhf/rhf va one seater chaise" (code 0763/0762).

REVETEMENT Cuir, microfibra ou tissu. Les revêtements sont fixes.

REMBOURRAGE Dossier et appui-tête en polyuréthane écologique densité 25kg/m3 habillé d'une couche de dacron densité 200 gr/m2. Assise en polyuréthane écologique densité 30kg/m3 habillé d'une couche de dacron densité 450 gr/m2.

PIED Aluminium et plexiglas avec une base en acier chromé.

STRUCTURE En bois massif, multiplis et particules habillés d'une couche de dacron.

NOTE Dossier équipé avec mécanisme à gaz réglable. Version angle (code 0602)

pas disponible avec mécanisme. Version angle méridienne (code 0763/0762)

équipé avec mécanisme sur demande.

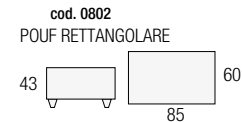
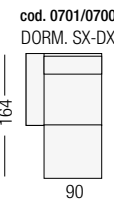
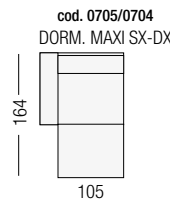
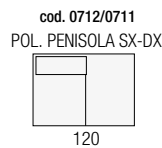
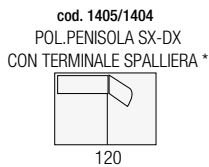
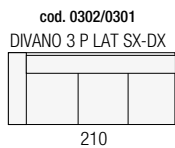
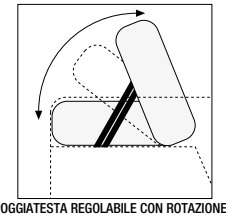
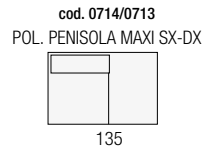
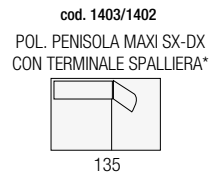
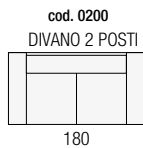
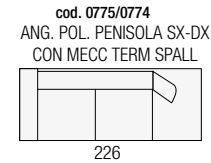
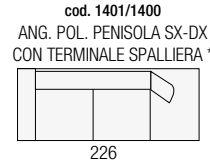
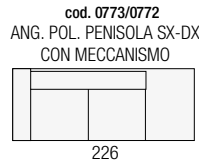
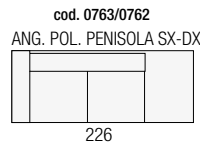
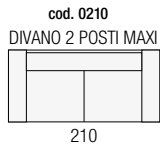

* TERMINALE SPALLIERA SU RICHIESTA

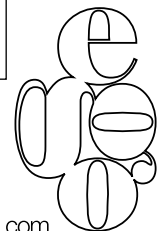
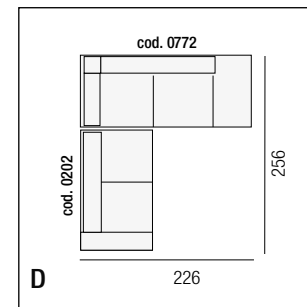
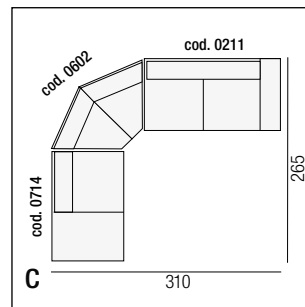
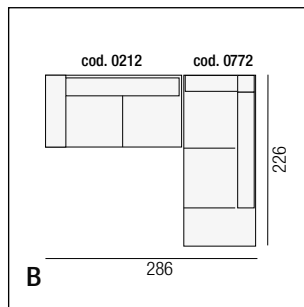
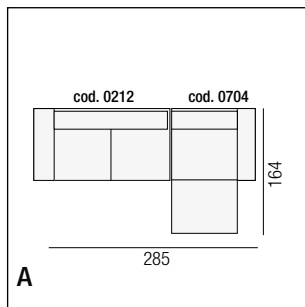
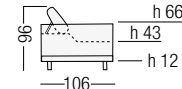
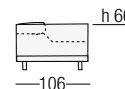
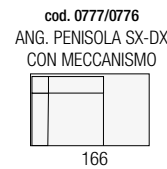
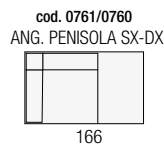
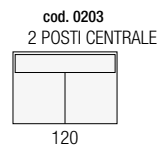
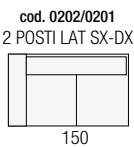
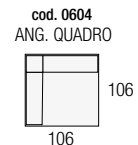
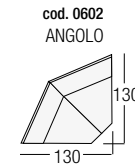
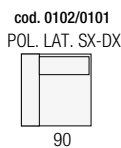
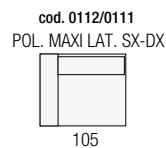
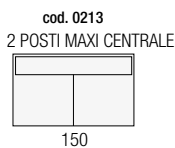
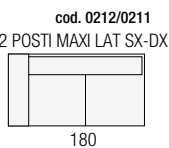

RIVESTIMENTO Pelle o microfibra non sfoderabile. Per le caratteristiche del rivestimento e la manutenzione vedere relative schede tecniche.

IMBOTTITURA Cuscini schienali realizzati in poliuretano espanso a doppia densità; parte superiore (schienale) di densità 18 Kg/mc, parte inferiore (poggiareni) di densità 21 Kg/mc. Cuscino di seduta realizzato in poliuretano espanso di densità 35 kg/mc con uno strato superiore di densità 30 Kg/mc. Schienali, poggiatesta e cuscini di seduta sono ricoperti con termofalda di dacron resinato autoestinguente da 450 gr/mq.

PIEDI La poltrona ed il pouf poggiano su una base realizzata in acciaio satinato. La base della poltrona è girevole e misura cm 14 in altezza e cm 58 di diametro. La base del pouf è fissa e misura cm 12 di altezza e cm 45 di diametro.

STRUTTURA Realizzata in legno abbinato a particelle di legno grezzo biodegradabile e pannelli di fibra di legno duro.

COVERING Leather, microfiber or fabric. Not removable.

PADDING Backrest cushion: double density ecologic polyurethane foam. Bottom part 21 kg/m3 and upper part 18 kg/m3.

Seat cushion: 30 kg/m3 ecologic polyurethane foam. All covered with a 450 gr/m2 dacron layer.

FEET Satinized stainless steel base. Chair equipped with swivel base, footstool equipped with fix base.

FRAME Hard wood combined with plywood and particle board covered with a dacron layer.

REVELEMENT Cuir, microfibre ou tissu. Les revêtements sont fixes.

REMBOURRAGE Dossier en polyuréthane écologique avec double densité. Partie inférieure 21kg/m3. Partie supérieure 18kg/m3.

Assise en polyuréthane écologique densité 30kg/m3.

Assise et dossier habillé d'un couche de dacron densité 450 gr/m2.

STRUCTURE En bois massif, multiplis et particules habillés d'un couche de dacron.

PIED Base en acier satiné (pivotante pour le fauteuil, fixe pour le pouf).

cod. 0125
POLTRONA
GIREVOLE

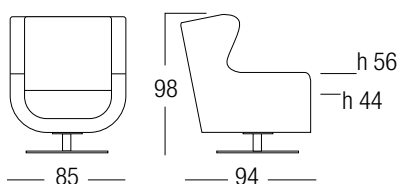

cod. 0123
POLTRONCINA
GIREVOLE

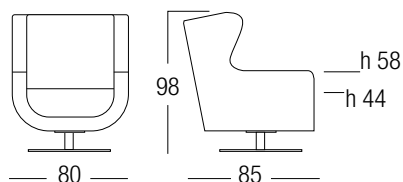

cod. 0802
POUF

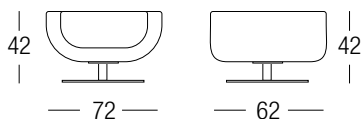

cod. 0802
POUF

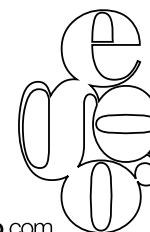
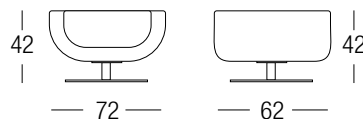

RIVESTIMENTO Pelle o microfibra, non sfoderabile. Per le caratteristiche del rivestimento e la manutenzione, vedere relative schede tecniche.

IMBOTTITURA Cuscino di seduta realizzato in poliuretano espanso di densità 30 kg/mc ricoperto da una falda di dacron da 450 gr/mq. Schienali realizzati in poliuretano espanso di densità 18 kg/mc ricoperti da una falda di dacron da 450 gr/mq. Braccioli realizzati in poliuretano espanso di densità 21 kg/mc ricoperto da falde di dacron da 100 e da 200 gr/mq. Poggiatesta realizzato in poliuretano espanso a densità differenziata da 18 kg/mc e 30 kg/mc, ricoperto da una falda di dacron da 450 gr/mq. Imbottiture di completamento in poliuretano espanso di densità 21 kg/mc.

PIEDI In acciaio cromato, h 8 cm.

STRUTTURA Realizzata in legno abbinato a particelle di legno grezzo biodegradabile e pannelli di fibra di legno duro.

NOTE Gli schienali sono dotati di meccanismi manuali con cricchetti a scatti, reclinabili a seconda del comfort desiderato.

COVERING Leather, microfiber or fabric. Not removable.

PADDING Ecologic polyurethane foam.

Seat cushion: 30kg/m3 density and backrest cushion 18kg/m3 density covered with a dacron layer 450gr/m2. Armrest cushion: 21 kg/m3 density covered with a dacron layer 100gr/m2 and 200gr/m2. Headrest: double density ecologic polyurethane foam 30 kg/m3 and 18 kg/m3 covered with a dacron layer 450gr/m2.

FEET Chromium-plated steel. Height: 8 cm.

FRAME Hard wood combined with plywood and particle board covered with a Dacron layer.

NOTE Adjustable headrest.

REVETEMENT Cuir, microfibre ou tissu non déhoussable.

REMBOURRAGE Coussins d'assise: polyuréthane densité 30 kg/m3 recouverts d'une couche de Dacron de 450 gr/m2. Dossiers: polyuréthane densité 18 kg/m3 recouverts d'une couche de Dacron de 450 gr/m2. Accoudoirs: polyuréthane densité 21 kg/m3 recouverts d'une double couche de Dacron 100 et 200 gr/m2. Appuis-tête: polyuréthane à densité différenciée de 18 et 30 kg/m3, recouvert d'une couche de Dacron 450gr/m2.

Rembourrage de complément en polyuréthane 21kg/m3.

PIED Acier chromé, h 8 cm.

STRUCTURE En bois massif, multiplis et particules habillés d'un couche de dacron.

NOTE Les dossiers sont équipés d'un mécanisme manuel au niveau des appuie-tête, réclinables selon le confort désiré.

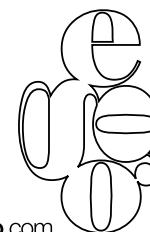
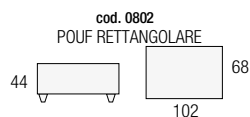
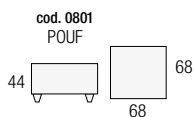
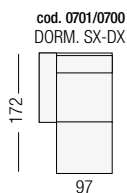
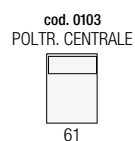
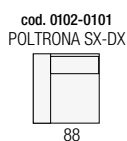
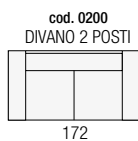
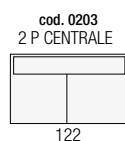
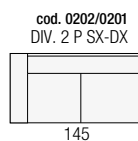
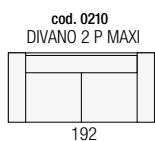
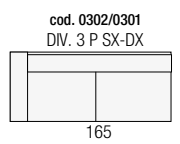
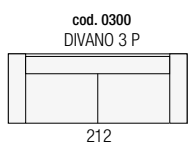
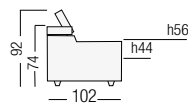
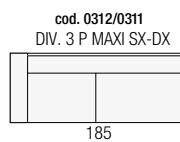
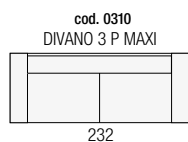

RIVESTIMENTO Pelle o microfibra non sfoderabile. Per le caratteristiche del rivestimento e della manutenzione vedere relative schede tecniche.

IMBOTTITURA Cuscini di seduta e braccioli sono realizzati in poliuretano espanso ecologico a densità differenziate. Cuscini di seduta: densità 30 kg/mc ricoperti con una termofalda di dacron autoestinguente da 450 gr/mq. Braccioli: densità 23 kg/mc ricoperti con una termofalda di dacron autoestinguente da 350 gr/mq. Cuscini schienali: realizzati in fibra poliestere siliconata in fiocchi. Imbottiture di completamento: densità 21 kg/mc.

PIEDI In legno massello di faggio evaporato tinto con vernici ecologiche ad acqua, nei colori: noce brunito, wengè, H: cm 4

STRUTTURA Realizzata in legno abbinato a particelle di legno grezzo biodegradabile e pannelli di fibra di legno duro.

NOTE Nella versione relax il modello è realizzato con meccanismo combinato con movimento schienale poggiatesta. Disponibile sia manuale che elettrico con comando posizionato sul bracciolo laterale. L'elemento relax è sempre staccato da quello fisso e viene agganciato con apposito sistema a baionetta.

COVERING Leather, microfiber or fabric. Not removable.

PADDING Ecologic polyurethane foam.

Seat cushion: 30kg/m³ covered with a dacron layer 450gr/m²

Armrest cushion: 23kg/m³ covered with dacron layer 350gr/m²

Backrest cushion: siliconed polyester fibre

FEET Beech feet. Available finishing: dark walnut and wengè. Height: 4cm

FRAME Hard wood combined with plywood and particle board covered with a dacron layer.

NOTE Manual and electric recliner available

REVETEMENT Cuir, microfibra ou tissu non déhoussable

REMBOURRAGE Coussins d'assise et accoudoirs : polyuréthane écologique à densité différenciée. Coussins d'assise : 30 kg/m³ recouverts d'une couche de dacron résiné 450 gr/m². Dossier : flocons de mousse. Accoudoirs : densité 23 kg/m³ recouverts d'une couche de dacron 350 gr/m²

PIED Hêtre massif, vernis écologiques : finition disponible noyer bruni ou wengè. Hauteur : 4cm

STRUCTURE En bois habillé d'un couche de dacron

NOTE Dans la version relax le modèle est réalisé avec un mécanisme combiné dossier/repose-pieds. Disponible en manuel ou électrique avec commande sur l'accoudoir. L'élément relax est toujours détaché du fixe et attaché à ce dernier par un système spécifique à baïonnette.

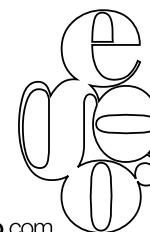
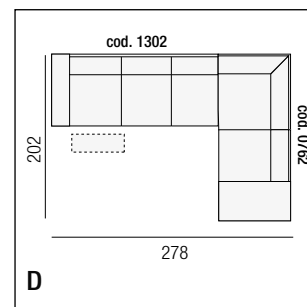
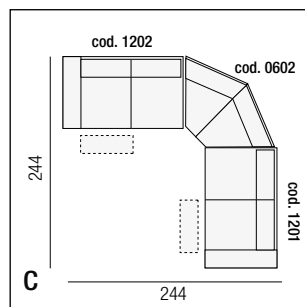
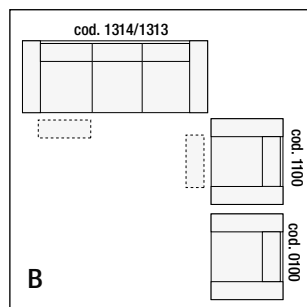
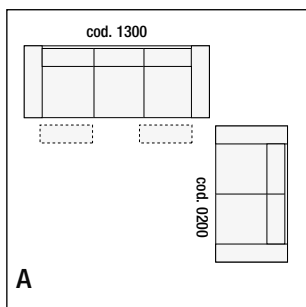
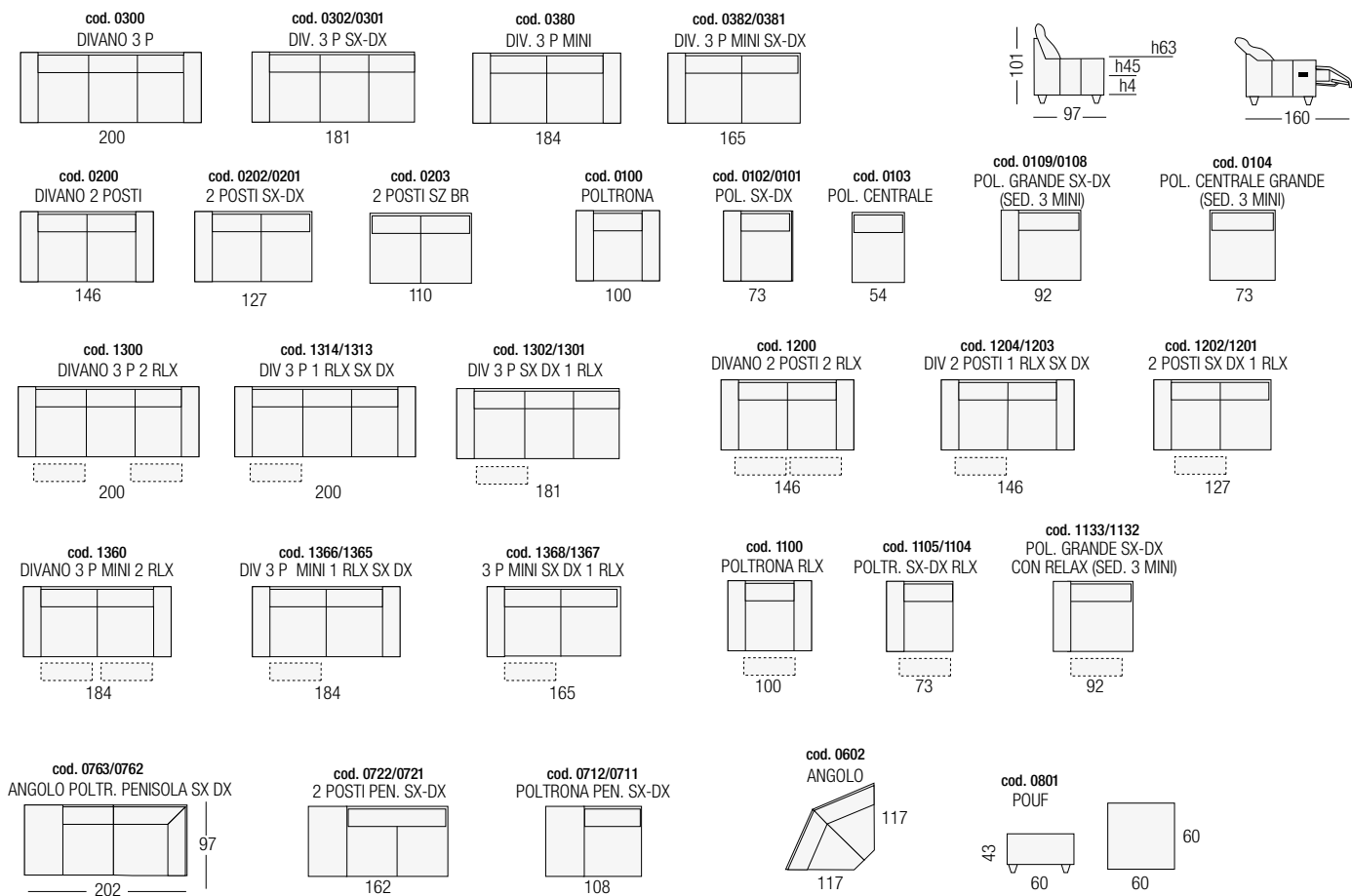

RIVESTIMENTO Pelle o microfibra non sfoderabile. Per le caratteristiche del rivestimento e della manutenzione vedere relative schede tecniche.

IMBOTTITURA Cuscini di seduta e braccioli sono realizzati in poliuretano espanso ecologico a densità differenziate. Cuscini di seduta: densità 30 kg/mc ricoperti con una termofalda di dacron autoestinguente da 450 gr/mq. Braccioli: densità 23 kg/mc ricoperti con una termofalda di dacron autoestinguente da 350 gr/mq. Cuscini schienali: realizzati in fibra poliestere siliconata in fiocchi. Imbottiture di completamento: densità 21 kg/mc.

PIEDI In legno massello di faggio evaporato tinto con vernici ecologiche ad acqua, nei colori: noce brunito, wengè, H: cm 4

STRUTTURA Realizzata in legno abbinato a particelle di legno grezzo biodegradabile e pannelli di fibra di legno duro.

NOTE Nella versione relax il modello è realizzato con meccanismo combinato con movimento schienale poggiatesta. Disponibile sia manuale che elettrico con comando posizionato sul bracciolo laterale. L'elemento relax è sempre staccato da quello fisso e viene agganciato con apposito sistema a baionetta.

COVERING Leather, microfiber or fabric. Not removable.

PADDING Ecologic polyurethane foam.

Seat cushion: 30kg/m³ covered with a dacron layer 450gr/m²

Armrest cushion: 23kg/m³ covered with dacron layer 350gr/m²

Backrest cushion: siliconed polyester fibre

FEET Beech feet. Available finishing: dark walnut and wengè. Height: 4cm

FRAME Hard wood combined with plywood and particle board covered with a dacron layer.

NOTE Manual and electric recliner available

REVETEMENT Cuir, microfibre ou tissu non déhoussable

REMBOURRAGE Coussins d'assise et accoudoirs : polyuréthane écologique à densité différenciée. Coussins d'assise : 30 kg/m³ recouverts d'une couche de dacron résiné 450 gr/m². Dossier : flocons de mousse. Accoudoirs : densité 23 kg/m³ recouverts d'une couche de dacron 350 gr/m²

PIED Hêtre massif, vernis écologiques : finition disponible noyer bruni ou wengè. Hauteur : 4cm

STRUCTURE En bois habillé d'un couche de dacron

NOTE Dans la version relax le modèle est réalisé avec un mécanisme combiné dossier/repose-pieds. Disponible en manuel ou électrique avec commande sur l'accoudoir. L'élément relax est toujours détaché du fixe et attaché à ce dernier par un système spécifique à baïonnette.

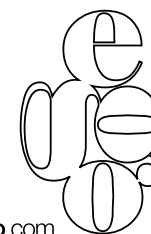
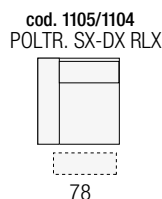
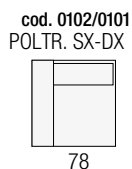
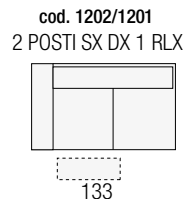
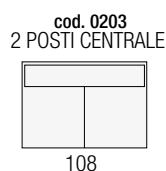
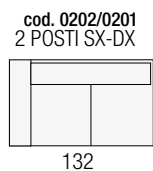
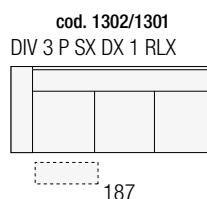
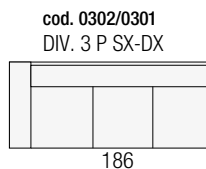
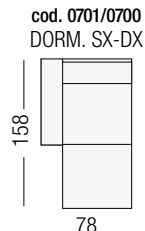
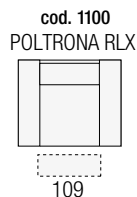
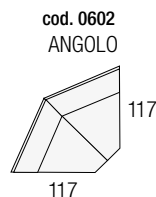
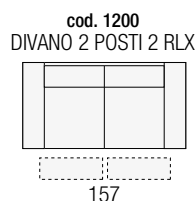
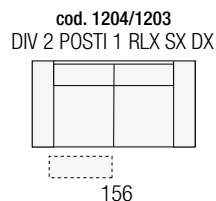
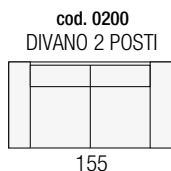
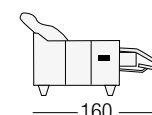
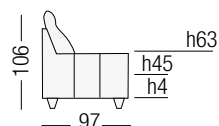
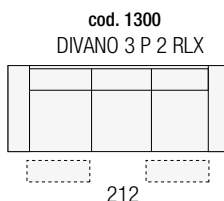
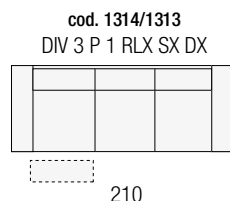
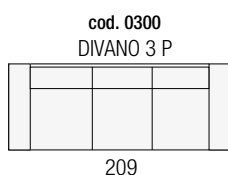

RIVESTIMENTO Pelle o microfibra non sfoderabile. Per le caratteristiche del rivestimento e della manutenzione vedere relative schede tecniche.

IMBOTTITURA Cuscini di seduta, braccioli e schienali sono realizzati in poliuretano espanso a densità differenziate. Tutte le parti sopraelencate sono ricoperte da una termofalda di dacron autoestinguente. Cuscini di seduta: densità 35 kg/mc. Termofalda da 450 gr/mq. Braccioli: densità 30 kg/mc. Termofalda da 450 gr/mq. Schienali: densità 30 kg/mc. Termofalda da 450 gr/mq. Imbottiture di completamento: densità 30 kg/mc.

PIEDI Slitta in acciaio lucidato, H alla base del divano: cm 14

STRUTTURA Realizzata in legno abbinato a particelle di legno grezzo biodegradabile e pannelli di fibra di legno duro.

NOTE Gli schienali del modello sono dotati di un meccanismo manuale che permette facilmente di spostarli in posizione arretrata ottenendo una maggiore profondità di seduta ed offrendo la possibilità di distendere le gambe per un comfort superiore. Tale meccanismo non è presente nella parte angolare dell'elemento angolo poltrona penisola.

COVERING Leather, microfiber or fabric. Not removable.

PADDING Seat cushion, armrest and backrest: polyurethane foam covered with a Dacron layer. Seat cushion 35kg/m3. Dacron layer: 450 gr/m2

Armrest and backrest: 30 kg/m3. Dacron layer: 450 gr/m2

FEET Polished stainless steel base. Height 14 cm

FRAME Hard wood combined with plywood and particle board covered with a Dacron layer.

NOTE Model equipped with a manual mechanism to adjust each sofa seat depth into a real chaiselongue.

Mechanism not available on corner seat of 0763/0762 unit.

STRUCTURE En bois massif, multiplis et particules habillés d'une couche de dacron.

REMBOURRAGE Coussins d'assise, accoudoirs et dossiers réalisés en polyuréthane écologique à densité différenciée, recouvert avec une couche de dacron. Assise: 35 Kg/m3. Couche de dacron 450 gr/m2. Accoudoirs: 30 Kg/m3. Dacron 450 gr/m2. Dossiers: 30 Kg/m3. Dacron 450 gr/m2

Rembourrage de completamento: 30 Kg/m3

RETEVEMENT Cuir ou microfibre non déhoussable.

PIEDS Base en acier brillant, hauteur 14 cm

NOTE Les dossiers sont équipés d'un mécanisme manuel permettant de les déplacer facilement en position arriérée, obtenant une profondeur d'assise plus importante et offrant la possibilité d'étendre les jambes pour un confort supérieur. Ce mécanisme n'est pas présent sur l'angle de l'élément batard 1 place angle peninsula.

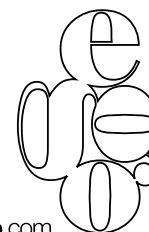
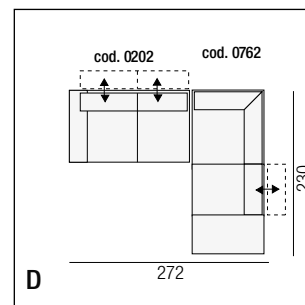
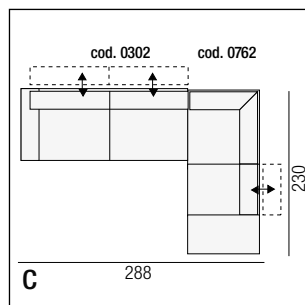
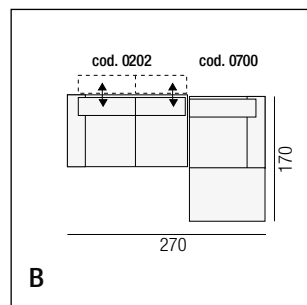
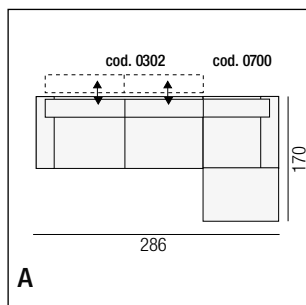
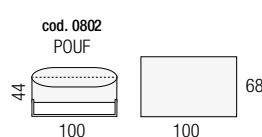
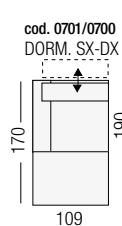
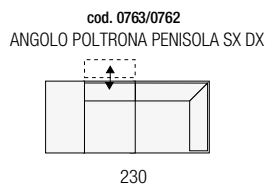
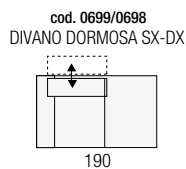
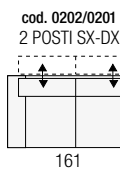
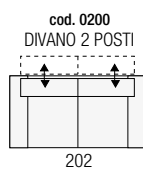
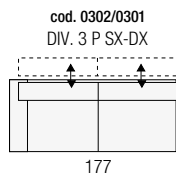
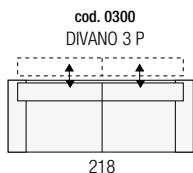
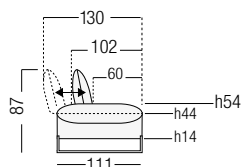
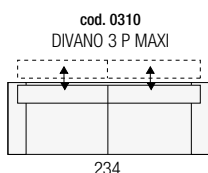

ROXANNE 2 SUPER

Rev. 05/2012

RIVESTIMENTO Pelle o microfibra non sfoderabile. Per le caratteristiche del rivestimento e della manutenzione vedere relative schede tecniche.

IMBOTTITURA Cuscini di seduta, braccioli e schienali sono realizzati in poliuretano espanso a densità differenziate. Tutte le parti sopraelencate sono ricoperte da una termofalda di dacron autoestinguente. Cuscini di seduta: densità 35 kg/mc. Termofalda da 450 gr/mq. Braccioli: densità 30 kg/mc. Termofalda da 450 gr/mq. Schienali: densità 30 kg/mc. Termofalda da 450 gr/mq. Imbottiture di completamento: densità 30 kg/mc.

PIEDI Slitta in acciaio lucidato, H alla base del divano: cm 14

STRUTTURA Realizzata in legno abbinato a particelle di legno grezzo biodegradabile e pannelli di fibra di legno duro.

NOTE Gli schienali del modello sono dotati di un meccanismo manuale che permette facilmente di spostarli in posizione arretrata ottenendo una maggiore profondità di seduta ed offrendo la possibilità di distendere le gambe per un comfort superiore. Tale meccanismo non è presente nella parte angolare dell'elemento angolo poltrona penisola.

COVERING Leather, microfiber or fabric. Not removable.

PADDING Seat cushion, armrest and backrest: polyurethane foam covered with a Dacron layer. Seat cushion 35kg/m3. Dacron layer: 450 gr/m2

Armrest and backrest: 30 kg/m3. Dacron layer: 450 gr/m2

FEET Polished stainless steel base. Height 14 cm

FRAME Hard wood combined with plywood and particle board covered with a Dacron layer.

NOTE Model equipped with a manual mechanism to adjust each sofa seat depth into a real chaiselongue.

Mechanism not available on corner seat of 0763/0762 unit.

STRUCTURE En bois massif, multiplis et particules habillés d'une couche de dacron.

REMBOURRAGE Coussins d'assise, accoudoirs et dossiers réalisés en polyuréthane écologique à densité différenciée, recouvert avec une couche de dacron. Assise: 35 Kg/m3. Couche de dacron 450 gr/m2. Accoudoirs: 30 Kg/m3. Dacron 450 gr/m2. Dossiers: 30 Kg/m3. Dacron 450 gr/m2

Rembourrage de complément: 30 Kg/m3

REVETEMENT Cuir ou microfibre non déhoussable.

PIEDS Base en acier brillant, hauteur 14 cm

NOTE Les dossiers sont équipés d'un mécanisme manuel permettant de les déplacer facilement en position arrière, obtenant une profondeur d'assise plus importante et offrant la possibilité d'étendre les jambes pour un confort supérieur. Ce mécanisme n'est pas présent sur l'angle de l'élément batard 1 place angle peninsula.

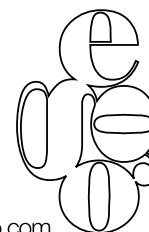
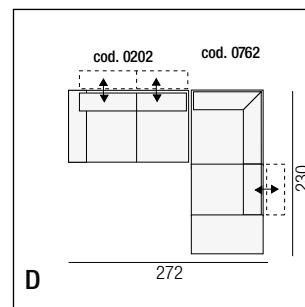
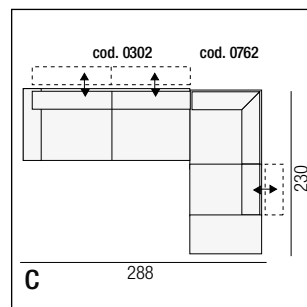
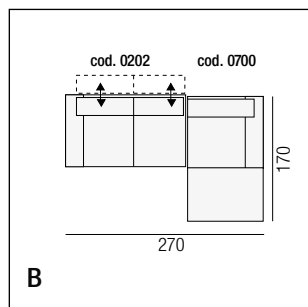
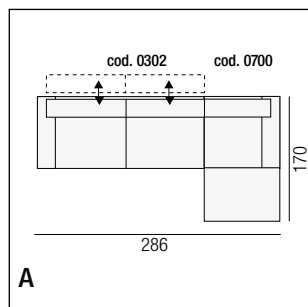
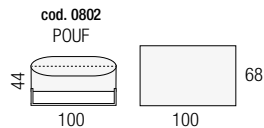
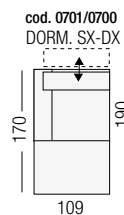
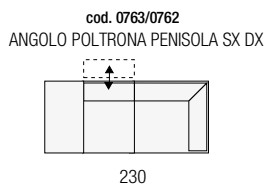
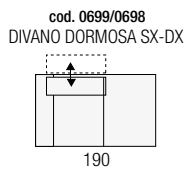
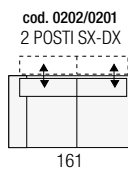
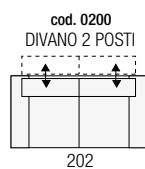
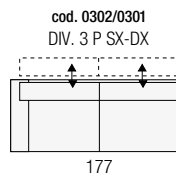
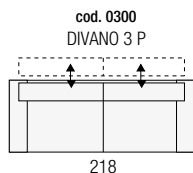
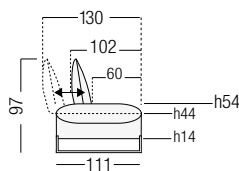
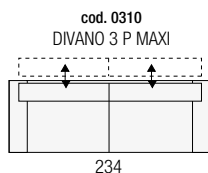

RIVESTIMENTO Pelle o microfibra non sfoderabile. Per le caratteristiche del rivestimento e della manutenzione vedere relative schede tecniche.

IMBOTTITURA Cuscini di seduta, braccioli, poggiatesta e spalliere poggiatesta reclinabili sono realizzate in poliuretano espanso a densità differenziate. Tutte le parti sopraelencate sono ricoperte da una termofalda di dacron autoestinguente. Cuscini di seduta: strato superiore: densità 30 kg/mc (soffice). Strato inferiore: densità 30 kg/mc (portante). Termofalda da 350 gr/mq. Braccioli: tampone superiore doppia densità 40 e 30 kg/mc. Termofalda da 350 gr/mq. Poggiatesta: densità 30 kg/mc. Termofalda da 350 gr/mq. Spalliere poggiatesta: densità 23 kg/mc. Termofalda da 350 gr/mq. Imbottiture di completamento: densità 21 kg/mc.

PIEDI In acciaio inox lucidato, H alla base del divano: cm 14,5

STRUTTURA Realizzata in legno abbinato a particelle di legno grezzo biodegradabile e pannelli di fibra di legno duro.

NOTE Gli schienali sono dotati di meccanismo manuale a cricchetto, reclinabili a seconda del comfort desiderato.

NOTE SU RIVESTIMENTO La variante con cucitura in cordoncino è possibile solo su rivestimento in pelle cat.B e cat.C

COVERING Leather, microfiber or fabric. Not removable.

PADDING Seat cushion, armrest, kidney rest and adjustable headrest: double density polyurethane foam covered with a Dacron layer.

Seat cushion: upper part: 30kg/m³ "soft comfort". Bottom part: 30 kg/m³ "hard comfort". Dacron layer: 350 gr/m²

Armrest: front and back part: 40 kg/m³. Upper part: 30 kg/m³. Dacron layer: 350 gr/m². Kidney rest: 30 kg/m³. Dacron layer 350 gr/m². Adjustable headrest: 23 kg/m³. Dacron layer: 350 gr/m²

FEET Polished stainless steel. Height 14,5 cm

FRAME Hard wood combined with plywood and particle board covered with a Dacron layer.

NOTE Model equipped with adjustable headrest.

Thick thread stitching available only with leather cat.B and cat.C

REVETEMENT Cuir ou microfibre non déhoussable.

REMBOURRAGE Coussins d'assise, cale-reins, accoudoirs et appuie-tête réclinables réalisés en polyuréthane écologique à double densité recouvert avec une couche de dacron.

Assise: Partie inférieure: 30 Kg/m³ (rigide). Partie supérieure 30 Kg/m³ (souple). Couche de dacron 350 gr/m². Accoudoirs: partie supérieure double densité 40 et 30 Kg/m³. Dacron 350 gr/m². Cale-reins: 30 Kg/m³. Dacron 350 gr/m².

Appuie-tête: 23 Kg/m³. Dacron 350 gr/m². Rembourrage de complément: 21 Kg/m³

PIEDS Base en acier inox brillant, hauteur 14,5 cm

STRUCTURE En bois massif, multiplis et particules habillés d'une couche de dacron.

NOTE Les dossiers sont équipés d'un mécanisme manuel au niveau des appuie-tête, réclinables selon le confort désiré.

Couture avec fil épais disponible seulement sur les cuirs cat. B et C

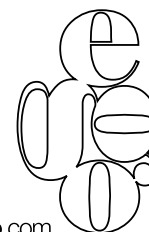
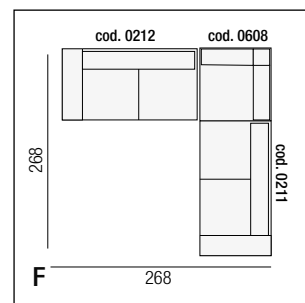
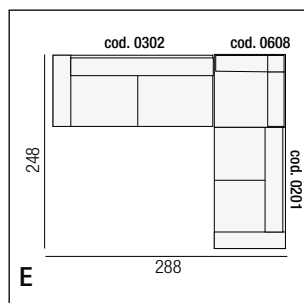
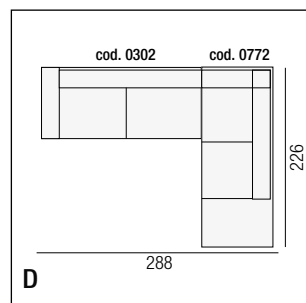
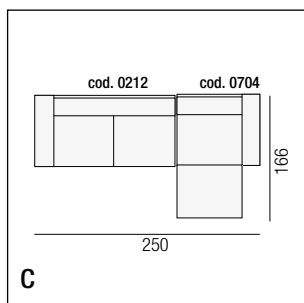
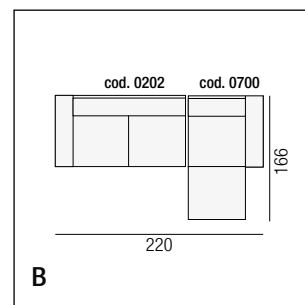
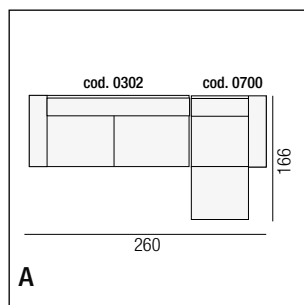
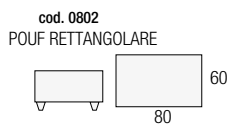
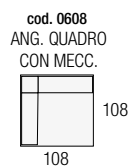
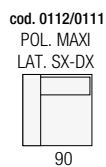
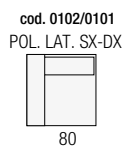
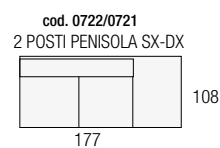
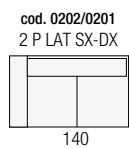
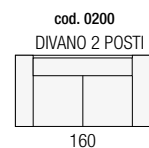
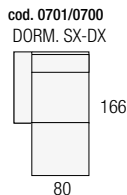
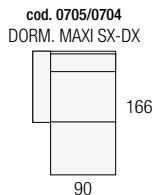
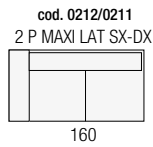
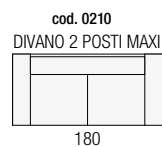
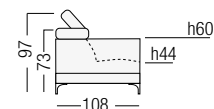
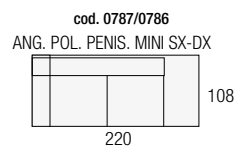
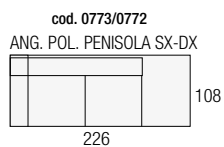
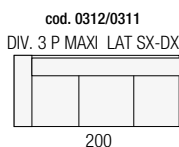
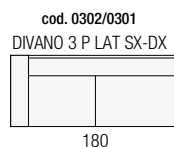
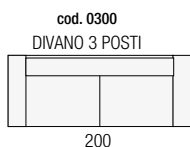

RIVESTIMENTO Pelle o microfibra non sfoderabile

IMBOTTITURA In poliuretano espanso ecologico a quote differenziate, ricoperta con falda di dacron ovattato.

L'imbottitura dei cuscini schienali è realizzata in fiocco.

PIEDI In ABS color legno h 5 cm

STRUTTURA Realizzata in legno abbinato a particelle di legno grezzo biodegradabile e pannelli di fibra di legno duro.

cod. 0300

DIVANO 3 P

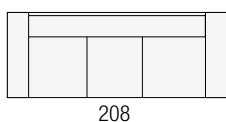

cod. 0302/0301

DIV. 3 P SX-DX

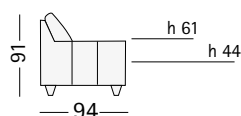
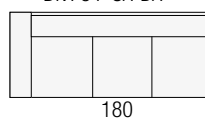

cod. 0200

DIVANO 2 POSTI

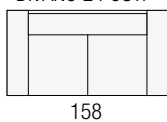

cod. 0202/0201

2 POSTI SX-DX

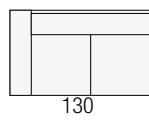

cod. 0722/0721

2 POSTI PEN. SX-DX

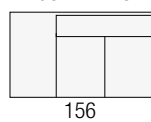

cod. 0701/0700

DORM. SX-DX

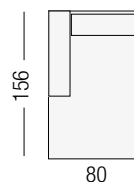

cod. 0100

POLTRONA

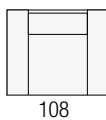

cod. 0102/0101

POLTR. SX-DX

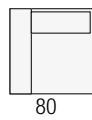

cod. 0712/0711

POLTR. PEN. SX-DX

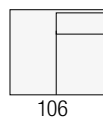

cod. 0602

ANGOLO

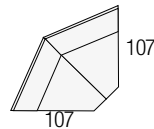

cod. 0761/0760

ANGOLO PENISOLA SX-DX

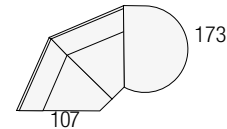

cod. 0801

POUF



cod. 0607/0606

ANGOLO CHICCIOLA SX-DX

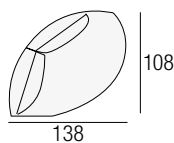

cod. 0809

POUFF SAGOMATO TONDO

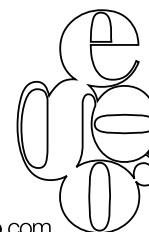
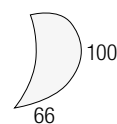

RIVESTIMENTO Pelle o microfibra non sfoderabile

IMBOTTITURA Braccioli, schienali e cuscini di seduta in poliuretano espanso ecologico a quote differenziate, ricoperti con falda di dacron. Densità cuscini di seduta 35 Kg/mc

PIEDI In Legno massello di faggio evaporato tinto con vernici ad acqua ecologica, nei colori: Noce, Noce brunito, Wengè.

STRUTTURA Realizzata in legno abbinato a particelle di legno grezzo biodegradabile e pannelli di fibra di legno duro.

Nella versione relax, il modello è realizzato con meccanismo combinato movimento schienale e poggiatesta. Disponibile sia manuale che elettrico con comando posizionato sul bracciolo laterale. L'elemento relax è sempre staccato dall'elemento fisso e viene agganciato con apposito sistema a baionetta.

RETE due pieghe elettrosaldata (140x197), *compresa aletta

MATERASSO in poliuretano espanso 120x175x12

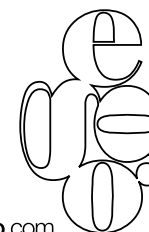
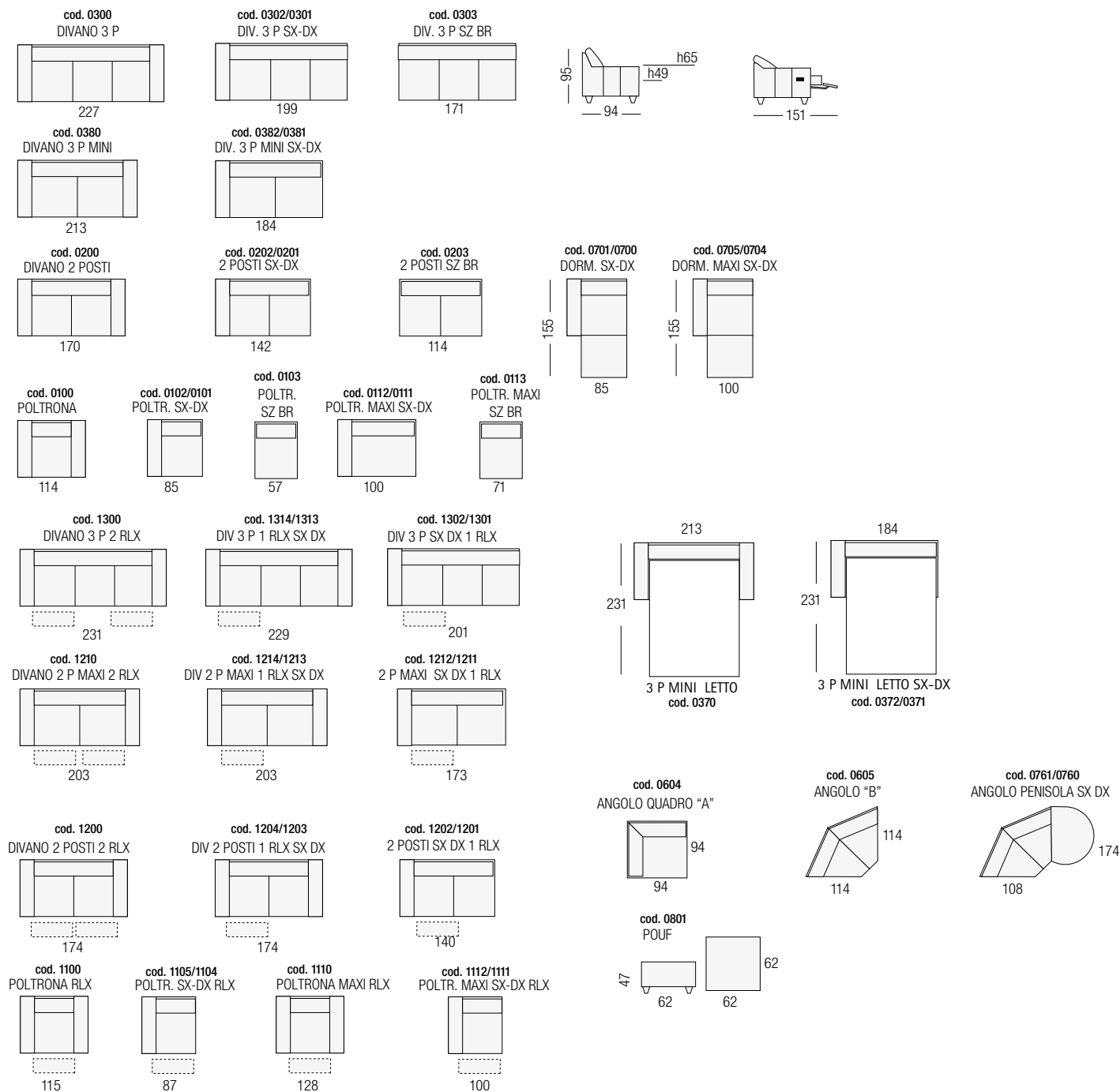

RIVESTIMENTO Pelle o microfibra non sfoderabile. Per le caratteristiche del rivestimento e la manutenzione vedere relative schede tecniche.

IMBOTTITURA Realizzate in poliuretano espanso ecologico a densità differenziate. Cuscini di seduta con densità 35 kg/mc per lo strato inferiore e 30 kg/mc per lo strato superiore. Cuscini schienali con densità 23 kg/mc per la zona poggiatesta reni e 30 kg/mc per la zona schiena. Tampone bracciolo di densità 45 kg/mc. Cuscini di seduta e schienali sono ricoperti da una termofalda di dacron autoestinguente da 450 gr/mq.

PIEDI Il modello è corredato di una base tubolare d'acciaio cromato con piedi integrati h cm 10.

STRUTTURA Realizzata in legno abbinato a particelle di legno grezzo biodegradabile e pannelli di fibra di legno duro.

NOTE Il divano 3 posti maxi dx-sx e 3 posti dx-sx sono dotati di 3 cuscini schienale. Su richiesta il modello può essere dotato di poggiatesta.

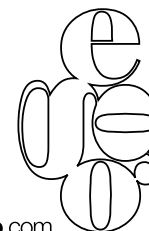
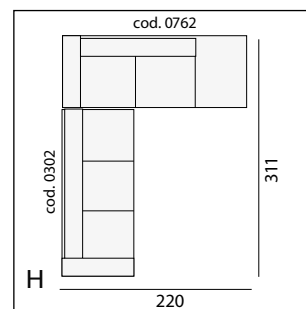
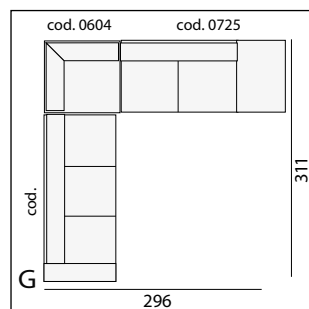
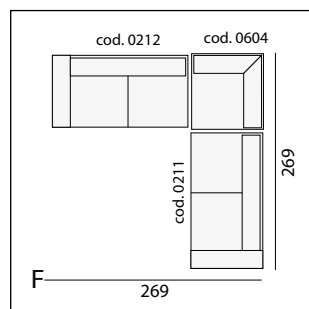
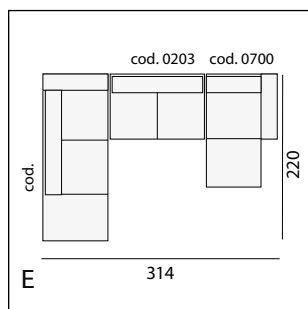
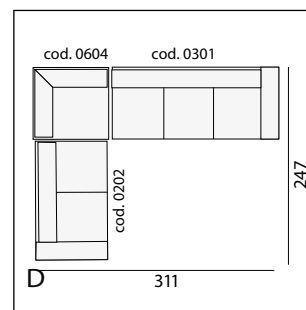
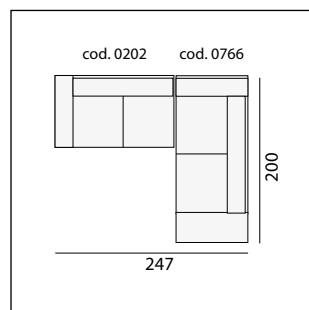
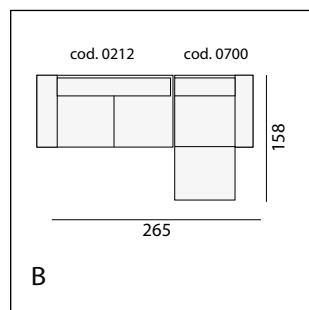
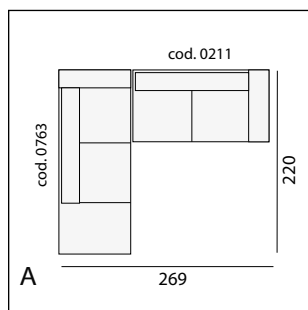
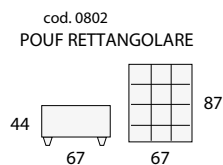
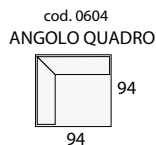
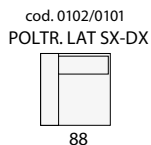
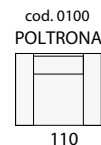
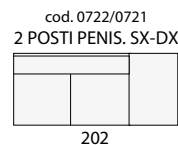
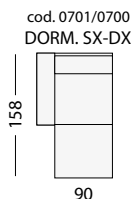
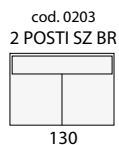
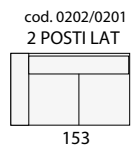
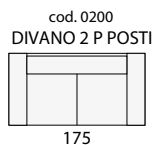
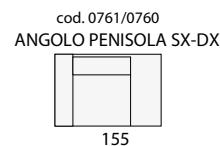
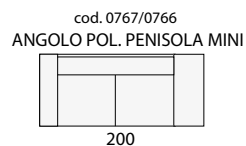
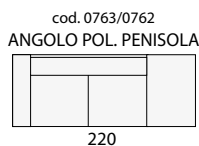
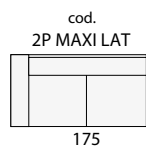
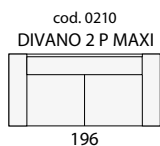
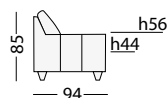
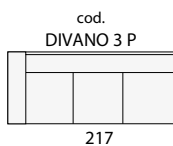
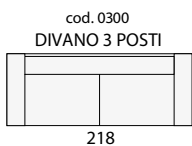
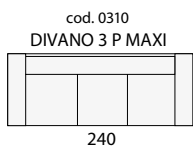

RIVESTIMENTO Pelle o microfibra, non sfoderabile. Per le caratteristiche del rivestimento e la manutenzione vedere relative schede tecniche.

IMBOTTITURA Cuscini di seduta e braccioli realizzati in poliuretano espanso. Cuscini di densità 30 kg/mc e braccioli di densità 23 kg/mc. Sia i cuscini che i braccioli sono ricoperti da una falda di dacron da 450 gr/mq. L'imbottitura degli schienali è realizzata in fiocchi di fibra poliestere siliconata, in involucro di tessuto non tessuto in fibra poliestere e polipropilene.

PIEDI In legno massello di faggio evaporato tinto con vernici ecologiche all' acqua, nei colori noce brunito o wengè. H cm 4.

STRUTTURA Realizzata in legno abbinato a particelle di legno grezzo biodegradabile e pannelli di fibra di legno duro.

RETE due pieghe elettrosaldata (3 POSTI 150x186), (2 P MAX 120x186).

MATERASSO a molle, optional in poliuretano espanso (3 POSTI 130x180x12), (2 P MAX 100x180x12).

COVERING Leather, microfiber or fabric. Not removable.

PADDING Ecologic polyurethane foam.

Seat cushion 30kg/m3 covered with a dacron layer 450gr/m2

Armrest 23kg/m3 covered with a dacron layer 450gr/m2

Backrest cushion: siliconed polyester fibre

FEET Beech feet available with dark walnut or wengè finishing. Height: 4cm

FRAME Hard wood combined with plywood and particle board covered with dacron layer.

BED BASE Electro-welded 2-ply (3 seater 150x186cm, 2 seater maxi 120x186cm)

MATRESS Spring or polyurethane on demand (3 seater 130x180x12cm, 2 seater maxi 100x180x12cm)

REVÊTEMENT Cuir, microfibre ou tissu non déhoussable.

REMBOURRAGE Coussins d'assise et accoudoirs en polyuréthane écologique habillé d'un couche de dacron 450 gr/m2.

Coussins d'assise: 30kg/m3. Accoudoirs: 23 kg/m3.

Dossiers: flocons de mousse.

PIED Hêtre massif. Finition disponible: noyer bruni ou wengè. Hauteur 4cm.

STRUCTURE En bois massif, multiplis et particules habillés d'un couche de dacron.

SOMMIER Electro-soudé à 2 plis (3 places cm 150x186, 2places maxi 120x186)

MATELAS À ressorts, sur demande en polyuréthane (3 places 130x180x12, 2places maxi 100x180x12)

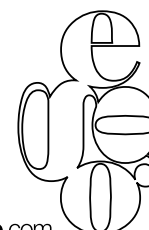
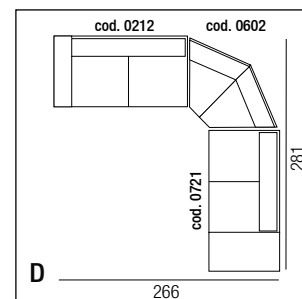
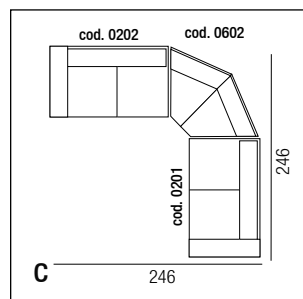
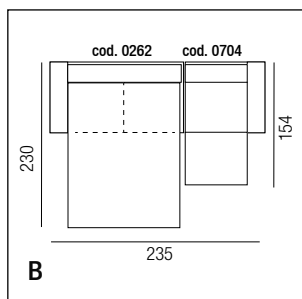
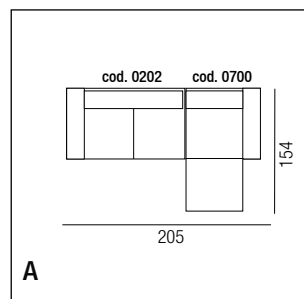
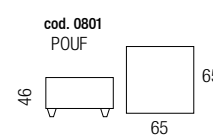
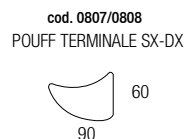
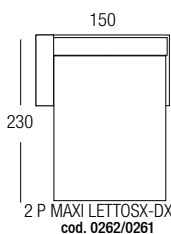
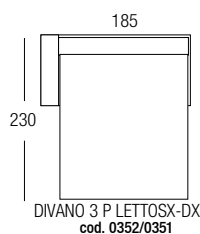
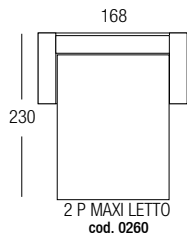
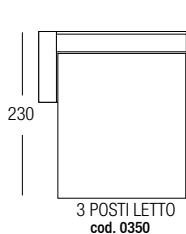
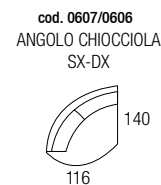
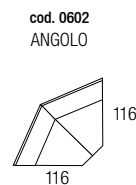
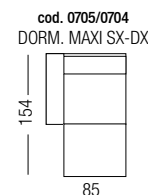
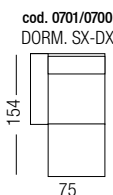
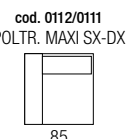
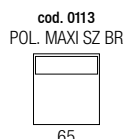
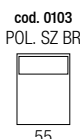
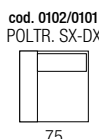
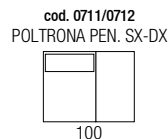
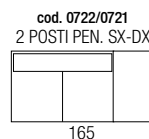
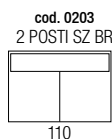
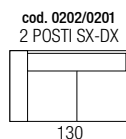
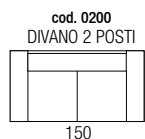
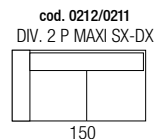
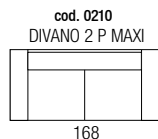
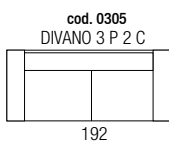
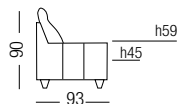
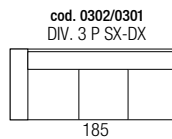
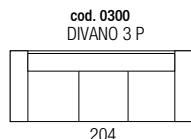

RIVESTIMENTO Pelle o microfibra non sfoderabile. Per le caratteristiche del rivestimento e della manutenzione vedere relative schede tecniche.

IMBOTTITURE Cuscini di seduta, braccioli ed imbottiture di completamento sono realizzati in poliuretano espanso a densità differenziate e sono ricoperti da una termofalda di dacron autoestinguente. Cuscini di schienale e poggiatesta sono realizzati in fibra di poliestere siliconata in fiocchi.

Cuscini di seduta: densità 30 kg/mc. Termofalda da 350 gr/mq.

Braccioli: densità 23 kg/mc. Termofalda da 350 gr/mq.

Imbottiture di completamento: densità 21 kg/mc.

PIEDI in ABS colore legno wengè da cm.8

STRUTTURA Realizzata in legno abbinato a particelle di legno grezzo biodegradabile e pannelli di fibra di legno duro.

RETE due pieghe elettrosaldata (3 POSTI 150x186).

MATERASSO a molle, optional in poliuretano espanso (3 POSTI 130x180x12).

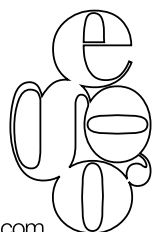
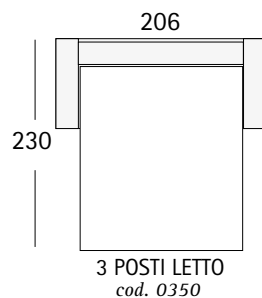
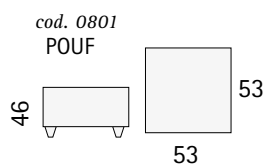
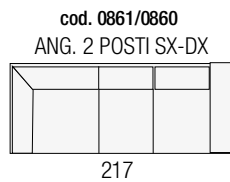
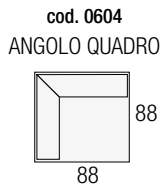
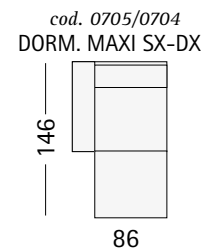
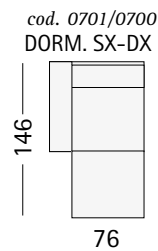
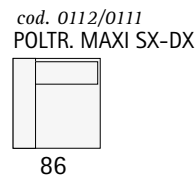
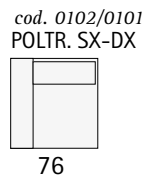
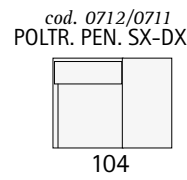
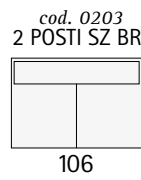
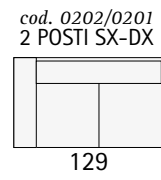
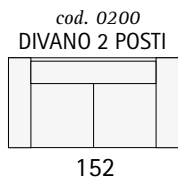
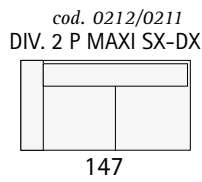
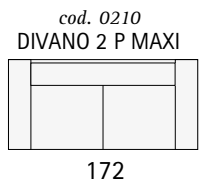
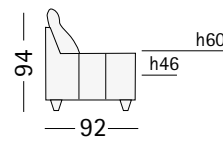
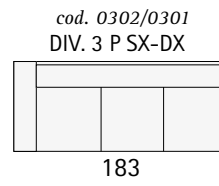
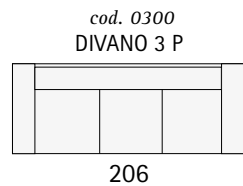

RIVESTIMENTO Pelle o microfibra, non sfoderabile. Per le caratteristiche del rivestimento e la manutenzione, vedere relative schede tecniche.

IMBOTTITURA Cuscino di seduta realizzato in poliuretano espanso di densità 30 kg/mc ricoperto da una falda di dacron da 450 gr/mq. Schienali realizzati in poliuretano espanso di densità 18 kg/mc ricoperti da una falda di dacron da 450 gr/mq. Braccioli realizzati in poliuretano espanso di densità 21 kg/mc ricoperto da falde di dacron da 100 e da 200 gr/mq. Poggiatesta realizzato in poliuretano espanso a densità differenziata da 18 kg/mc e 30 kg/mc, ricoperto da una falda di dacron da 450 gr/mq. Imbottiture di completamento in poliuretano espanso di densità 21 kg/mc.

PIEDI In alluminio lucidato, h 14 cm.

STRUTTURA Realizzata in legno abbinato a particelle di legno grezzo biodegradabile e pannelli di fibra di legno duro.

NOTE Gli schienali sono dotati di meccanismi manuali con cricchetti a scatti, reclinabili a seconda del comfort desiderato.

COVERING Leather, microfiber or fabric. Not removable.

PADDING Ecologic polyurethane foam.

Seat cushion: 30kg/m3 density and backrest cushion 18kg/m3 density covered with a dacron layer 450gr/m2. Armrest cushion: 21kg/m3 density covered with a dacron layer 100gr/m2 and 200gr/m2. Headrest: double density ecologic polyurethane foam 30 kg/m3 and 18 kg/m3 covered with a dacron layer 450gr/m2.

FEET Polished aluminum. Height: 14 cm.

FRAME Hard wood combined with plywood and particle board covered with a Dacron layer.

NOTE Adjustable headrest.

REVETEMENT Cuir, microfibre ou tissu non déhoussable.

REMBOURRAGE Coussins d'assise: polyuréthane densité 30 kg/m3 recouverts d'une couche de Dacron de 450 gr/m2. Dossiers: polyuréthane densité 18 kg/m3 recouverts d'une couche de Dacron de 450 gr/m2. Accoudoirs: polyuréthane densité 21 kg/m3 recouverts d'une double couche de Dacron 100 et 200 gr/m2. Appuis-tête: polyuréthane à densité différenciée de 18 et 30 kg/m3, recouvert d'une couche de Dacron 450gr/m2.

Rembourrage de complément en polyuréthane 21kg/m3.

PIED Aluminium brillant, h 14 cm.

STRUCTURE En bois massif, multiplis et particules habillés d'un couche de dacron.

NOTE Les dossiers sont équipés d'un mécanisme manuel au niveau des appuis-tête, réclinables selon le confort désiré.

cod. 0310
DIVANO 3 P MAXI

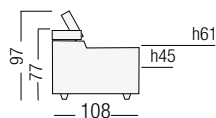
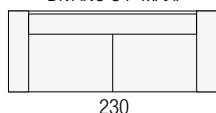

cod. 0300
DIVANO 3 P

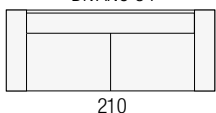

cod. 0302/0301
DIV. 3 P SX-DX

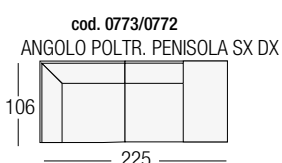
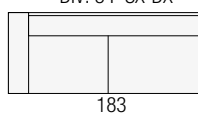

cod. 0210
DIVANO 2 P MAXI



cod. 0212/0211
DIV. 2 P MAXI SX-DX

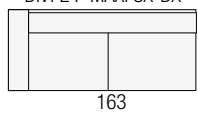

cod. 0200
DIVANO 2 POSTI

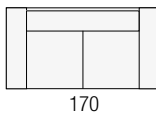

cod. 0202/0201
DIV. 2 P SX-DX

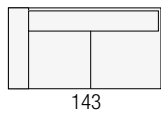

cod. 0100
POLTRONA

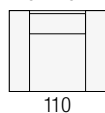

cod. 0701/0700
DORM. SX-DX

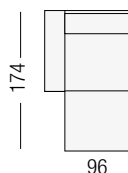

cod. 0608
ANGOLO QUADRO (mecc.)

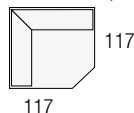

cod. 0103
POLTRONA CENTRALE



cod. 0801
POUF

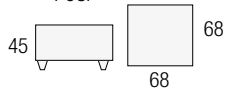

cod. 0802
POUF RETTANGOLARE

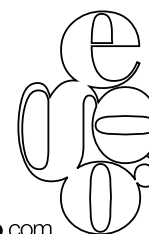
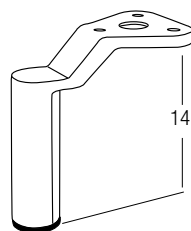
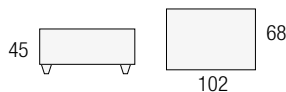

STRUTTURA Realizzata in legno abbinato a particelle di legno grezzo biodegradabile e pannelli di fibra di legno duro.

IMBOTTITURE In poliuretano espanso ecologico a densità differenziate.

Cuscino di seduta versione fissa di densità 28 kg/mc, versione letto 30 kg/mc.

Cuscini schienali di densità 30 kg/mc. Braccioli di densità 40 kg/mc. Il cuscino di seduta è ricoperto da una termofalda di dacron autoestinguente da 350 gr/mq. La struttura ed i cuscini schienali sono rivestiti da una falda di tomana (ovatta resinata accoppiata con tessuto non tessuto).

VERSIONE LETTO Le versioni letto sono dotate di reti a 2 pieghe elettrosaldate, realizzate in acciaio ad alta resistenza, verniciate a forno con polveri epossidiche.

Reti divano 3 posti: 180 x 201; divano 2 posti maxi: 160 x 201; 2 posti: 140 x 201; poltrona: 90 X 201;

Materassi in poliuretano espanso 3 posti: 160 x 193 x 13; 2 posti maxi: 140 x 193 x 13; 2 posti: 120 x 193 x 13; poltrona: 70 X 193 X 13;

RIVESTIMENTO Pelle non sfoderabile, tessuto e microfibra sfoderabile. Per le caratteristiche del rivestimento e la manutenzione vedere relative schede tecniche.

PIEDINI piede in acciaio cromato.

NOTE Gli schienali sono dotati di meccanismi manuali con cricchetti a scatti, reclinabili a seconda del comfort desiderato.

NOTE SU RIVESTIMENTO La variante con cucitura in cordoncino è possibile solo su rivestimento in pelle cat.B e cat.C

FRAME Hard wood combined with plywood and particle board covered with a dacron layer.

PADDING Seat cushion, backrest cushion and armrest: double density polyurethane foam covered with dacron layer 450gr/m2

Seat cushion 28 kg/m3 fix version – 30 kg/m3 sofabed version

Backrest cushion 30kg/m3

Armrest cushion 40kg/m3

Seat cushion covered with dacron layer 350gr/m2

Frame and backrest cushions covered a layer of cotton wood coupled with "non-woven" fabric

SOFABED Electro-welded orthopaedic bed base with elastic belts support in the seating area. Mechanism equipped with pillows storage space

Bed Base 3 seater: 180 x 201; 2 seater maxi: 160 x 201;

2 seater: 140 x 201; armchair: 90 X 20

Mattress 3 seater: 160 x 193 x 13; 2 seater maxi: 140 x 193 x 13;

2 seater: 120 x 193 x 13; armchair: 70 X 193 X 13;

COVERING Leather (not removable), fabric or microfiber, (removable).

FEET chrome-plated steel feet.

NOTE Adjustable headrest.

Thick thread stitching available only with leather cat.B and cat.C

CARCASSE En bois massif, multiplis et particules habillés d'un couche de dacron.

REMBOURRAGE en polyuréthane écologique a densité différenciée. Assise version fixe densité 28 kg/mc (version avec lit 30 kg/mc) habillé d'un couche de dacron (densité 350 gr/m2). Dossier: densité 30 kg/mc. Accoudoir: 40 kg/mc. Coussin de dossier et accoudoir habillé par une couche de dacron accouplé avec tissu "non-woven"

CANAPÉ-LIT Convertible à mailles électrosoudées, Espace de rangement ses oreillers. Assises sur sangles élastiques croisées.

Sommier 3 places 180 x 201; 2 places maxi: 160 x 201;

2 places 140 x 201; fauteuil: 90 X 201;

Couchage 3 places: 160 x 193 x 13; 2 places maxi: 140 x 193 x 13;

2 places: 120 x 193 x 13; fauteuil: 70 X 193 X 13;

REVÊTEMENT: Cuir (revêtement fixe). Microfibre ou tissu (revêtement déhoussable)

PIED: pied en acier chromé.

NOTE Les dossiers sont équipés d'un mécanisme manuel au niveau des appuie-tête, réclinables selon le confort désiré.

Couture avec fil épais disponible seulement sur les cuirs cat. B et C

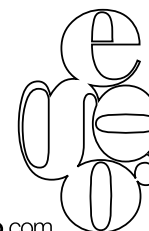
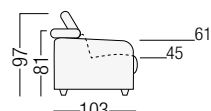
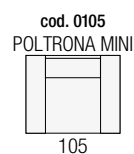
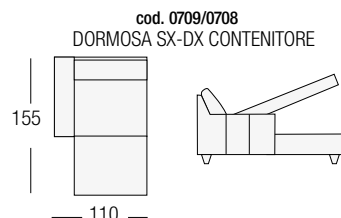
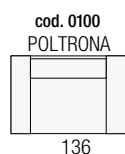
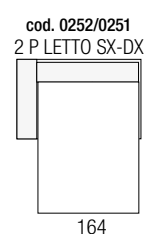
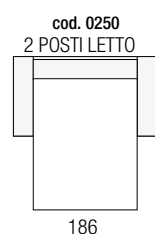
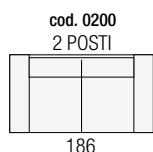
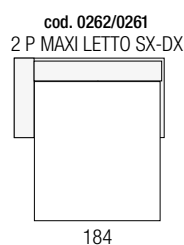
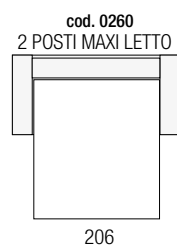
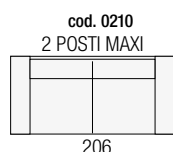
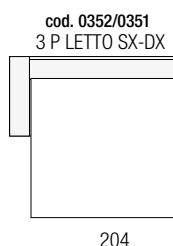
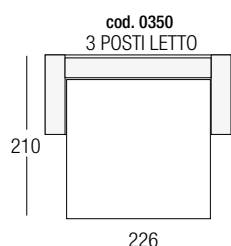
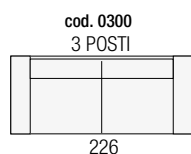

RIVESTIMENTO Pelle o microfibra non sfoderabile

IMBOTTITURA Braccioli, schienali e cuscini di seduta in poliuretano espanso ecologico a quote differenziate, ricoperti con falda di dacron. Densità cuscini di seduta 35 Kg/mc

PIEDI In Legno massello di faggio evaporato tinto con vernici ad acqua ecologica, nei colori: Noce, Noce brunito, Wengè. H cm 5

STRUTTURA Realizzata in legno abbinato a particelle di legno grezzo biodegradabile e pannelli di fibra di legno duro.

Nella versione relax. il modello è realizzato con meccanismo combinato movimento schienale e poggiatesta. Disponibile sia manuale che elettrico con comando posizionato sul bracciolo laterale. L'elemento relax è sempre staccato dall'elemento fisso e viene agganciato con apposito sistema a baionetta.

RETE due pieghe elettrosaldata (150x197*), *compresa aletta

MATERASSO in poliuretano espanso 130x175x12

FRAME Hardwood combined with plywood and particle board covered by a layer of polyurethane foam.

PADDING Seat cushion, armrests and backrests are made in polyurethane foam with varying density.

Seat cushions: Density 35 Kg/m3

COVERING Leather or microfiber. Not removable. Please check covering details for care instructions.

FEET Made of solid beech wood stained with ecological water based paints available in the following colours: walnut, burnished walnut, wengè, H: 5 cm

NOTE The relax version is made with combined mechanism: footrest-backrest.

Available with manual or electric mechanism, with controls placed on the armrest side. The part with relax is always delivered separately and connected to the fixed part by made for purpose bayonet fittings.

BED BASE Two folds electro welded (150 x 197*), *flap included

MATTRESS Polyurethane foam 130 x 157 x 12

STRUCTURE En bois, multiples et particules habillés d'une couche de polyuréthane expansé.

REMBOURRAGE Coussins d'assise, accoudoirs, et dossiers en polyuréthane expansé à double densité.

Coussins d'assise: Densité 35 kg/m3

REVETEMENT Cuir ou microfibre non déhoussable. Pour les caractéristique du revêtement aussi bien que pour l'entretien veuillez consulter les fiches techniques appropriés.

PIEDS En hêtre massif teinté avec vernis écologiques à base d'eau, disponible dans les couleurs noyer, noyer bruni et wengè. H 5 cm.

NOTE En version relax le modèle est réalisé avec mécanique combinée repose pieds/dossiers. Disponible en version manuelle ou électrique avec commande située sur le coté de l'accoudoir. L'élément avec relax est toujours séparé des éléments fixes et relié avec un système à baïonnette.

SOMMIER Deux plis électrosauté (150x197*), *compris rabat

MATELAS En polyuréthane expansé 130 x 157 x 12

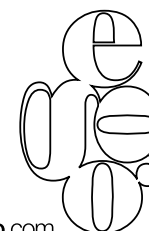
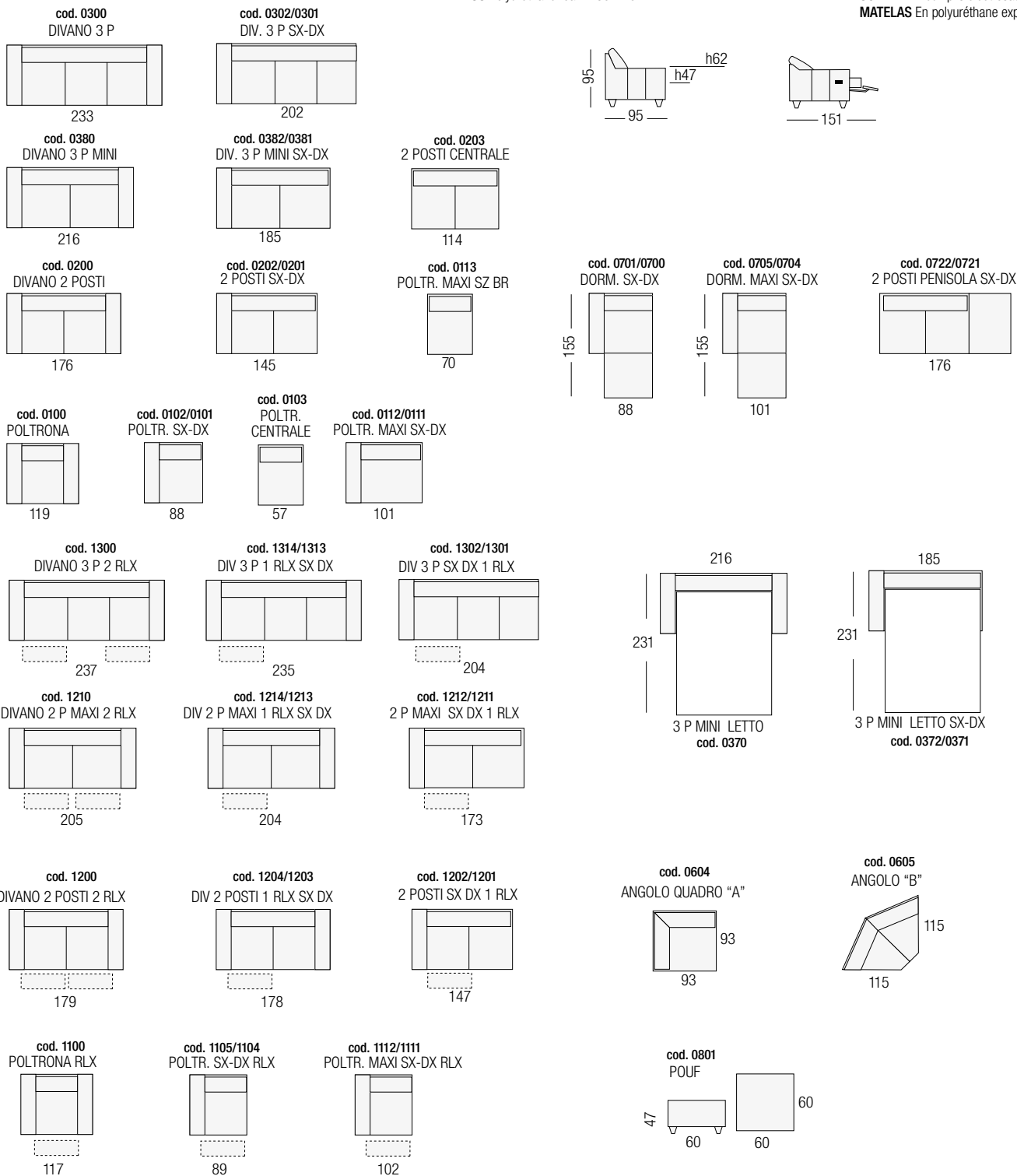

RIVESTIMENTO Pelle o microfibra non sfoderabile. Per le caratteristiche del rivestimento e della manutenzione vedere relative schede tecniche.

IMBOTTITURA Cuscini di seduta, braccioli e schienali sono realizzati in poliuretano espanso a densità differenziate. Tutte le parti sopraelencate sono ricoperte da una termofalda di dacron autoestinguente. Cuscini di seduta: densità 35 kg/mc. Termofalda da 450 gr/mq. Braccioli: densità 30 kg/mc. Termofalda da 450 gr/mq. Schienali: densità 30 kg/mc. Termofalda da 450 gr/mq. Imbottiture di completamento: densità 30 kg/mc.

PIEDI Slitta in acciaio lucidato, H alla base del divano: cm 14

STRUTTURA Realizzata in legno abbinato a particelle di legno grezzo biodegradabile e pannelli di fibra di legno duro.

COVERING Leather, microfiber or fabric. Not removable.

PADDING Seat cushion, armrest and backrest: polyurethane foam covered with a Dacron layer. Seat cushion 35kg/m3. Dacron layer: 450 gr/m2

Armrest and backrest: 30 kg/m3. Dacron layer: 450 gr/m2

FEET Polished stainless steel base. Height 14 cm

FRAME Hard wood combined with plywood and particle board covered with a Dacron layer.

STRUCTURE En bois massif, multiplis et particules habillés d'une couche de dacron.

REMBOURRAGE Coussins d'assise, accoudoirs et dossiers réalisés en polyuréthane écologique à densité différenciée, recouvert avec une couche de dacron. Assise: 35 Kg/m3. Couche de dacron 450 gr/m2. Accoudoirs: 30 Kg/m3. Dacron 450 gr/m2. Dossiers: 30 Kg/m3. Dacron 450 gr/m2

Rembourrage de completamento: 30 Kg/m3

REVETEMENT Cuir ou microfibre non déhoussable.

PIEDS Base en acier brillant, hauteur 14 cm

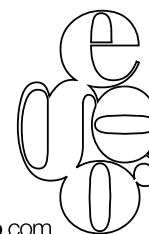
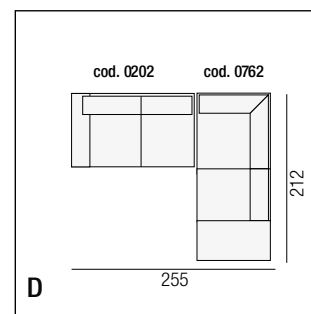
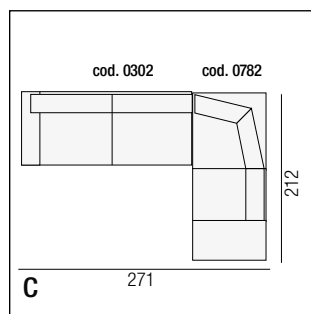
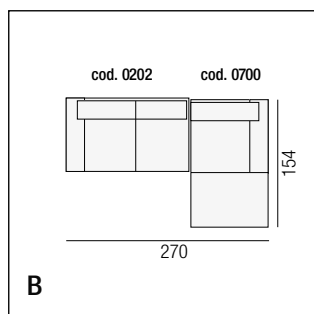
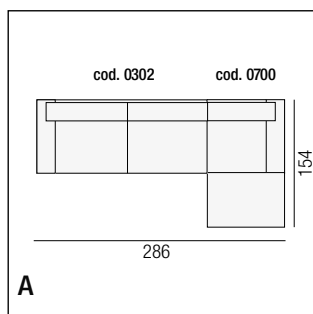
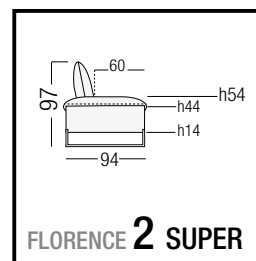
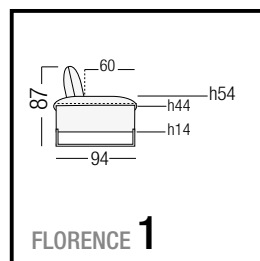
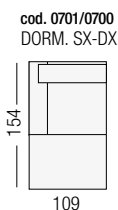
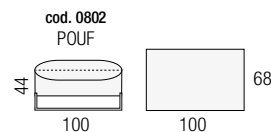
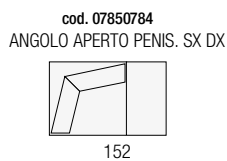
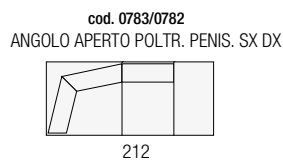
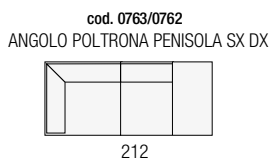
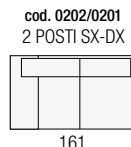
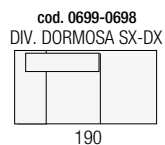
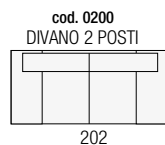
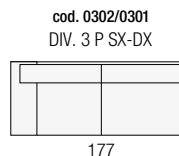
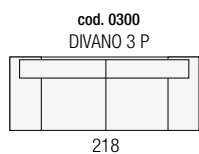
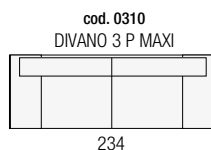

STRUTTURA Realizzata in legno abbinato a particelle di legno grezzo biodegradabile e pannelli di fibra di legno duro.

IMBOTTITURE Cuscini di seduta, braccioli, poggiatesta e spalliere poggiatesta reclinabili sono realizzate in poliuretano espanso. Tutte le parti sopraelencate sono ricoperte da una termofalda di dacron autoestinguente.

Cuscini di seduta: densità 30 kg/mc. Termofalda da 350 gr/mq.
Braccioli e poggiatesta: densità 25 kg/mc. Termofalda da 350 gr/mq.
Spalliere poggiatesta: densità 23 kg/mc. Termofalda da 350 gr/mq.
Imbottiture di completamento: densità 18 kg/mc.

RIVESTIMENTO Pelle o microfibra non sfoderabile. Per le caratteristiche del rivestimento e della manutenzione vedere relative schede tecniche.

PIEDI In acciaio tubolare a sezione quadrata, cromati. H: cm 10
NOTE Nella versione relax il modello è dotato esclusivamente di meccanismo elettrico con comando posizionato sul lato esterno del divano, mentre le sedute centrali sono dotate di un pratico telecomando. I comandi possono agire indipendentemente tra di loro variando solo l'inclinazione della testiera oppure permettendo di distendere solo le gambe offrendo infinite possibilità di comfort. Gli elementi relax sono sempre staccati da quelli fissi e vengono agganciati con apposito sistema a baionetta. Nelle versioni fisse senza meccanismo relax in ogni caso è presente il cricchetto manuale nelle testiere.

COVERING Leather, microfiber or fabric. Not removable.

PADDING Seat cushion, armrest, kidney rest and headrest: polyurethane foam covered with a Dacron layer.

Seat cushion: 30 kg/m3. Dacron layer: 350 gr/m2
Armrest and kidney rest: 25kg/m3. Dacron layer: 350 gr/m2
Headrest: 23 kg/m3. Dacron layer 450 gr/m2

FRAME Hard wood combined with plywood and particle board covered with a Dacron layer.

FEET Tubular squared section chromium-plated steel. Height 10 cm

NOTE Model equipped with "double motor" electric recliner mechanism for an independent movement of the backrest and the foot rest. Both the extensions for headrest and footrest are chromium-plated. Fixed versions are always equipped with manually adjustable headrest.

RETEVEMENT Cuir ou microfibre non déhoussable.

REMBOURRAGE Coussins d'assise, cale-reins, accoudoirs et appuie-tête réclinables réalisés en polyuréthane écologique à double densité recouvert avec une couche de dacron.

Assise: densité 30 Kg/m3. Couche de dacron 350 gr/m2.
Accoudoirs et cale-reins: densité 25 Kg/m3. Dacron 350 gr/m2
Appuie-tête: densité 23 Kg/m3. Dacron 350 gr/m2
Rembourrage de complement: densité 18 Kg/m3

PIEDS Carrés en acier, chromé h 10 cm

STRUCTURE En bois massif, multiplis et particules habillés d'une couche de dacron.

NOTE La version est exclusivement relax électrique, actionnable avec commande électrique positionnée sur le coté externe de l'accoudoir, le relax central est quand à lui doté d'une télécommande. Les commandes peuvent agir indépendamment les uns des autres, variant seulement l'inclinaison de l'appuie-tête ou bien permettant d'étendre les jambes, offrant de nombreuses possibilités pour le confort. L'élément relax est toujours détaché du fixe et est attaché à ce dernier par un système spécifique à baionnette.
L'élément fixe sans relax est doté de mécanisme manuel au niveau des appuie-tête.

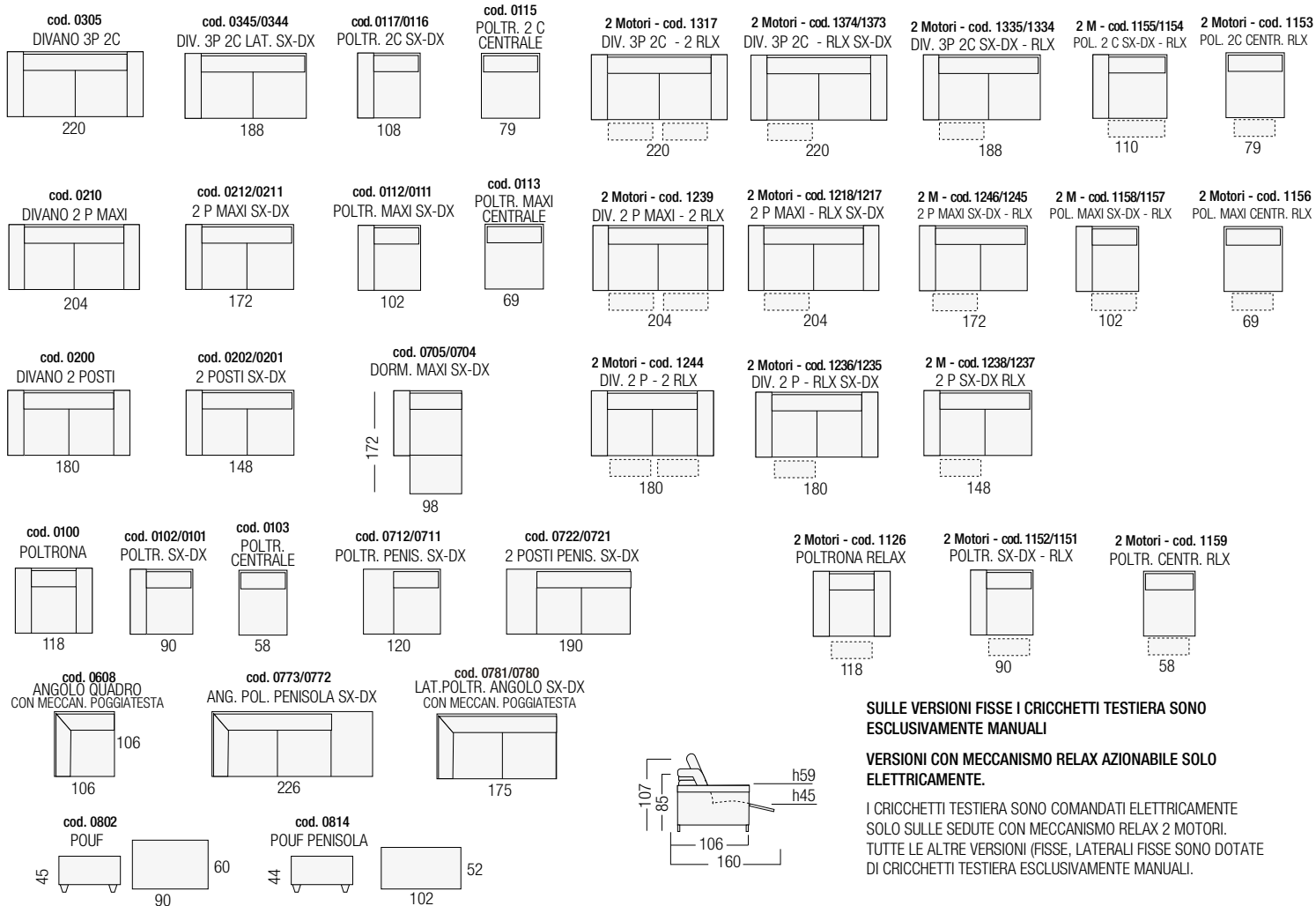

SULLE VERSIONI FISSE I CRICCHETTI TESTIERA SONO ESCLUSIVAMENTE MANUALI

VERSIONI CON MECCANISMO RELAX AZIONABILE SOLO ELETTRICAMENTE.

I CRICCHETTI TESTIERA SONO COMANDATI ELETTRICAMENTE SOLO SULLE SEDUTE CON MECCANISMO RELAX 2 MOTORI. TUTTE LE ALTRE VERSIONI (FISSE, LATERALI FISSE SONO DOTATE DI CRICCHETTI TESTIERA ESCLUSIVAMENTE MANUALI.

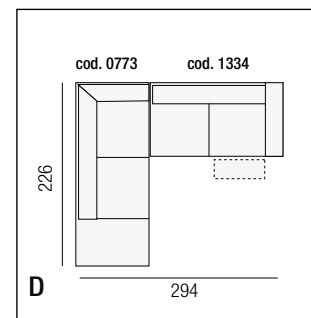
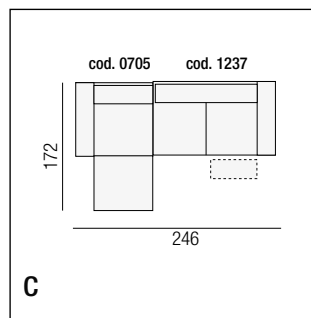
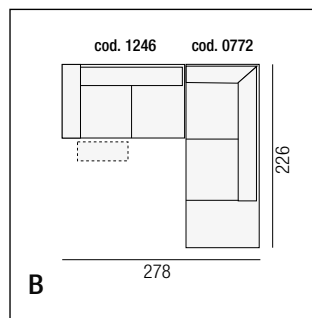
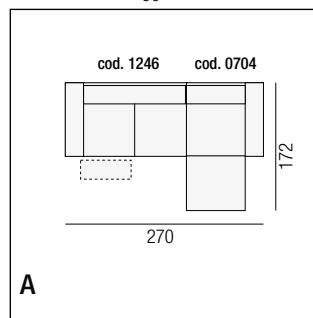
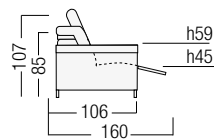

RIVESTIMENTO Pelle o microfibra non sfoderabile. Per le caratteristiche del rivestimento e della manutenzione vedere relative schede tecniche.

IMBOTTITURA Cuscini di seduta, braccioli, poggiatesta e spalliere poggiatesta reclinabili sono realizzate in poliuretano espanso a densità differenziate. Tutte le parti sopraelencate sono ricoperte da una termofalda di dacron autoestinguente.

Cuscini di seduta: strato superiore: densità 30 SS (30 kg/mc.) Strato inferiore: densità 30 SC (30 kg/mc.) Termofalda da 350 gr/mq.

Braccioli : densità 30 kg/mc. Termofalda da 350 gr/mq.

Poggiatesta : densità 23 kg/mc. Termofalda da 350 gr/mq.

Spalliere poggiatesta: densità 30 kg/mc. Termofalda da 350 gr/mq.

Imbottiture di completamento: densità 21 kg/mc.

PIEDI In legno tinto wengé con profilo cromato, H: cm 4

STRUTTURA Realizzata in legno abbinato a particelle di legno grezzo biodegradabile e pannelli di fibra di legno duro.

NOTE Nella variante relax il modello è realizzato con meccanismo combinato con movimento schienale poggiatesta. Disponibile esclusivamente in versione con motore elettrico con comando posizionato sul lato esterno del divano. L'elemento relax è sempre staccato da quello fisso e viene agganciato con apposito sistema a baionetta. Gli schienali sono dotati di meccanismo manuale a cricchetto, reclinabili a seconda del comfort desiderato.

COVERING Leather, microfiber or fabric. Not removable.

PADDING Seat cushion, armrest, kidney rest and adjustable headrest: double density polyurethane foam covered with a Dacron layer.

Seat cushion: upper part: 30kg/m³ "soft comfort". Bottom part: 30 kg/m³ "hard comfort". Dacron layer: 350 gr/m²

Armrest: 30 kg/m³. Upper part: 30 kg/m³. Dacron layer: 350 gr/m². Kidney rest: 23 kg/m³. Dacron layer 350 gr/m². Adjustable headrest: 30 kg/m³. Dacron layer: 350 gr/m²

FEET Wengé feet with chromium-plated profile, h 4 cm.

FRAME Hard wood combined with plywood and particle board covered with a Dacron layer.

NOTE Model equipped with adjustable headrest.

REVELEMENT Cuir ou microfibre non déhoussable.

REMBOURRAGE Coussins d'assise, cale-reins, accoudoirs et appuie-tête réclinables réalisés en polyuréthane écologique à double densité recouvert avec une couche de dacron.

Assise: Partie inferieure: 30 Kg/m³ (rigide). Partie superieure 30 Kg/m³ (souple). Couche de dacron 350 gr/m². Accoudoirs: densité 30 Kg/m³. Dacron 350 gr/m².

Cale-reins: 23 Kg/m³. Dacron 350 gr/m².

Appuie-tête: 30 Kg/m³. Dacron 350 gr/m². Rembourrage de complement: 21 Kg/m³

PIEDS En bois wengé avec profil chromé, h 4 cm.

STRUCTURE En bois massif, multiplis et particules habillés d'une couche de dacron.

NOTE Les dossiers sont équipés d'un mecanisme manuel au niveau des appuie-tête, réclinables selon le confort désiré.

cod. 0300

DIVANO 3 P

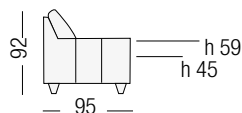
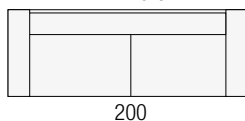

cod. 0200

DIVANO 2 POSTI

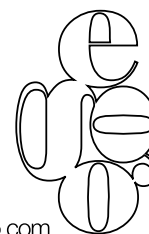
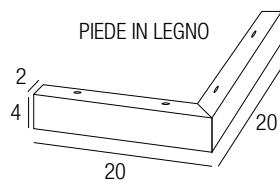
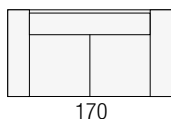

RIVESTIMENTO Pelle, microfibra oppure con rivestimento misto in pelle e microfibra. Non sfoderabile. Per le caratteristiche del rivestimento e della manutenzione vedere relative schede tecniche.

IMBOTTITURE Cuscini di seduta, braccioli e schienali sono realizzati in poliuretano espanso a densità differenziate. Tutte le parti sopraelencate sono ricoperte da una termofalda di dacron autoestinguente.

Cuscini di seduta: densità 30 kg/mc. Termofalda da 350 gr/mq.

Braccioli: densità 23 kg/mc. Termofalda da 350 gr/mq.

Schienali: densità 23 kg/mc. Zona poggiatesta: densità 30 kg/mc. Termofalda da 350 gr/mq.

Imbottiture di completamento: densità 21 kg/mc.

PIEDI In legno massello di faggio evaporato, tinti con vernici ad acqua ecologiche. Colori noce, noce brunito, wengè. H cm 4

STRUTTURA Realizzata in legno abbinato a particelle di legno grezzo biodegradabile e pannelli di fibra di legno duro.

STRUCTURE En bois, multiples et particules habillés d'une couche de dacron.

REMBOURRAGE Coussins d'assise, accoudoirs et dossiers en polyuréthane expansé à double densité. Toutes parties susdites sont recouvertes avec une couche de dacron.

Coussins d'assise: Densité 30 kg/m³ portante. Dacron 350 gr/m².

Accoudoirs: 23 kg/m³. Dacron 350 gr/m².

Dossiers: 23 kg/m³. Cales-reins : 30 kg/m³. Dacron 350/m².

Rembourrage de complément : densité 21 kg/m³.

REVETEMENT Cuir ou microfibre non déhoussable. Pour les caractéristique du revêtement aussi bien que pour l'entretien veuillez consulter la fiches techniques appropriés.

PIEDS En bois teinté coloris noyer, noyer foncé, wengué. H 4 cm.

FRAME Hardwood combined with plywood and particle board.

PADDING Seat cushion, armrests and backrests in polyurethane foam with varying density. All of the above parts are covers with a Dacron layer.

Seat cushions: density 30 kg/m³. Dacron layer 350 gr/m².

Armrest: 23 kg/m³. Dacron layer 350 gr/m².

Backs: 23 kg/m³. Dacron layer 350 gr/m².

Frame padding: 21 kg/m³

COVERING Leather or microfiber. Not removable. Please check covering details for care instructions.

FEET In wood. Colors available: walnut, dark walnut, wengué. H 4 cm.

cod. 0300

DIVANO 3 P

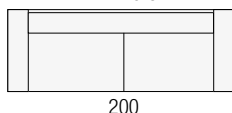

200

cod. 0302/0301

DIV. 3 P SX-DX



173

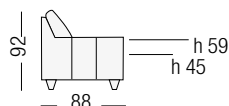

cod. 0210

DIVANO 2 P MAXI

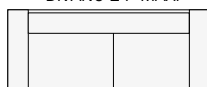

180

cod. 0212/0211

DIV. 2 P MAXI SX-DX

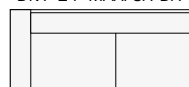

153

cod. 0200

DIVANO 2 POSTI



166

cod. 0202/0201

2 POSTI SX-DX

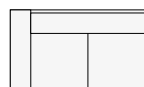

139

cod. 0701/0700

DORMOSA LAT. SX-DX

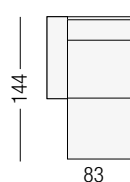

83

cod. 0102/0101

POLTR. LAT. SX-DX



83

cod. 0712/0711

POLTR. PEN. SX-DX

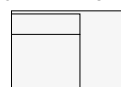

96

cod. 0607/0606

ANGOLO CHIOCCIOLA SX-DX



132

128

cod. 0763/0762

ANG. POL. PENISOLA SX-DX

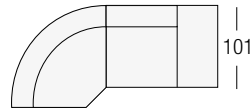

197

101

cod. 0602

ANGOLO



101

cod. 0808/0807

POUFF SAGOMATO SX-DX

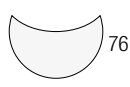

130

76

cod. 0801

POUFF



45

60

60

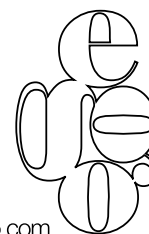

RIVESTIMENTO Pelle o microfibra non sfoderabile. Per le caratteristiche del rivestimento e della manutenzione vedere relative schede tecniche.

IMBOTTITURE Cuscini di seduta, braccioli e schienali sono realizzati in poliuretano espanso a densità differenziate. Tutte le parti sopraelencate sono ricoperte da una termofalda di dacron autoestinguente.

Cuscini di seduta: densità 30 SC e 30 NC kg/mc. Termofalda da 350 gr/mq. Braccioli: densità 30 SC kg/mc. Termofalda da 350 gr/mq.

Schienali: densità 30 SS e 30 SC kg/mc. Termofalda da 450 gr/mq. Imbottiture di completamento: densità 21 kg/mc.

STRUTTURA Realizzata in legno abbinato a particelle di legno grezzo biodegradabile e pannelli di fibra di legno duro.

PIEDI Struttura in acciaio lucidato, H alla base del divano: cm 13

NOTE Gli schienali sono dotati di meccanismo manuale a cricchetto, reclinabili a seconda del comfort desiderato.

COVERING Leather, microfiber or fabric. Not removable.

PADDING Seat cushion, armrest, and backrest: double density polyurethane foam covered with a Dacron layer.

Seat cushion: upper part: 30kg/m3 "soft comfort". Bottom part: 30 kg/m3 "normal comfort". Dacron layer: 350 gr/m2

Armrest: 30kg/m3 "soft comfort". Dacron layer: 350 gr/m2

Back rest: 30 kg/m3 "super soft" combined with 30kg/m3 "soft comfort". Dacron layer 450 gr/m2

FRAME Hard wood combined with plywood and particle board covered with a Dacron layer.

FEET Polished stainless steel. Height 13 cm

NOTE Model equipped with "leather-pull" adjustable headrest fully covered with leather also on the back part, 15 different positions available.

REVETEMENT Cuir ou microfibre non déhoussable.

REMBOURRAGE Coussins d'assise, accoudoirs et dossiers sont réalisés en polyuréthane écologique à double densité

Coussins d'assise: 30 SC et 30 NC Kg/m3. Dacron 350 gr/m2

Accoudoirs: 30 SC Kg/m3. Dacron 350 gr/m2

Dossiers: 30 SS et 30 SC Kg/m3. Dacron 450 gr/m2

Rembourrage de complement: 21 Kg/m3

STRUCTURE En bois massif, multiplis et particules habillés d'une couche de dacron.

PIED Structure en acier brillant, base du canapé H: 13 cm.

NOTE Les dossiers sont équipés d'un mécanisme manuel au niveau des appuie-tête, réclinables selon le confort désiré.

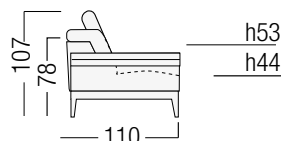
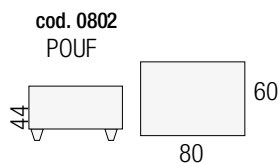
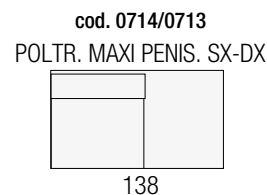
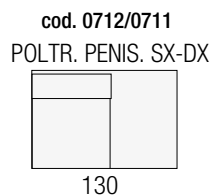
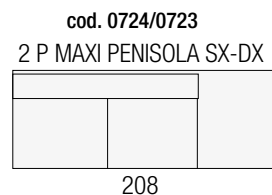
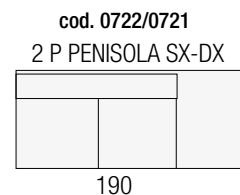
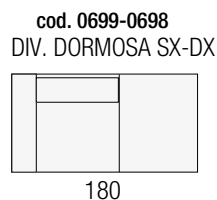
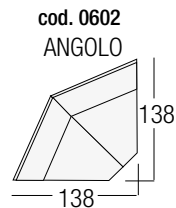
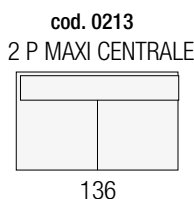
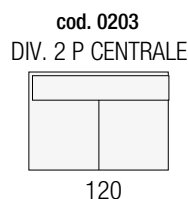
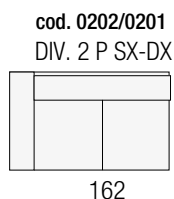
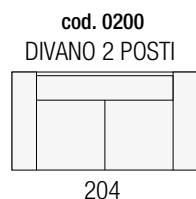
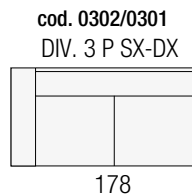
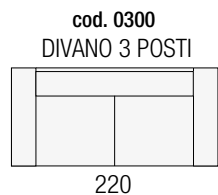
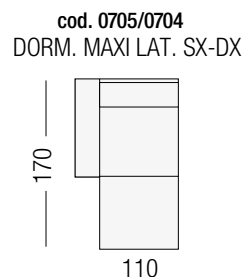
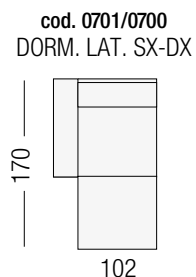
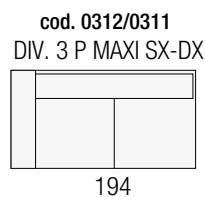
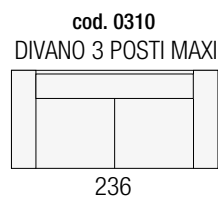

h53
h44

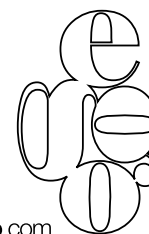

STRUTTURA Realizzata in legno abbinato a particelle di legno grezzo biodegradabile e pannelli di fibra di legno duro.

IMBOTTITURE Cuscini di seduta e braccioli sono realizzati in poliuretano espanso e sono ricoperti da una termofalda di dacron in fibra di poliestere autoestinguente. Cuscini di seduta: densità 30 kg/mc. Termofalda da 350 gr/mq.

Braccioli: densità 23 kg/mc. Termofalda da 350 gr/mq.

Schienali e poggiatesta: realizzati in fibra di poliestere siliconata in fiocchi, racchiusi in una fodera di TNT (tessuto non tessuto) in fibra di polipropilene.

Imbottiture di completamento: densità 21 kg/mc.

RIVESTIMENTO Pelle o microfibra non sfoderabile. Per le caratteristiche del rivestimento e della manutenzione vedere relative schede tecniche.

PIEDI in legno massello di faggio evaporato tinto con vernici ecologiche all'acqua. Colore wengé, noce o noce brunito. H = cm. 4

FRAME Hard wood combined with plywood and particle board covered with a dacron layer.

PADDING Seat cushion and armrest: polyurethane foam covered with a Dacron layer.

Seat cushion: 30kg/m3. Dacron layer: 350gr/m2

Armrest cushion: 23kg/m3. Dacron layer: 350gr/m2

Backrest cushion and kidney rest: siliconed polyester fibre.

COVERING Leather, microfiber or fabric. Not removable

Feet Beech feet. Available finishing: walnut, dark walnut and wengé. Height: 4cm

STRUCTURE En bois massif, multiplis et particules habillés d'une couche de dacron.

REMBOURRAGE Coussins d'assise et accoudoirs: polyuréthane écologique à densité différenciée.

Coussins d'assise: 30kg/m3 recouverts d'une couche de Dacron 350gr/m2.

Accoudoirs: 23kg/m3 recouverts d'une couche de Dacron 350gr/m2

Dossiers et cale-reins: flocons de mousse.

Rembourrage de complement: densité 21 Kg/m3

REVETEMENT Cuir ou microfibre non déhoussable.

PIEDS En bois de 4cm teinté noyer, noyer bruni ou wengé.

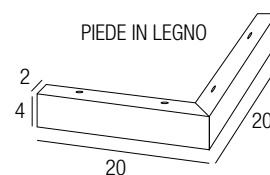
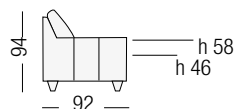
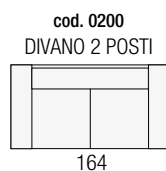
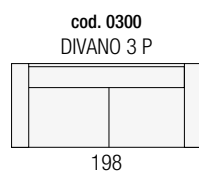

STRUTTURA Realizzata in legno abbinato a particelle di legno grezzo biodegradabile e pannelli di fibra di legno duro.

IMBOTTITURE Cuscini di seduta, braccioli, poggiatesta e spalliere poggiatesta reclinabili sono realizzate in poliuretano espanso a densità differenziate. Tutte le parti sopraelencate sono ricoperte da una termofalda di dacron autoestinguente.

Cuscini di seduta: strato superiore: densità 30 kg/mc (soffice). Strato inferiore: densità 30 kg/mc (portante). Termofalda da 350 gr/mq.
Braccioli: densità 25 kg/mc. Termofalda da 350 gr/mq.
Poggiatesta: densità 25 kg/mc. Termofalda da 350 gr/mq.
Spalliere poggiatesta: densità 23 kg/mc. Termofalda da 350 gr/mq.
Imbottiture di completamento: densità 21 kg/mc.

RIVESTIMENTO Pelle o microfibra non sfoderabile. Per le caratteristiche del rivestimento e della manutenzione vedere relative schede tecniche.

PIEDI In alluminio lucidato, H alla base del divano: cm 12

NOTE Gli schienali sono dotati di meccanismo manuale a cricchetto, reclinabili a seconda del comfort desiderato.

STRUCTURE En bois, multiplies et particules habillées d'une couche de dacron.

REMBOURRAGE Coussins d'assise, accoudoirs, cales-reins, dossiers et appuie-tête en polyuréthane expansé à double densité. Toutes parties susdites sont recouvertes avec une couche de dacron.

Coussins d'assise : Partie supérieure 30 kg/m3 (souple), partie inférieure 30 kg/m3 portante. Dacron 350 gr/m2.
Accoudoirs et cales-reins : 25 kg/m3. Dacron 350 gr/m2.
Dossiers et appuie-tête : 23 kg/m3. Dacron 350 gr/m2.
Rembourrage de complément : densité 21 kg/m3.

RETEMENT Cuir ou microfibre non déhoussable. Pour les caractéristiques du revêtement aussi bien que pour l'entretien veuillez consulter les fiches techniques appropriés.

PIEDS En métal brillant, H 12cm.

NOTES Les appuie-têtes sont équipés d'une mécanique manuelle à crémaillère.

FRAME Hardwood combined with plywood and particle board.

PADDING Seat cushion, armrests, lumbar supports, backrests and headrests are made in polyurethane foam with varying density. All of the above parts are covers with a Dacron layer.

Seat cushions: upper part: 30 kg/m3 "soft comfort".
Bottom part: 30 kg/m3 "normal comfort". Dacron layer 350 gr/m2.
Armrest and lumbar support: 25 kg/m3. Dacron layer 350 gr/m2.
Backs and headrests: 23 kg/m3. Dacron layer 350 gr/m2.

Frame padding: 21 kg/m3

COVERING Leather or microfiber. Not removable. Please check covering details for care instructions.

FEET Shiny metal H 12cm.

NOTE Headrests are equipped with manual adjustable mechanism.

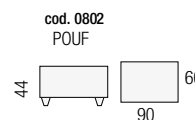
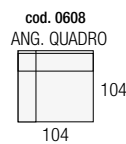
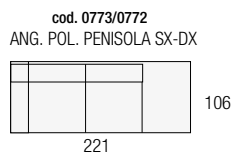
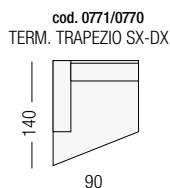
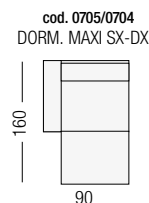
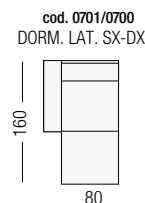
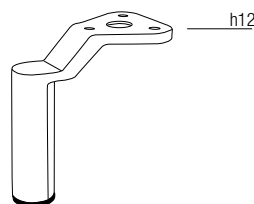
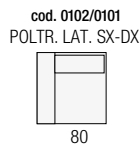
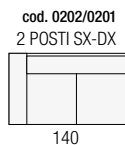
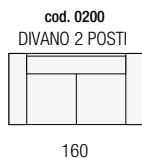
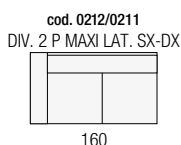
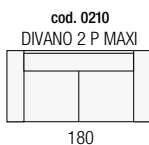
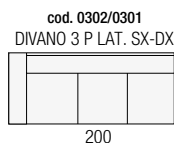
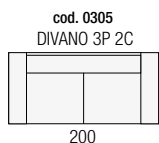
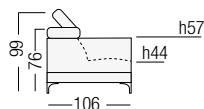
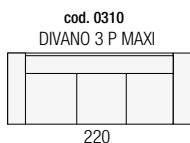

SMALL

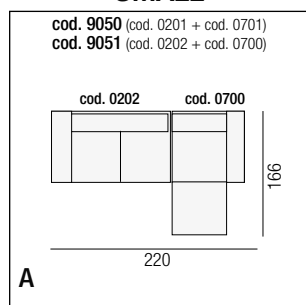

MEDIUM

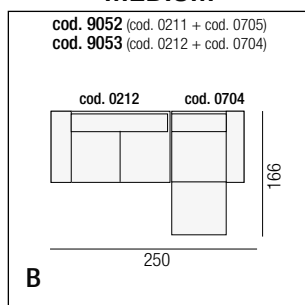

LARGE

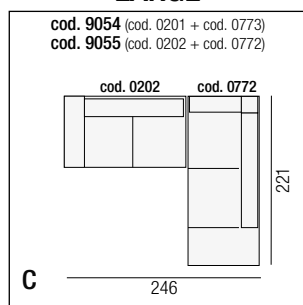

EXTRALARGE

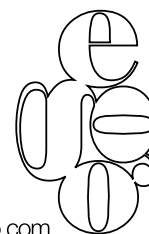
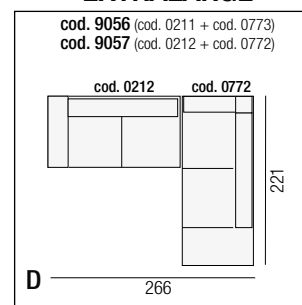

STRUTTURA Realizzata in legno abbinato a particelle di legno grezzo biodegradabile e pannelli di fibra di legno duro.

IMBOTTITURE Cuscini di seduta, braccioli e schienali sono realizzati in poliuretano espanso a densità differenziate. Tutte le parti sopraelencate sono ricoperte da una termofalda di dacron autoestinguente.

Cuscini di seduta: parte inferiore densità 35 kg/mc. Parte superiore densità 30 kg/mc. Termofalda da 450 gr/mq.

Braccioli: tampone superiore densità 45 kg/mc. Imbottiture di completamento bracciolo densità 21 kg/mc. Termofalda da 100 gr/mq. e da 200 gr/mq.

Schienali: parte superiore densità 18 kg/mc. Parte inferiore densità 21 kg/mc. Termofalda da 450 gr/mq.

Imbottiture di completamento: densità 21 kg/mc.

RIVESTIMENTO Pelle o microfibra non sfoderabile. Per le caratteristiche del rivestimento e della manutenzione vedere relative schede tecniche.

PIEDI In acciaio lucidato, H: cm 15

STRUCTURE En bois, multiplies et particules habillées d'une couche de dacron.

REMBOURRAGE Coussins d'assise, accoudoirs, et dossiers en polyuréthane expansé à double densité. Toutes parties susdites sont recouvertes avec une couche de dacron.

Coussins d'assise: Partie supérieure 30 kg/m3, partie inférieure 35 kg/m3 portante. Dacron 450 gr/m2.

Accoudoirs: Partie supérieure 45 kg/m3. Autres parties 21 kg/m3. Dacron 100 et 200 gr/m2.

Dossiers: Partie supérieure 18 kg/m3, partie inférieure 21 kg/m3. Dacron 450 gr/m2.

Rembourrage de complément : densité 21 kg/m3.

REVETEMENT Cuir ou microfibre non déhoussable. Pour les caractéristique du revêtement aussi bien que pour l'entretien veuillez consulter les fiches techniques appropriés.

PIEDS En métal brillant, H 15cm.

FRAME Hardwood combined with plywood and particle board.

PADDING Seat cushion, armrests and backrests are made in polyurethane foam with varying density. All of the above parts are covers with a Dacron layer.

Seat cushions: Upper part 30 kg/m3, bottom part 35 kg/m3. Dacron layer 450 gr/m2.

Armrests: Upper part 45 kg/m3. Remaining parts 21 kg/m3. Dacron layer 450 gr/m2.

Backrests: Upper part 18 kg/m3, bottom part 21 kg/m3. Dacron layer 450 gr/m2.

Frame padding: 21 kg/m3

COVERING Leather or microfiber. Not removable. Please check covering details for care instructions.

FEET Shiny metal H 15cm.

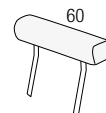
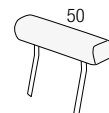
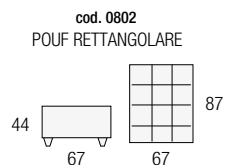
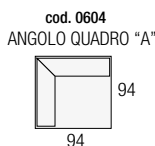
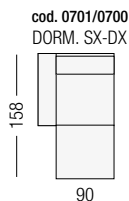
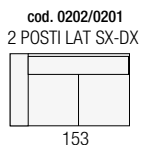
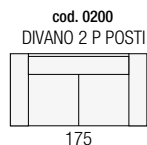
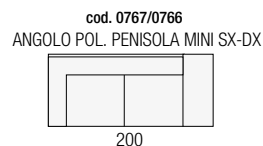
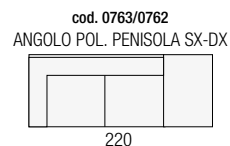
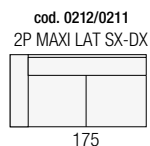
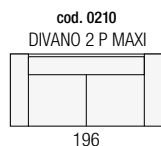
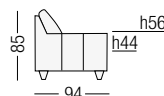
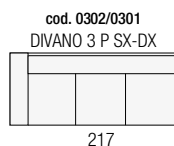
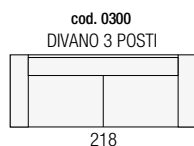
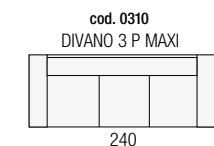

SMALL

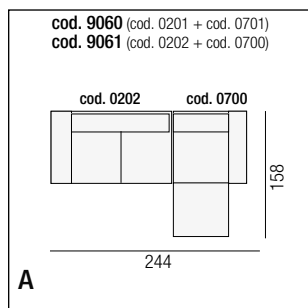

MEDIUM

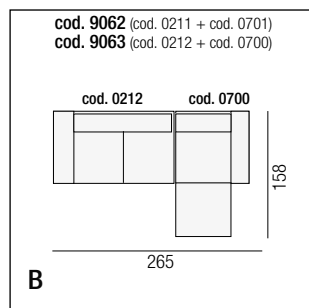

LARGE

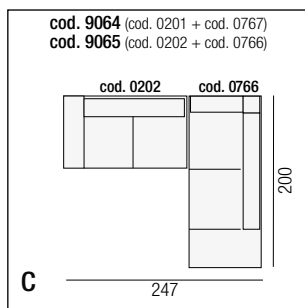

EXTRALARGE

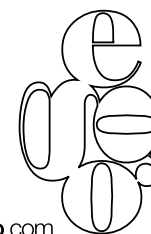
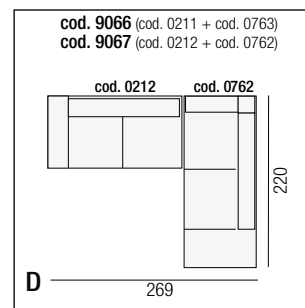

RIVESTIMENTO Pelle o microfibra non sfoderabile. Per le caratteristiche del rivestimento e della manutenzione vedere relative schede tecniche.

IMBOTTITURA Cuscini di seduta, braccioli e schienali sono realizzati in poliuretano espanso a densità differenziate. Tutte le parti sopraelencate sono ricoperte da una termofalda di dacron autoestinguente. Cuscini di seduta: densità 35 kg/mc. Termofalda da 450 gr/mq. Braccioli: densità 30 kg/mc. Termofalda da 450 gr/mq. Schienali: densità 30 kg/mc. Termofalda da 450 gr/mq. Imbottiture di completamento: densità 30 kg/mc.

PIEDI Slitta in acciaio lucidato, H alla base del divano: cm 14

STRUTTURA Realizzata in legno abbinato a particelle di legno grezzo biodegradabile e pannelli di fibra di legno duro.

COVERING Leather, microfiber or fabric. Not removable.

PADDING Seat cushion, armrest and backrest: polyurethane foam covered with a Dacron layer. Seat cushion 35kg/m3. Dacron layer: 450 gr/m2
Armrest and backrest: 30 kg/m3. Dacron layer: 450 gr/m2

FEET Polished stainless steel base. Height 14 cm

FRAME Hard wood combined with plywood and particle board covered with a Dacron layer.

STRUCTURE En bois massif, multiplis et particules habillés d'une couche de dacron.

REMBOURRAGE Coussins d'assise, accoudoirs et dossiers réalisés en polyuréthane écologique à densité différenciée, recouvert avec une couche de dacron. Assise: 35 Kg/m3. Couche de dacron 450 gr/m2. Accoudoirs: 30 Kg/m3. Dacron 450 gr/m2. Dossiers: 30 Kg/m3. Dacron 450 gr/m2
Rembourrage de complement: 30 Kg/m3

REVETEMENT Cuir ou microfibre non déhoussable.

PIEDS Base en acier brillant , hauteur 14 cm

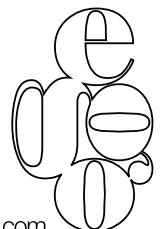
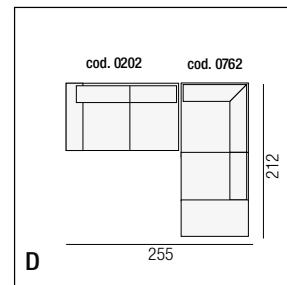
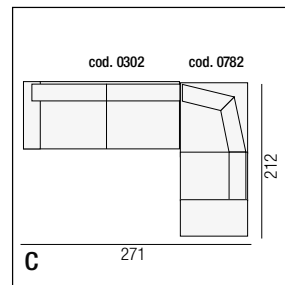
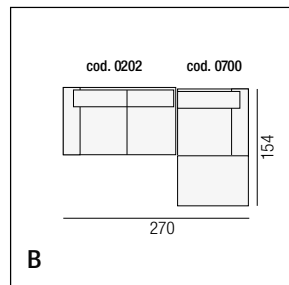
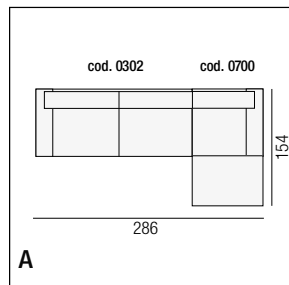
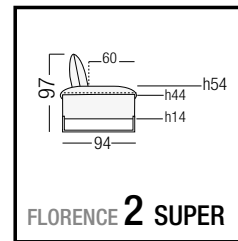
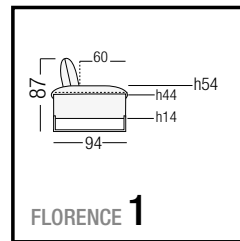
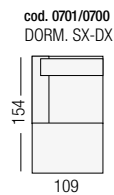
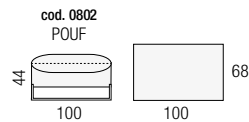
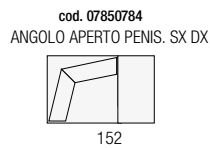
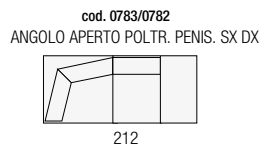
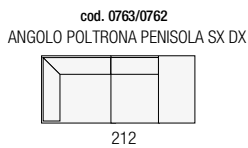
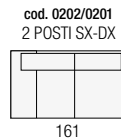
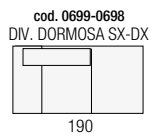
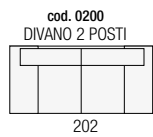
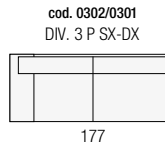
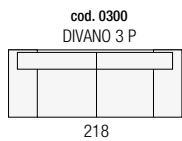
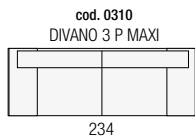

RIVESTIMENTO Pelle o microfibra non sfoderabile. Per le caratteristiche del rivestimento e della manutenzione vedere relative schede tecniche.

IMBOTTITURA Cuscini di seduta, braccioli, poggiatesta e spalliere poggiatesta reclinabili sono realizzate in poliuretano espanso a densità differenziate. Tutte le parti sopraelencate sono ricoperte da una termofalda di dacron autoestinguente. Cuscini di seduta: strato superiore: densità 30 SS (30 kg/mc.) Strato inferiore: densità 30 SC (30 kg/mc.) Termofalda da 350 gr/mq. Braccioli : densità 30 kg/mc. Termofalda da 350 gr/mq. Poggiatesta : densità 23 kg/mc. Termofalda da 350 gr/mq. Spalliere poggiatesta: densità 30 kg/mc. Termofalda da 350 gr/mq. Imbottiture di completamento: densità 21 kg/mc.

PIEDI In legno tinto wengè con profilo cromato, H: cm 4

STRUTTURA Realizzata in legno abbinato a particelle di legno grezzo biodegradabile e pannelli di fibra di legno duro.

NOTE Nella variante relax il modello è realizzato con meccanismo combinato con movimento schienale poggiatesta. Disponibile esclusivamente in versione con motore elettrico con comando posizionato sul lato esterno del divano. L'elemento relax è sempre staccato da quello fisso e viene agganciato con apposito sistema a baionetta. Gli schienali sono dotati di meccanismo manuale a cricchetto, reclinabili a seconda del comfort desiderato.

NOTE SU RIVESTIMENTO La variante con cucitura in cordoncino è possibile solo su rivestimento in pelle cat.B e cat.C

COVERING Leather, microfiber or fabric. Not removable.

PADDING Seat cushion, armrest, kidney rest and adjustable headrest: double density polyurethane foam covered with a Dacron layer.

Seat cushion: upper part: 30kg/m3 "soft comfort". Bottom part: 30 kg/m3 "hard comfort". Dacron layer: 350 gr/m2

Armrest: 30 kg/m3. Upper part: 30 kg/m3. Dacron layer: 350 gr/m2. Kidney rest: 23 kg/m3. Dacron layer 350 gr/m2. Adjustable headrest: 30 kg/m3. Dacron layer: 350 gr/m2

FEET Wengé feet with chromium-plated profile, h 4 cm.

FRAME Hard wood combined with plywood and particle board covered with a Dacron layer.

NOTE Model equipped with adjustable headrest.

Thick thread stitching available only with leather cat.B and cat.C

REVEITEMENT Cuir ou microfibre non déhoussable.

REMBOURRAGE Coussins d'assise, cale-reins, accoudoirs et appui-tête réclinables réalisés en polyuréthane écologique à double densité recouvert avec une couche de dacron.

Assise: Partie inferieure: 30 Kg/m3 (rigide). Partie superieure 30 Kg/m3 (souple). Couche de dacron 350 gr/m2. Accoudoirs: densité 30 Kg/m3. Dacron 350 gr/m2.

Cale-reins: 23 Kg/m3. Dacron 350 gr/m2. Appui-tête: 30 Kg/m3. Dacron 350 gr/m2. Rembourrage de complement: 21 Kg/m3

PIEDS En bois wengé avec profil chromé, h 4 cm.

STRUCTURE En bois massif, multiplis et particules habillés d'une couche de dacron.

NOTE Les dossiers sont équipés d'un mecanisme manuel au niveau des appui-tête, réclinables selon le confort désiré.

Couture avec fil epais disponible seulement sur les cuirs cat. B et C

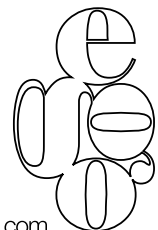
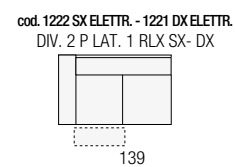
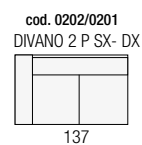
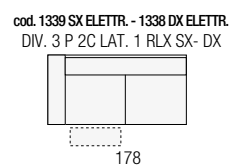
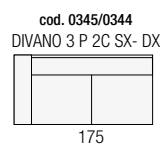
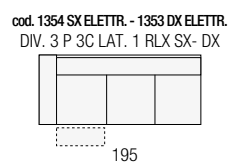
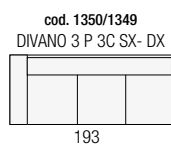
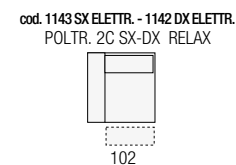
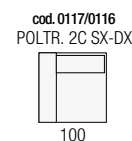
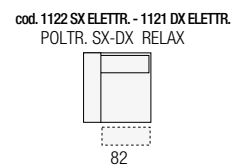
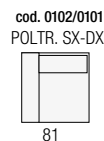
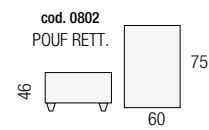
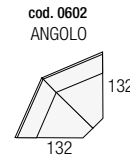
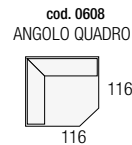
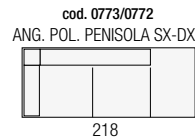
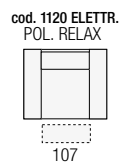
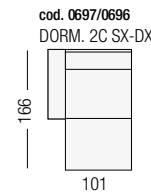
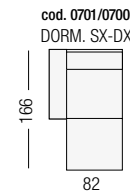
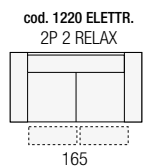
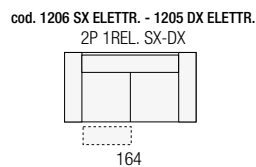
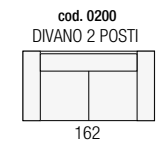
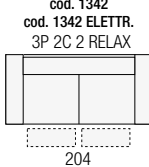
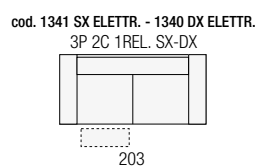
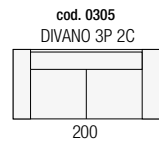
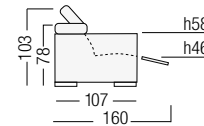
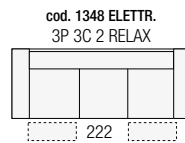
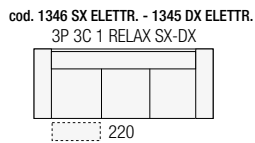
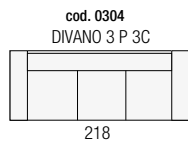

RIVESTIMENTO Pelle o microfibra non sfoderabile. Per le caratteristiche del rivestimento e della manutenzione vedere relative schede tecniche.

IMBOTTITURA Cuscini di seduta, braccioli, poggiatesta e spalliere poggiatesta reclinabili sono realizzate in poliuretano espanso a densità differenziate. Tutte le parti sopraelencate sono ricoperte da una termofalda di dacron autoestinguente. Cuscini di seduta: strato superiore: densità 30 SS (30 kg/mc.) Strato inferiore: densità 30 SC (30 kg/mc.) Termofalda da 350 gr/mq. Braccioli : densità 30 kg/mc. Termofalda da 350 gr/mq. Poggiatesta : densità 23 kg/mc. Termofalda da 350 gr/mq. Spalliere poggiatesta: densità 30 kg/mc. Termofalda da 350 gr/mq. Imbottiture di completamento: densità 21 kg/mc.

PIEDI In legno tinto wengè, H : cm 4

STRUTTURA Realizzata in legno abbinato a particelle di legno grezzo biodegradabile e pannelli di fibra di legno duro.

NOTE Gli schienali sono dotati di meccanismo manuale a cricchetto, reclinabili a seconda del comfort desiderato.

COVERING Leather, microfiber or fabric. Not removable.

PADDING Seat cushion, armrest, kidney rest and adjustable headrest: double density polyurethane foam covered with a Dacron layer. Seat cushion: upper part: 30kg/m³ "soft comfort". Bottom part: 30 kg/m³ "hard comfort". Dacron layer: 350 gr/m² Armrest: 30 kg/m³. Upper part: 30 kg/m³. Dacron layer: 350 gr/m². Kidney rest: 23 kg/m³. Dacron layer 350 gr/m². Adjustable headrest: 30 kg/m³. Dacron layer: 350 gr/m²

FEET Wengé feet with chromium-plated profile, h 4 cm.

FRAME Hard wood combined with plywood and particle board covered with a Dacron layer.

NOTE Model equipped with adjustable headrest.

REVEITEMENT Cuir ou microfibre non déhoussable.

REMBOURRAGE Coussins d'assise, cale-reins, accoudoirs et appuie-tête réclinables réalisés en polyuréthane écologique à double densité recouvert avec une couche de dacron.

Assise: Partie inferieure: 30 Kg/m³ (rigide). Partie superieure 30 Kg/m³ (souple). Couche de dacron 350 gr/m². Accoudoirs: densità 30 Kg/m³. Dacron 350 gr/m².

Cale-reins: 23 Kg/m³. Dacron 350 gr/m². Appuie-tête: 30 Kg/m³. Dacron 350 gr/m². Rembourrage de complement: 21 Kg/m³

PIEDS En bois wengé avec profil chromé, h 4 cm.

STRUCTURE En bois massif, multiplis et particules habillés d'une couche de dacron.

NOTE Les dossiers sont équipés d'un mecanisme manuel au niveau des appuie-tête, réclinables selon le confort désiré.

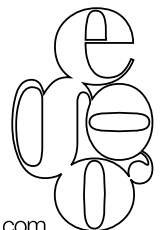
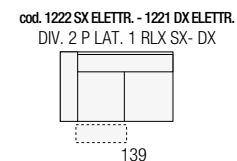
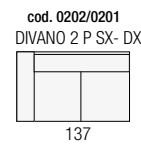
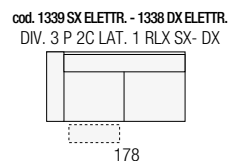
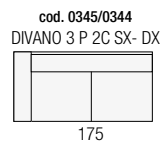
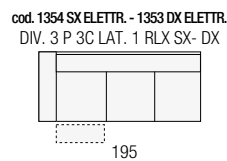
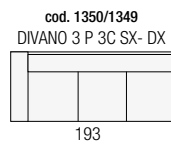
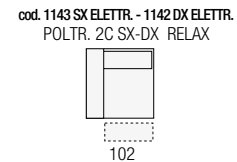
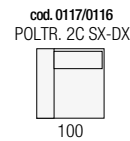
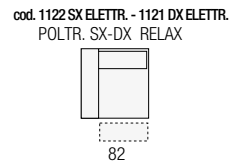
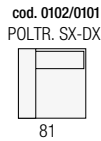
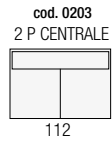
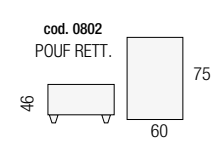
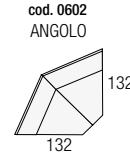
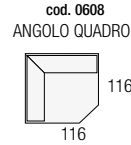
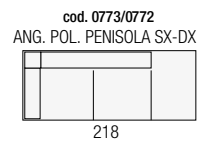
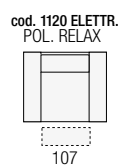
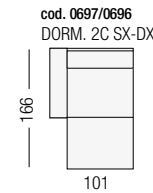
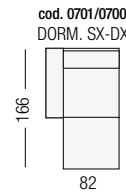
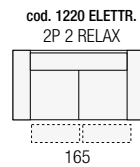
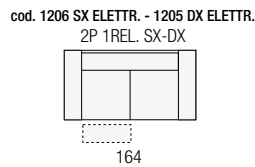
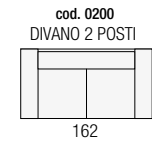
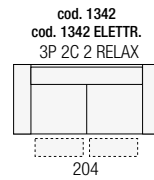
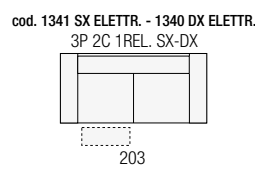
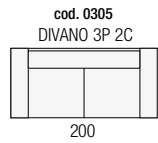
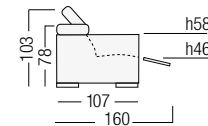
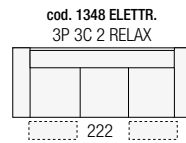
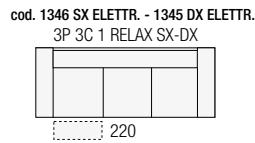
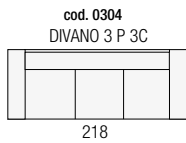

STRUTTURA Realizzata in legno abbinato a particelle di legno grezzo biodegradabile e pannelli di fibra di legno duro.

IMBOTTITURE Cuscini di seduta, poggiatesta e spalliere poggiatesta reclinabili sono realizzate in poliuretano espanso a densità differenziate ricoperte da un materassino realizzato in piuma d'oca.

Cuscini di seduta: strato superiore: densità 30 kg/mc. Strato inferiore: densità 35 kg/mc.

poggiatesta: densità 30 kg/mc.

Spalliere poggiatesta: densità 30 kg/mc.

Imbottiture di completamento: densità 21 kg/mc.

RIVESTIMENTO Pelle o microfibra non sfoderabile. Per le caratteristiche del rivestimento e della manutenzione vedere relative schede tecniche.

PIEDI Struttura "a ponte" in acciaio inox lucidato, H alla base del divano: cm 11.

NOTE I cuscini di seduta ed i poggiatesta sono removibili e si fissano sul divano tramite cerniere. Negli schienali è applicato un meccanismo manuale che permette di alzare le testiere per ottenere un maggiore comfort.

FRAME Hard wood combined with plywood and particle board covered with a dacron layer.

PADDING Seat cushion, kidney rest and headrest: double density polyurethane foam covered with down feather.

Seat cushion: bottom part 35kg/m3, upper part 30kg/m3

Headrest and kidney rest: 30kg/m3

COVERING Leather, microfiber or fabric. Not removable

FEET Stainless steel "bridge-shaped" structure. Height: 11 cm.

NOTE Removable seat cushion and kidney rest equipped with a zip-fastener.

REVETEMENT Cuir ou microfibre non déhoussable.

REMBOURRAGE Coussins d'assise, cale-reins et appuie-tête réclinables réalisés en polyuréthane écologique à double densité recouvert d'un matelas en plumes d'oie.

Coussins d'assise: Partie supérieure 30 Kg/m3. Partie inférieure: 35 Kg/m3.

Cale-reins: 30 Kg/m3.

Appuie-tête: 30 Kg/m3.

Rembourrage de complement: 21 Kg/m3

PIED Structure "pont" en acier inox brillant, base du canapé H: 11 cm.

STRUCTURE En bois massif, multiplis et particules habillés d'une couche de dacron.

NOTE Les coussins d'assise et cale-reins sont amovibles et sont fixés sur le canapé par des fermetures éclair.

Les dossiers sont équipés d'un mécanisme manuel au niveau des appuie-tête, réclinables selon le confort désiré.

cod. 0430

DIVANO 3 POSTI GRANDE

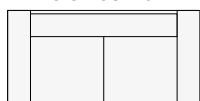

246

cod. 0300

DIVANO 3 POSTI



230

cod. 0302/0301

DIVANO 3 P LAT. SX-DX

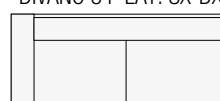

196

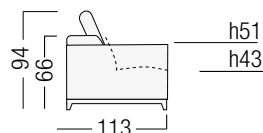

cod. 0200

DIVANO 2 POSTI

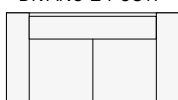

200

cod. 0202/0201

2 POSTI SX-DX

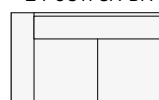

166

cod. 0229

DIVANO 2 POSTI MINI

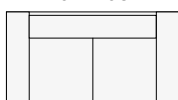

180

cod. 0100

POLTRONA

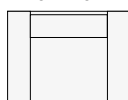

127

cod. 0113
POLTR. MAXI
CENTRALE



81

cod. 0103
POLTR.
CENTRALE



66

cod. 0773/0772

ANG. POL. PENISOLA SX-DX

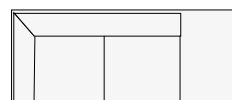

235

cod. 0701/0700
DORM. SX-DX

cod. 0705/0704
DORM. MAXI SX-DX

cod. 0602
ANGOLO

cod. 0802

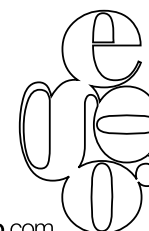

STRUTTURA Realizzata in legno abbinato a particelle di legno grezzo biodegradabile e pannelli di fibra di legno duro.

IMBOTTITURE Cuscini di seduta, braccioli, poggiatesta e spalliere poggiatesta reclinabili sono realizzate in poliuretano espanso a densità differenziate. Tutte le parti sopraelencate sono ricoperte da una termofalda di dacron autoestinguente.

Cuscini di seduta: strato superiore: densità 30 kg/mc. Strato inferiore: densità 35 kg/mc, rivestiti con falda di dacron in fibra di poliestere da 100 gr/mq.

Braccioli e poggiatesta: densità 30 kg/mc. Termofalda di dacron in fibra di poliestere da 450 gr/mq.

Spalliere poggiatesta: densità 23 kg/mc. Termofalda di dacron in fibra di poliestere da 450 gr/mq.

Imbottiture di completamento: densità 21 kg/mc.

RIVESTIMENTO Pelle o microfibra non sfoderabile. Per le caratteristiche del rivestimento e della manutenzione vedere relative schede tecniche.

PIEDI In legno massello tinto wengé con profilo cromato. H = cm 4

NOTE Nella versione relax il modello è dotato esclusivamente di meccanismo elettrico con comando posizionato sul lato esterno del divano, mentre le sedute centrali sono dotate di un pratico telecomando. I comandi possono agire indipendentemente tra di loro variando solo l'inclinazione della testiera oppure permettendo di distendere solo le gambe offrendo infinite possibilità di comfort. Gli elementi relax sono sempre staccati da quelli fissi e vengono agganciati con apposito sistema a baionetta. Nelle versioni fisse senza meccanismo relax in ogni caso è presente il cricchetto manuale nelle testiere.

COVERING Leather, microfiber or fabric. Not removable.

PADDING Seat cushion, armrest, kidney rest and headrest: double density polyurethane foam covered with a Dacron layer.

Seat cushion: upper part: 30kg/m3 "soft comfort". Bottom part: 35 kg/m3 "normal comfort". Dacron layer: 100 gr/m2

Armrest and kidney rest: 30kg/m3. Dacron layer: 450 gr/m2

Headrest: 23 kg/m3. Dacron layer 450 gr/m2

FRAME Hard wood combined with plywood and particle board covered with a Dacron layer.

FEET Wenge' wood with chromium-plated profile. Height 4 cm

NOTE Model equipped with "double motor" electric recliner mechanism for an independent movement of the backrest and the foot rest. Fixed versions are always equipped with manually adjustable headrest.

STRUCTURE En bois massif, multiplis et particules habillés d'une couche de dacron.

REMBOURRAGE Coussins d'assise, cale-reins, accoudoirs et appuie-tête réclinables réalisés en polyuréthane écologique à double densité recouvert avec une couche de dacron.

Coussins d'assise: Partie supérieure 30 Kg/m3. Partie inférieure: 35 Kg/m3. Recouvert d'une couche de Dacron 100gr/m2

Accoudoirs et cale-reins: densité 30 Kg/m3. Dacron 450 gr/m2

Appuie-tête: densité 23 Kg/m3. Dacron 450 gr/m2

Rembourrage de complément: densité 21 Kg/m3

REVETEMENT Cuir ou microfibre non déhoussable.

PIEDS En bois massif teinté wengé avec profil chromé, h 4 cm

NOTE La version est exclusivement relax électrique, actionnable avec commande électrique positionnée sur le coté externe de l'accoudoir, le relax central est quand à lui doté d'une télécommande. Les commandes peuvent agir indépendamment les uns des autres, variant seulement l'inclinaison de l'appuie-tête ou bien permettant d'étendre les jambes, offrant de nombreuses possibilités pour le confort.

L'élément relax est toujours détaché du fixe et est attaché à ce dernier par un système spécifique à baïonnette.

L'élément fixe sans relax est doté de mécanisme manuel au niveau des appuie-tête.

VERSIONI CON MECCANISMO RELAX AZIONABILE SOLO ELETTRICAMENTE.

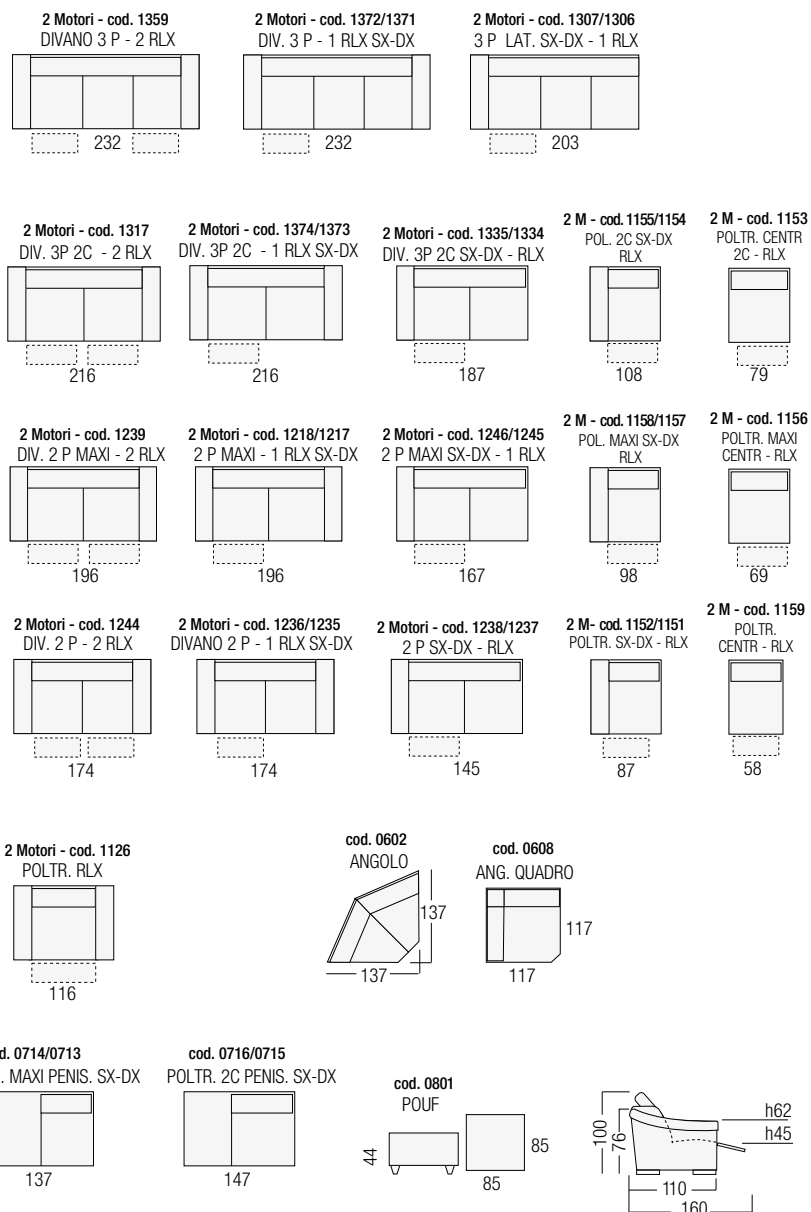
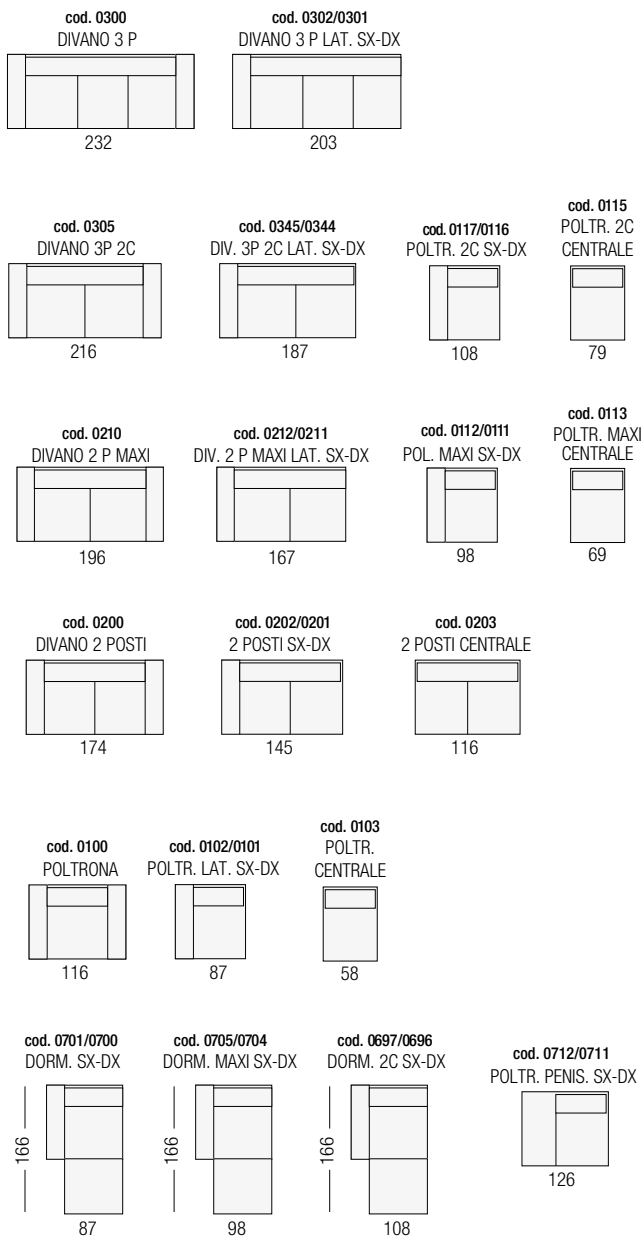

DESIGN Arch. Giulio Manzoni

STRUTTURA Realizzata in legno abbinato a particelle di legno grezzo biodegradabile e pannelli di fibra di legno duro. Le strutture del bracciolo e delle basi delle sedute girevoli sono realizzate in acciaio verniciato.

IMBOTTITURE Cuscini di seduta, braccioli, schienali e poggiatesta reclinabili sono realizzati in poliuretano espanso a densità differenziate. Tutte le parti sopraelencate sono ricoperte da una termofalda di dacron autoestinguente. Cuscini di seduta: strato superiore: densità 30 kg/mc. Strato inferiore: densità 35 kg/mc. Termofalda da 350 gr/mq.

Braccioli: densità 30 kg/mc. Termofalda da 350 gr/mq.

Schienali e poggiatesta: densità 23 kg/mc con rinforzi laterali da 30 kg/mc.

Termofalda da 350 gr/mq.

Imbottiture di completamento: densità 21 kg/mc.

RIVESTIMENTO Pelle o microfibra non sfoderabile. Per le caratteristiche del rivestimento e della manutenzione vedere relative schede tecniche.

PIEDI In alluminio satinato con parte terminale in plexiglass da cm. 7,5

Le sedute girevoli sono corredate di rotelle in metallo ed ABS.

NOTE Gli elementi modulari danno la possibilità di creare composizioni variabili nelle dimensioni a seconda degli spazi. Il sedile della poltrona laterale, inoltre, ruota di 90°, dando la possibilità di usare la seduta come una comoda chaise longue. Gli schienali sono dotati di meccanismo manuale a cricchetto, reclinabili a seconda del comfort desiderato.

DESIGN Architect Giulio Manzoni

FRAME Hard wood combined with plywood and particle board covered with a dacron layer. Armrest structure and spinning seat structure made of painted stainless steel

PADDING Seat cushion, armrest, backrest and headrest: double density polyurethane foam covered with a Dacron layer.

Seat cushion: bottom part 35kg/m3, upper part 30kg/m3. Dacron layer 350gr/m2

Armrest: 30kg/m3. Dacron layer 350gr/m2

Backrest and headrest: 23kg/m3 with strengthened 30kg/m3. sides. Dacron layer 350gr/m2

COVERING Leather, microfiber or fabric. Not removable

FEET Plexiglas and aluminium feet. Height: 7,5 cm

Spinning seat equipped with ABS plastic and metal wheels

NOTE Rhf/lhf armchair is a spinning seat which becomes a chaiselongue

Backrest always equipped with adjustable headrest

DESIGN Arch. Giulio Manzoni

STRUCTURE En bois massif, multiplis et particules habillés d'une couche de dacron. Les structures de l'accoudoir et de la base des assises pivotantes sont réalisées en acier vernis.

REMBOURRAGE Coussins d'assise, accoudoirs, dossiers et appuie-tête réclinables réalisés en polyuréthane écologique à double densité recouvert avec une couche de dacron.

Assise: Partie supérieure 30 Kg/m3. Partie inférieure: 35 Kg/m3. Couche de Dacron 350gr/m2

Accoudoirs: densité 30 Kg/m3. Dacron 350 gr/m2

Dossiers et Appuie-tête: densité 23 Kg/m3 avec renforts lateraux 30Kg/m3.

Dacron 350 gr/m2

Rembourrage de complément: densité 21 Kg/m3

RETEVEMENT Cuir ou microfibre non déhoussable.

PIEDS En aluminium satiné et plexiglass. H 7,5 cm.

Les assises pivotantes sont dotées de roulettes en métal et ABS.

NOTE Les éléments modulaires offrent la possibilité de créer des compositions variables en taille selon l'espace. L'assise du siège latéral pivote de 90°, donnant la possibilité d'utiliser l'assise comme confortable chaise longue. Les dossiers sont équipés d'un mécanisme manuel au niveau des appuie-têtes, réclinables selon le confort désiré.

cod. 0128/0127
POLTRONA LAT.
SX-DX GIREV.

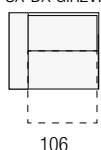

cod. 0103
POLTR.
CENTRALE

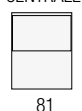

cod. 0113
POLTR.
CENTRALE MAXI

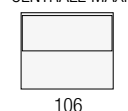

cod. 0701/0700
DORMOSA SX-DX

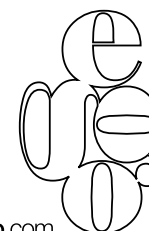
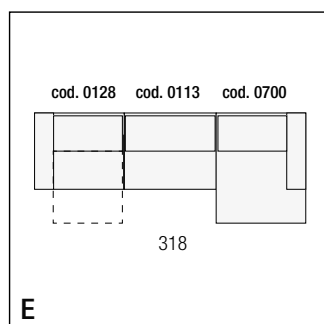
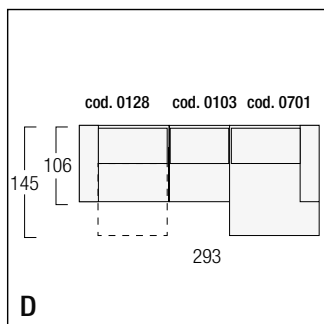
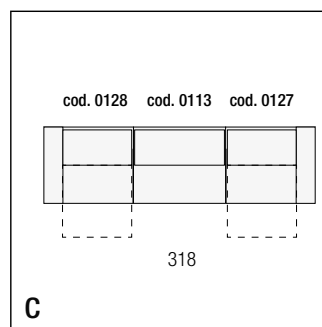
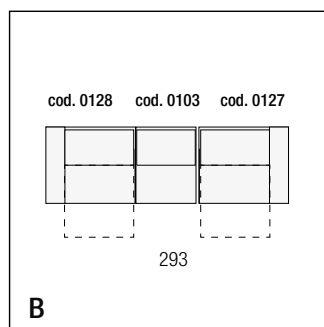
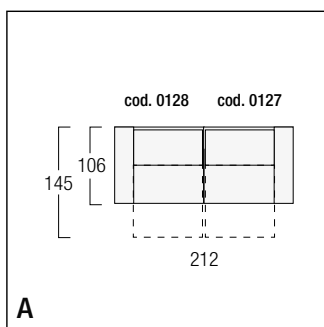
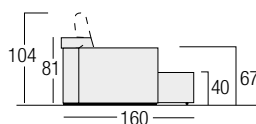
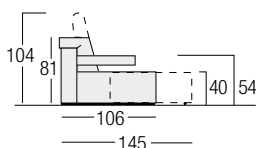
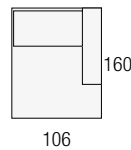

RIVESTIMENTO In pelle e microfibra non sfoderabile. Per le caratteristiche del rivestimento e la manutenzione vedere relative schede tecniche.

IMBOTTITURA Schienali e braccioli realizzati con poliuretano espanso di densità 25 kg/mc ricoperti di dacron resinato autoestinguente. Cuscini di seduta realizzati in poliuretano espanso di densità 35 kg/mc, ricoperti con falda di dacron resinato autoestinguente da 350 gr/mq.

STRUTTURA Realizzata in legno abbinato a particelle di legno grezzo biodegradabile e pannelli di fibra di legno duro.

VERSIONE RLX Realizzato con meccanismo combinato con movimento schienale e poggiatesta. Disponibile sia manuale che elettrico con comando posizionato sul bracciolo laterale.

NOTE Il modello può essere realizzato in due versioni: fisso con cricchetto poggiatesta e RLX con cricchetto poggiatesta.

COVERING Leather, microfiber or fabric. Not removable.

PADDING Ecologic polyurethane foam. Armrest and backrest cushion 25 kg/m3 covered with a Dacron layer. Seat cushion 35 kg/m3 covered with a Dacron layer 350gr/m2.

FRAME Hard wood combined with plywood and particle board covered with a dacron layer.

NOTE Model equipped with adjustable headrest. Corner version not available with adjustable headrest.

Manual or electric recliner available.

REVÊTEMENT Cuir, microfibre ou tissu non déhoussable.

REMBOURRAGE Dossier et accoudoir en polyuréthane écologique densité 25 kg/mc habillé d'un couche de dacron. Assise en polyuréthane écologique densité 35 kg/mc habillé d'un couche de dacron densité 350 gr/m2.

STRUCTURE En bois massif, multiplis et particules habillés d'un couche de dacron.

NOTE Modèle équipé avec tête réglable. Mécanisme relax manuel ou électrique disponible.

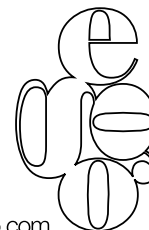
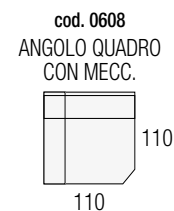
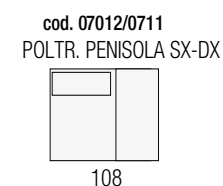
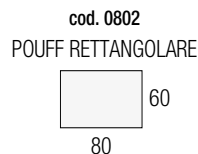
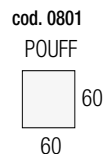
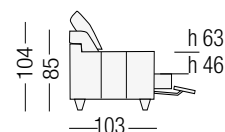
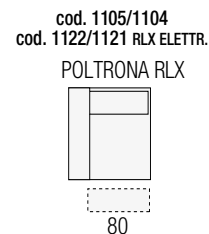
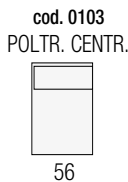
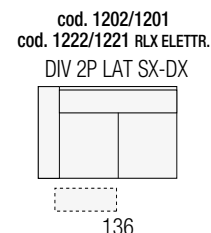
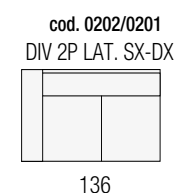
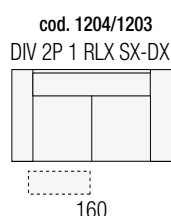
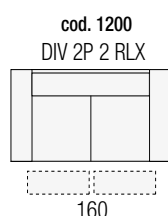
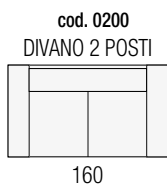
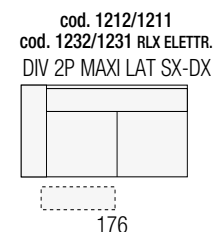
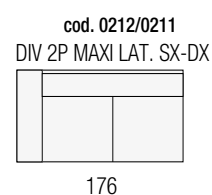
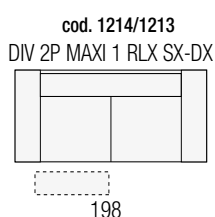
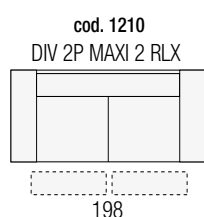
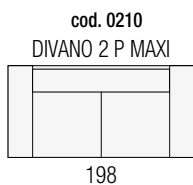
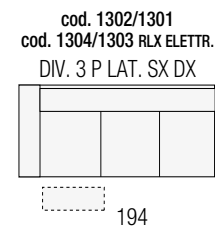
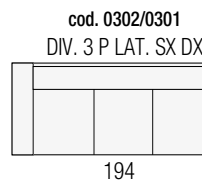
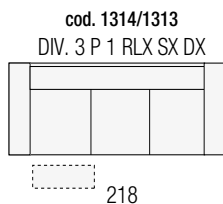
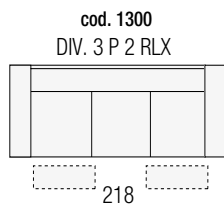
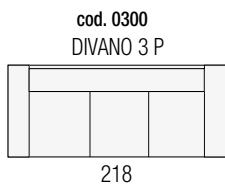

STRUTTURA Realizzata in legno abbinato a particelle di legno grezzo biodegradabile e pannelli di fibra di legno duro.

IMBOTTITURE Cuscini di seduta, braccioli e schienali sono realizzati in poliuretano espanso a densità differenziate. Tutte le parti sopraelencate sono ricoperte da una termofalda di dacron autoestinguente.

Cuscini di seduta: densità 30 SC e 30 NC kg/mc. Termofalda da 350 gr/mq.

Schienali: densità 30 SS e 30 SC kg/mc. Termofalda da 450 gr/mq.

Imbottiture di completamento: densità 21 kg/mc.

RIVESTIMENTO Pelle o microfibra non sfoderabile. Per le caratteristiche del rivestimento e della manutenzione vedere relative schede tecniche.

BASE la poltroncina poggia su una base girevole realizzata in acciaio lucido e misura cm 17 in altezza e cm 58 di diametro. E' possibile richiedere la base realizzata con finitura in vernici a polvere epossidica, nei colori bianco perla, grigio ombra o marrone scuro.

NOTE Gli schienali sono dotati di meccanismo manuale a cricchetto, reclinabili a seconda del comfort desiderato.

La poltrone è inoltre disponibile corredata da braccioli in metallo con finitura assortita a quella della base girevole.

FRAME Hardwood combined with plywood and particle board.

PADDING In polyurethane foam with double density, covered by a Dacron layer. Seat cushions in polyurethane foam 30 SC and 30 NC kg/m3. Covered in Dacron 350 gr/m2.

Back cushion in polyurethane foam 30 SC and 30 NC kg/m3. Covered in Dacron 450 gr/m2.

Frame padding: 21 kg/m3

COVERING Leather or microfiber. Not removable. Please check covering details for care instructions.

BASE Swivel base in shiny stainless steel H17 cm and 58 cm diameter. Also available in epoxy powder finish, colour pearl white, shadow grey o dark brown.

NOTE Backrests come with adjustable headrest mechanism. Altea is also available with metal armrests, having the same finish as the base.

STRUCTURE En bois, multiples et particules habillés d'une couche de dacron.

REMBOURRAGE Les rembourrages sont réalisés en polyuréthane expansé avec densité différenciée. Les mousses sont couvertes par une couche de dacron ouatiné.

Coussins d'assise en polyuréthane expansé densité 30 SC et 30 NC kg/m3. Dacron 350 gr/m2

Coussin de dossier en polyuréthane expansé densité 30 SS et 30 NC kg/m3. Dacron 450 gr/m2.

Rembourrage de complément : densité 21 kg/m3.

REVETEMENT Cuir ou microfibre non déhoussable. Pour les caractéristique du revêtement aussi bien que pour l'entretien veuillez consulter la fiches techniques appropriés.

BASE Base pivotante en acier brillant ayant 17 cm de hauteur et 58 cm de diamètre. Il est aussi disponible en acier peint aux vernis époxy au four coloris blanc perle, gris ombre ou marron foncé.

NOTE Les dossiers sont équipés de tête manuelle inclinable selon le besoin. Le fauteuil est aussi disponible avec accoudoirs en métal ayant la même finition que la base pivotante

cod. 0123
POLTRONCINA GIREVOLE
CON CRICCHETTO TIRAPELLE

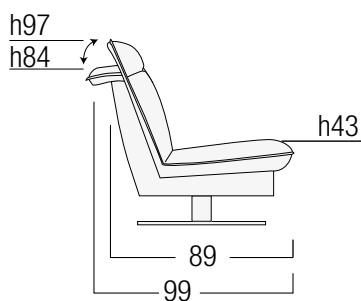
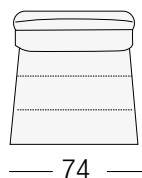

cod. 0122
POLTRONCINA GIREVOLE
CON BRACCIOLI

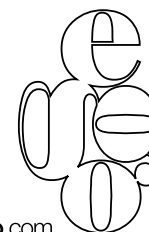
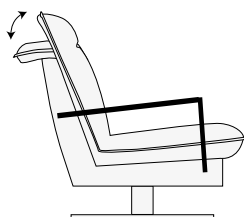
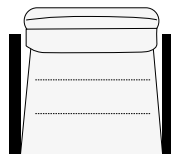

STRUTTURA Realizzata in legno abbinato a particelle di legno grezzo biodegradabile e pannelli di fibra di legno duro.

IMBOTTITURE Cuscini di seduta, braccioli e schienali sono realizzati in poliuretano espanso a densità differenziate. Tutte le parti sopraelencate sono ricoperte da una termofalda di dacron autoestinguente.

Cuscini di seduta: densità 30 SC e 30 NC kg/mc. Termofalda da 350 gr/mq.

Schienali: densità 30 SS e 30 SC kg/mc. Termofalda da 450 gr/mq.

Imbottiture di completamento: densità 21 kg/mc.

RIVESTIMENTO Pelle o microfibra non sfoderabile. Per le caratteristiche del rivestimento e della manutenzione vedere relative schede tecniche.

BASE la poltroncina poggia su una base girevole realizzata in acciaio lucido e misura cm 17 in altezza e cm 58 di diametro. E' possibile richiedere la base realizzata con finitura in vernici a polvere epossidica, nei colori bianco perla, grigio ombra o marrone scuro.

NOTE Gli schienali sono dotati di meccanismo manuale a cricchetto, reclinabili a seconda del comfort desiderato.

La poltrone è inoltre disponibile corredata da braccioli in metallo con finitura assortita a quella della base girevole.

FRAME Hardwood combined with plywood and particle board.

PADDING In polyurethane foam with double density, covered by a Dacron layer.

Seat cushions in polyurethane foam 30 SC and 30 NC kg/m3. Covered in Dacron 350 gr/m2.

Back cushion in polyurethane foam 30 SC and 30 NC kg/m3. Covered in Dacron 450 gr/m2.

Frame padding: 21 kg/m3

COVERING Leather or microfiber. Not removable. Please check covering details for care instructions.

BASE Swivel base in shiny stainless steel H17 cm and 58 cm diameter. Also available in epoxy powder finish, colour pearl white, shadow grey o dark brown.

NOTE Backrests come with adjustable headrest mechanism. Altea is also available with metal armrests, having the same finish as the base.

STRUCTURE En bois, multiples et particules habillés d'une couche de dacron.

REMBOURRAGE Les rembourrages sont réalisés en polyuréthane expansé avec densité différenciée. Les mousses sont couvertes par une couche de dacron ouatiné.

Coussins d'assise en polyuréthane expansé densité 30 SC et 30 NC kg/m3. Dacron 350 gr/m2

Coussin de dossier en polyuréthane expansé densité 30 SS et 30 NC kg/m3. Dacron 450 gr/m2.

Rembourrage de complément : densité 21 kg/m3.

REVETEMENT Cuir ou microfibre non déhoussable. Pour les caractéristique du revêtement aussi bien que pour l'entretien veuillez consulter la fiches techniques appropriés.

BASE Base pivotante en acier brillant ayant 17 cm de hauteur et 58 cm de diamètre. Il est aussi disponible en acier peint aux vernis époxy au four coloris blanc perle, gris ombre ou marron foncé.

NOTE Les dossiers sont équipés de têteère manuelle inclinable selon le besoin. Le fauteuil est aussi disponible avec accoudoirs en métal ayant la même finition que la base pivotante

cod. 0123
POLTRONCINA GIREVOLE
CON CRICCHETTO TIRAPELLE

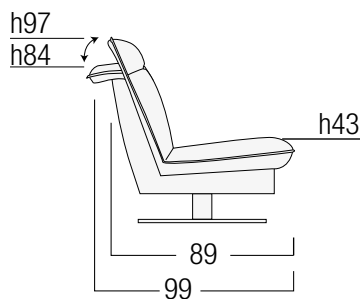
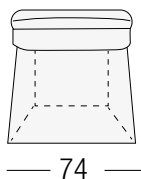

cod. 0122
POLTRONCINA GIREVOLE
CON BRACCIOLI

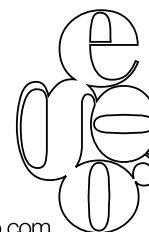
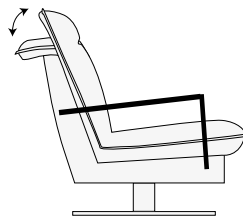
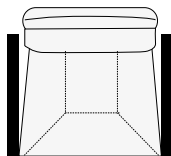

STRUTTURA Realizzata in legno abbinato a particelle di legno grezzo biodegradabile e pannelli di fibra di legno duro.

IMBOTTITURE Cuscino schienale realizzato in poliuretano espanso di densità 30 kg/mc. con zona poggiatesta di densità 23 kg/mc. Cuscino di seduta realizzato in poliuretano espanso di densità 30 kg/mc.

Schienale e seduta sono ricoperti entrambi da una termofalda di dacron autoestinguente da 350 gr/ mq. Le imbottiture di completamento sono realizzate in poliuretano espanso di densità 21 kg/mc.

RIVESTIMENTO Pelle o microfibra non sfoderabile. Per le caratteristiche del rivestimento e della manutenzione vedere relative schede tecniche.

PIEDI In ABS da cm 2.

FRAME Hardwood combined with plywood and particle board.

PADDING Back cushion in polyurethane foam 30 kg/m3, with lumbar support area in foam density 23 kg/mc.

Seat cushions in polyurethane foam 30 kg/m3.

Seat and back cushion covered with dacron layer 350 gr/m2.

Frame padding: 21 kg/m3

COVERING Leather or microfiber. Not removable. Please check covering details for care instructions.

FEET In black ABS- H 2 cm.

STRUCTURE En bois, multiples et particules habillés d'une couche de dacron.

REMBOURRAGE Coussin de dossier en polyuréthane expansé densité 30 kg/m3 avec cales-reins densité 23 kg/m3. Dacron 350 gr/m2.

Coussins d'assise en polyuréthane expansé densité 30 kg/m3. Dacron 350 gr/m2.

Rembourrage de complément : densité 21 kg/m3.

REVETEMENT Cuir ou microfibre non déhoussable. Pour les caractéristique du revêtement aussi bien que pour l'entretien veuillez consulter la fiches techniques appropriés.

PIEDS En ABS noir, H 2 cm.

cod. 0164
POLTRONCINA FISSA

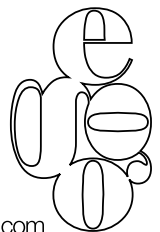
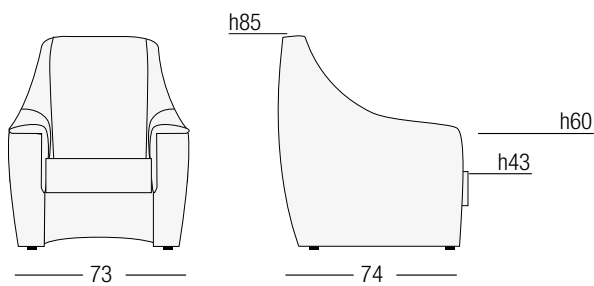

RIVESTIMENTO Pelle o microfibra non sfoderabile. Per le caratteristiche del rivestimento e della manutenzione vedere relative schede tecniche.

IMBOTTITURA Cuscini di seduta, braccioli, poggiatesta e spalliere poggiatesta reclinabili sono realizzate in poliuretano espanso a densità differenziate. Tutte le parti sopraelencate sono ricoperte da una termofalda di dacron autoestinguente. Cuscini di seduta: strato superiore: densità 30 SS (30 kg/mc.) Strato inferiore: densità 30 SC (30 kg/mc.) Termofalda da 350 gr/mq. Braccioli : densità 30 kg/mc. Termofalda da 350 gr/mq. Poggiatesta : densità 23 kg/mc. Termofalda da 350 gr/mq. Spalliere poggiatesta: densità 30 kg/mc. Termofalda da 350 gr/mq. Imbottiture di completamento: densità 21 kg/mc.

PIEDI In legno tinto wengé con profilo cromato, H: cm 4

STRUTTURA Realizzata in legno abbinato a particelle di legno grezzo biodegradabile e pannelli di fibra di legno duro.

NOTE Nella variante relax il modello è realizzato con meccanismo combinato con movimento schienale poggiatesta. Disponibile esclusivamente in versione con motore elettrico con comando posizionato sul lato esterno del divano. L'elemento relax è sempre staccato da quello fisso e viene agganciato con apposito sistema a baionetta. Gli schienali sono dotati di meccanismo manuale a cricchetto, reclinabili a seconda del comfort desiderato.

COVERING Leather, microfiber or fabric. Not removable.

PADDING Seat cushion, armrest, kidney rest and adjustable headrest: double density polyurethane foam covered with a Dacron layer. Seat cushion: upper part: 30kg/m³ "soft comfort". Bottom part: 30 kg/m³ "hard comfort". Dacron layer: 350 gr/m² Armrest: 30 kg/m³. Upper part: 30 kg/m³. Dacron layer: 350 gr/m². Kidney rest: 23 kg/m³. Dacron layer 350 gr/m². Adjustable headrest: 30 kg/m³. Dacron layer: 350 gr/m²

FEET Wengé feet with chromium-plated profile, h 4 cm.

FRAME Hard wood combined with plywood and particle board covered with a Dacron layer.

REVETEMENT Cuir ou microfibre non déhoussable.

REMBOURRAGE Coussins d'assise, cale-reins, accoudoirs et appuie-tête réclinables réalisés en polyuréthane écologique à double densité recouvert avec une couche de dacron.

Assise: Partie inférieure: 30 Kg/m³ (rigide). Partie supérieure 30 Kg/m³ (souple). Couche de dacron 350 gr/m². Accoudoirs: densité 30 Kg/m³. Dacron 350 gr/m². Cale-reins: 23 Kg/m³. Dacron 350 gr/m².

Appuie-tête: 30 Kg/m³. Dacron 350 gr/m². Rembourrage de complement: 21 Kg/m³

PIEDS En bois wengé avec profil chromé, h 4 cm.

STRUCTURE En bois massif, multiplis et particules habillés d'une couche de dacron.

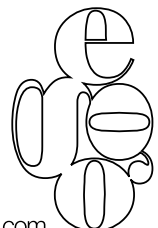
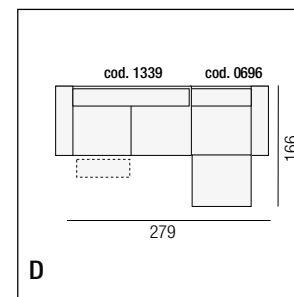
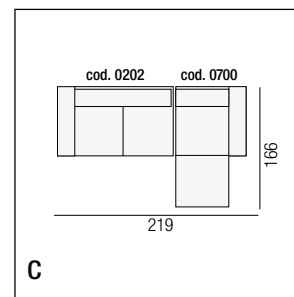
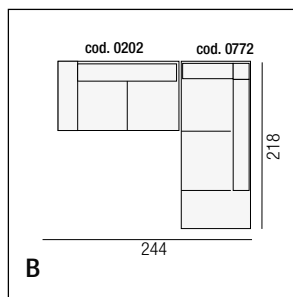
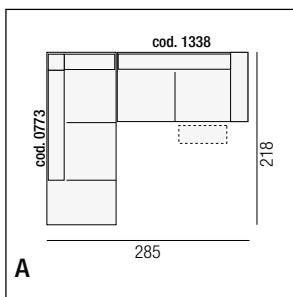
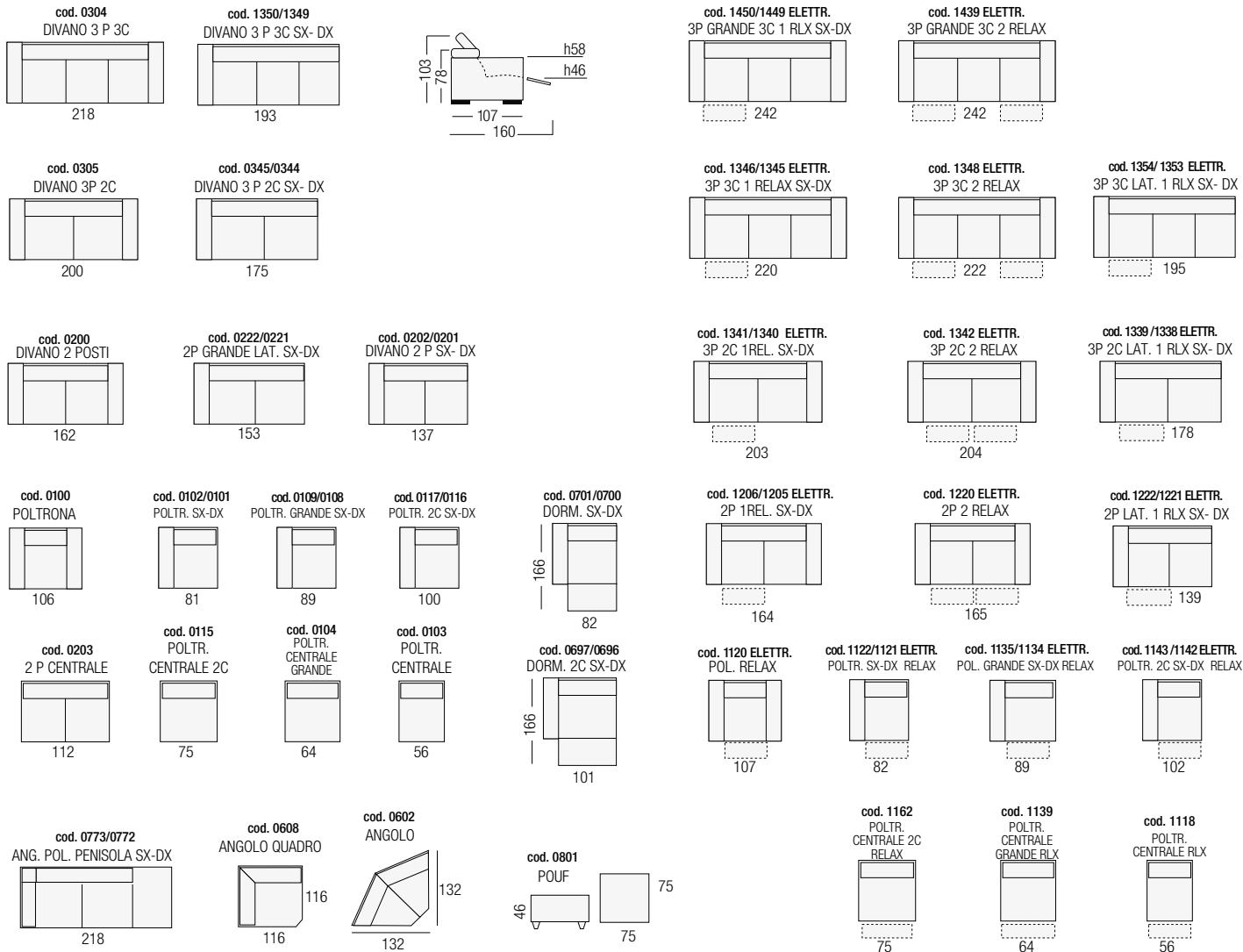

RIVESTIMENTO In pelle e microfibra non sfoderabile. Per le caratteristiche del rivestimento e la manutenzione vedere relative schede tecniche.

IMBOTTITURA Schienali e braccioli realizzati con poliuretano espanso di densità 25 kg/mc ricoperti di dacron resinato autoestinguente. Cuscini di seduta realizzati in poliuretano espanso di densità 35 kg/mc, ricoperti con falda di dacron resinato autoestinguente da 350 gr/mq.

STRUTTURA Realizzata in legno abbinato a particelle di legno grezzo biodegradabile e pannelli di fibra di legno duro.

VERSIONE RLX Realizzato con meccanismo combinato con movimento schienale e poggiatesta. Disponibile sia manuale che elettrico con comando posizionato sul bracciolo laterale.

PIEDE In ABS cromato, L: cm 12, H: cm 4

NOTE Il modello può essere realizzato in due versioni: fisso con cricchetto poggiatesta e RLX con cricchetto poggiatesta.

COVERING Leather, microfiber or fabric. Not removable.

PADDING Ecologic polyurethane foam. Armrest and backrest cushion 25 kg/m3 covered with a Dacron layer. Seat cushion 35 kg/m3 covered with a Dacron layer 350gr/m2.

FRAME Hard wood combined with plywood and particle board covered with a dacron layer.

FEET Chromium-ABS. Height 4cm

NOTE Model equipped with adjustable headrest. Corner version not available with adjustable headrest.

Manual or electric recliner available.

REVÊTEMENT Cuir, microfibre ou tissu non déhoussable.

REMBOURRAGE Dossier et accoudoir en polyuréthane écologique densité 25 kg/mc habillé d'un couche de dacron. Assise en polyuréthane écologique densité 35 kg/mc habillé d'un couche de dacron densité 350 gr/m2.

STRUCTURE En bois massif, multiplis et particules habillés d'un couche de dacron.

PIEDS En ABS chromé. Hauteur 4cm.

NOTE Modèle équipé avec tête réglable. Mécanisme relax manuel ou électrique disponible.

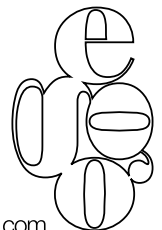
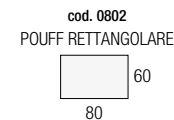
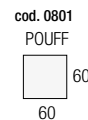
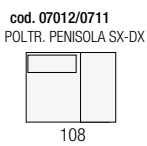
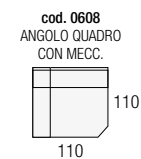
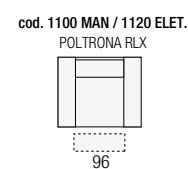
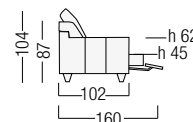
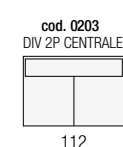
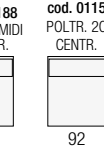
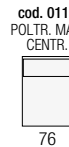
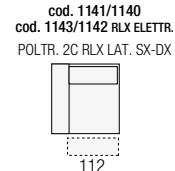
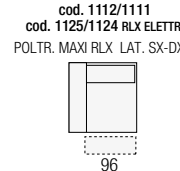
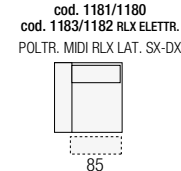
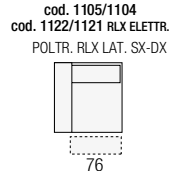
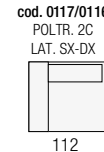
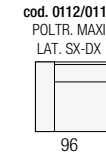
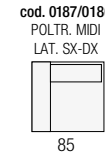
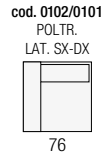
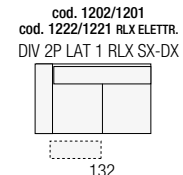
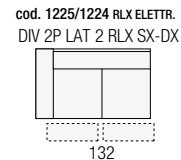
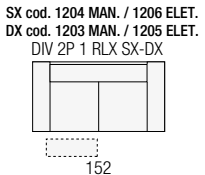
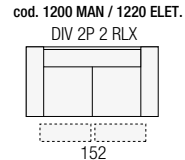
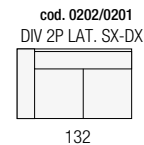
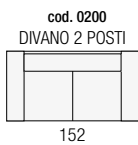
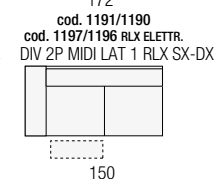
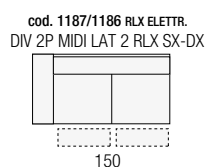
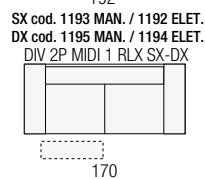
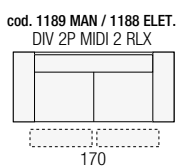
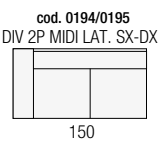
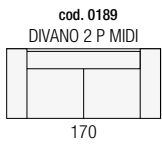
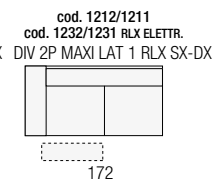
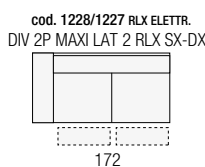
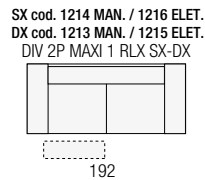
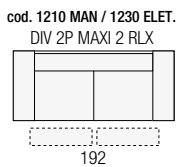
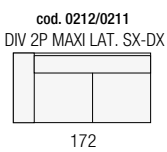
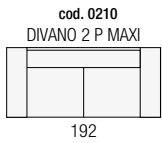
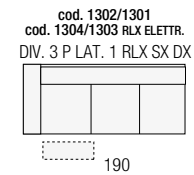
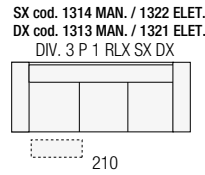
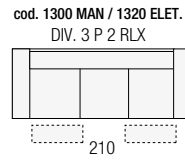
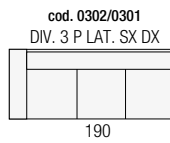
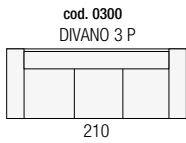
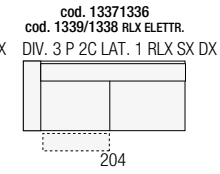
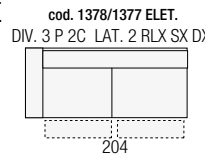
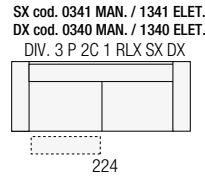
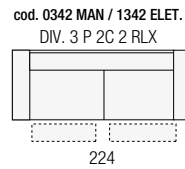
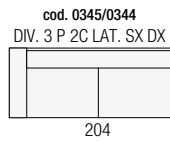
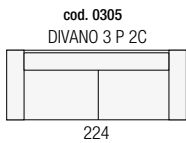

IRIS 1 - IRIS 2

Rev. 10/2013

STRUTTURA Realizzata in legno abbinato a particelle di legno grezzo biodegradabile e pannelli di fibra di legno duro.

IMBOTTITURE Cuscini di seduta, braccioli e schienali con testiere reclinabili sono realizzate in poliuretano espanso a densità differenziate. Tutte le parti sopraelencate sono ricoperte da una termofalda di dacron autoestinguente. Cuscini di seduta: strato superiore: densità 30 kg/mc.(SS) Strato inferiore: densità 30 kg/mc.(NC) Termofalda da 350 gr/mq.

Braccioli: densità 25 kg/mc.(NC) Termofalda da 350 gr/mq.

Schienali con testiere reclinabili: densità 18 kg/mc.(S) con parti laterali realizzate in densità 25 kg/mc. (NC) Termofalda da 350 gr/mq.

Imbottiture di completamento: densità 21 kg/mc.

RIVESTIMENTO Pelle o microfibra non sfoderabile. Per le caratteristiche del rivestimento e della manutenzione vedere relative schede tecniche.

PIEDI In acciaio lucidato, oppure in legno massello di faggio evaporato con finitura noce, noce brunito, wengué oppure verniciato. H cm 12.

NOTE Il modello è dotato di un cricchetto nella testiera che permette di variarne l'inclinazione ed assecondare le più varie esigenze di comfort.

FRAME Hardwood combined with plywood and particle board.

PADDING Seat cushion, armrests, lumbar supports, backrests and headrests are made in polyurethane foam with varying density. All of the above parts are covers with a Dacron layer.

Seat cushions: Upper part: 30 kg/m3 (SS). Bottom part: 30 kg/m3 (NC). Dacron layer 350 gr/m2.

Armrests: 25 kg/m3 (NC). Dacron layer 350 gr/m2.

Backs and headrests: 18 kg/m3 (S) with lateral parts in foam density 25 kg/m3 (NC). Dacron layer 350 gr/m2.

Frame padding: 21 kg/m3

COVERING Leather or microfiber. Not removable. Please check covering details for care instructions.

FEET Shiny metal H 12cm. Also available in wood stained walnut, dark walnut, wengué or colored.

NOTE Headrests are equipped with manual adjustable mechanism.

STRUCTURE En bois, multiples et particules habillés d'une couche de dacron.

REMBOURRAGE Coussins d'assise, accoudoirs, cales-reins, dossiers et appuie-tête en polyuréthane expansé à double densité.

Toutes parties susdites sont recouvertes avec une couche de dacron.

Coussins d'assise: Partie supérieure 30 kg/m3 (SS), partie inférieure 30 kg/m3 (NC). Dacron 350 gr/m2.

Accoudoirs: 25 kg/m3 (NC). Dacron 350 gr/m2.

Dossiers et appuie-tête: 18 kg/m3 (S) et partie latérales en 25 kg/mc (NC). Dacron 350/m2.

Rembourrage de complément: densité 21 kg/m3.

REVELEMENT Cuir ou microfibre non déhoussable. Pour les caractéristique du revêtement aussi bien que pour l'entretien veuillez consulter les fiches techniques appropriés.

PIEDS En métal brillant, H 12cm, ou bien en bois teinté noyer, noyer foncé, wengue ou coloré.

NOTES Les appuie-têtes sont équipé d'une mécanique manuelle à crémaillère.

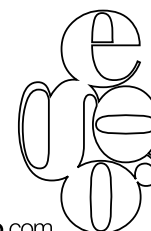
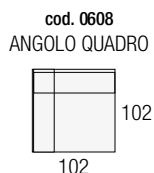
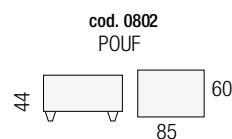
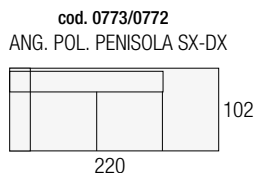
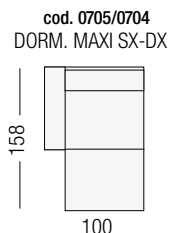
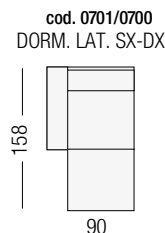
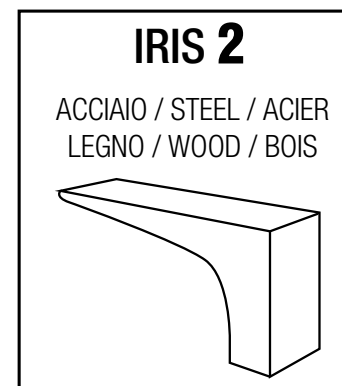
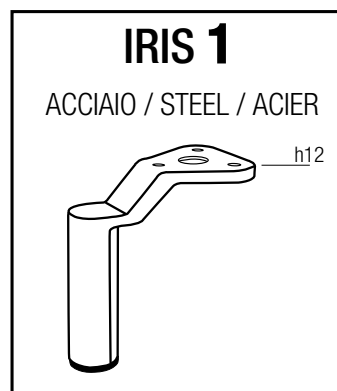
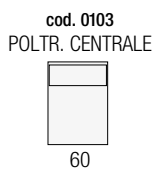
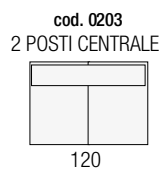
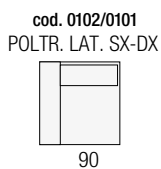
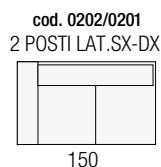
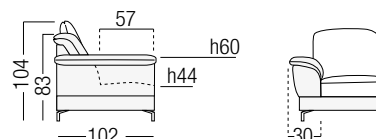
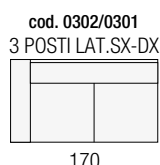
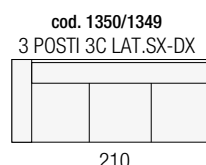
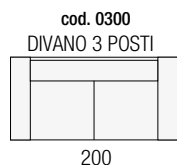

STRUTTURA Realizzata in legno abbinato a particelle di legno grezzo biodegradabile e pannelli di fibra di legno duro.

IMBOTTITURE Cuscino di seduta, braccioli e schienale sono realizzati in poliuretano espanso ecologico a densità differenziate.

Cuscino di seduta a densità differenziata: parte superiore 30 (sc) kg/mc, parte inferiore 30 (nc) kg/mc, ricoperto con una termofalda di dacron autoestinguente da 350 gr/mq.

Braccioli: Realizzati con una lastrina in poliuretano espanso, densità 30 (s) kg/mc ricoperti con dacron resinato da 200 gr/mq.

Cuscino schienale: Realizzato in poliuretano espanso, densità 18 (s) Kg/mc, ricoperto con termofalda di dacron autoestinguente da 350 gr/mq

Imbottiture di completamento: densità 21 kg/mc.

RIVESTIMENTO Pelle o microfibra non sfoderabile. Per le caratteristiche del rivestimento e della manutenzione vedere relative schede tecniche.

PIEDI Il modello può essere corredato da piedi in legno massello di faggio, disponibili nei colori noce, noce brunito, wengué o verniciati, oppure corredato di una base girevole, in metallo verniciato nero. Altezza piedi o base: cm 5.

NOTE Nella versione relax il modello è realizzato con meccanismo combinato con movimento schienale poggipiedi. Disponibile sia manuale che elettrico con comando posizionato sul bracciolo laterale. Il meccanismo elettrico non è

STRUCTURE En bois, multipliés et particules habillés d'une couche de dacron.

REMBOURRAGE Coussins d'assise, accoudoirs, et dossiers en polyuréthane expansé à double densité. Toutes parties susdites sont recouvertes avec une couche de dacron.

Coussins d'assise : Partie supérieure 30 (sc) kg/m3, partie inférieure 30 (nc) kg/m3 portante. Dacron 350 gr/m2.

Accoudoirs: Polyuréthane expansé 30 (s) kg/mc recouvert avec une couche de dacron 200 gr/m2.

Dossiers: Polyuréthane expansé 18 (s) kg/mc recouvert avec une couche de dacron 350 gr/m2.

Rembourrage de complément : densité 21 kg/m3.

REVETEMENT Cuir ou microfibre non déhoussable. Pour les caractéristique du revêtement aussi bien que pour l'entretien veuillez consulter les fiches techniques appropriés.

PIEDS Le modèle peut être réalisé avec pieds bois coloris noyer, noyer foncé ou wengué, ou bien avec base en métal pivotante. Pieds ou base H 5cm.

NOTE En version relax le modèle est réalisé avec mécanique combinée repose pieds/dossiers. Disponible en version manuelle ou électrique avec commande située sur le coté de l'accoudoir. La mécanique électrique n'est pas disponible avec base pivotante.

FRAME Hardwood combined with plywood and particle board.

PADDING Seat cushion, armrests and backrests are made in polyurethane foam with varying density. All of the above parts are covers with a Dacron layer.

Seat cushions: Upper part 30 (sc) kg/m3, bottom part 30 (nc) kg/m3. Dacron layer 350 gr/m2.

Armrests: Polyurethane foam 30 kg/m3. Dacron layer 350 gr/m2.

Backrests: Polyurethane foam 18 (s) kg/m3. Dacron layer 350 gr/m2.

Frame padding: 21 kg/m3

COVERING Leather or microfiber. Not removable. Please check covering details for care instructions.

FEET The model can have wooden feet in walnut, dark walnut or wengue. In alternative swivel metal base. Feet or base height cm 5.

NOTE In the relax version it is made with combined mechanism: footrest-backrest.

Available both manual or electric with controls placed on the armrest side. With the electric mechanism the model is not available with swivel base.

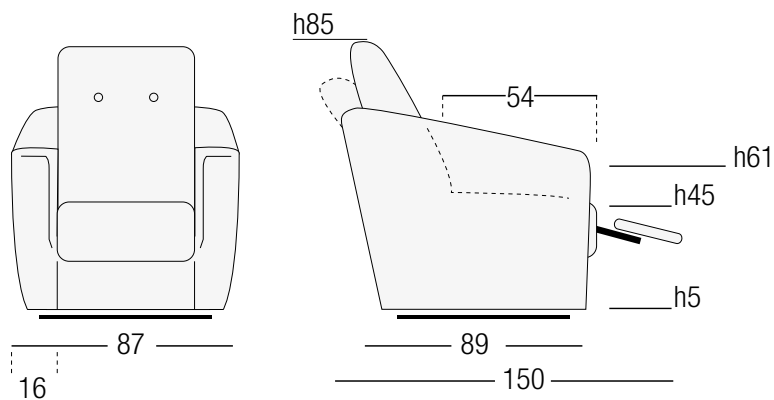

cod. 0164 POLTRONCINA FISSA

cod. 0123 POLTRONCINA GIREVOLE

cod. 0129 POLTRONCINA GIREVOLE / RELAX MANUALE

cod. 0130 POLTRONCINA RELAX MANUALE

cod. 0132 POLTRONCINA RELAX ELETTRICO

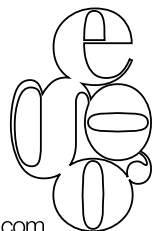

STRUTTURA Realizzata in legno abbinato a particelle di legno grezzo biodegradabile e pannelli di fibra di legno duro.

IMBOTTITURE Cuscini di seduta, braccioli e schienali sono realizzati in poliuretano espanso ecologico a densità differenziate.

Cuscini di seduta a densità differenziata: strato superiore 30 kg/mc (SS), strato inferiore 30 kg/mc (SC), il tutto ricoperto con una termofalda di dacron autoestingente da 350 gr/mq.

Braccioli: densità 30 kg/mc (SS) ricoperti con una termofalda di dacron autoestingente da 450 gr/mq. Le fiancate dei braccioli sono ricoperte da poliuretano espanso di completamento, e rivestite con una falda di dacron resinato da 200 gr/mq.

Cuscini schienali: densità 23 kg/mc (S) ricoperti con una termofalda di dacron autoestingente da 350 gr/mq.

Imbottiture di completamento: densità 21 kg/mc.

RIVESTIMENTO Pelle o microfibra non sfoderabile. Per le caratteristiche del rivestimento e della manutenzione vedere relative schede tecniche.

PIEDI In legno massello di faggio evaporato, tinto con vernici all'acqua ecologiche, nei colori wengè, noce brunito, noce.

NOTE Nella versione relax il modello è realizzato con meccanismo combinato con movimento schienale poggiatesta. Disponibile sia manuale che elettrico con comando posizionato sul bracciolo laterale. L'elemento relax è sempre staccato da quello fisso e viene agganciato con apposito sistema a baionetta.

FRAME Hardwood combined with plywood and particle board.

PADDING Seat cushion, armrests and backrests are made in polyurethane foam with varying density.

Seat cushions: Upper part 30 (ss) kg/m3, bottom part 30 (sc) kg/m3. Dacron layer 350 gr/m2.

Armrests: Polyurethane foam 30 kg/m3 (ss). Dacron layer 450 gr/m2. Armrests sides are covered with complementary polyurethane foam covered with Dacron layer 200 gr/mq.

Backrests: Polyurethane foam 23 (s) kg/m3. Dacron layer 350 gr/m2.

Frame padding: 21 kg/m3

COVERING Leather or microfiber. Not removable. Please check covering details for care instructions.

FEET In beech wood coloured with water based paint in wengué, walnut or dark walnut.

NOTE The relax version it is made with combined mechanism: footrest-backrest. Available both manual or electric with controls placed on the armrest side. The relax equipped part is always delivered separately and connected to the fixed part by made for purpose bayonet fittings.

STRUCTURE En bois, multiples et particules habillées d'une couche de dacron.

REMBOURRAGE Coussins d'assise, accoudoirs, et dossiers en polyuréthane expansé à double densité. Coussins d'assise : Partie supérieure 30 (ss) kg/m3, partie inférieure 30 (sc) kg/m3 portante. Couche en dacron 350 gr/m2.

Accoudoirs: Polyuréthane expansé 30 (ss) kg/mc recouvert avec une couche de dacron 450 gr/m2. Les parties latérales des accoudoirs sont habillées avec polyuréthane de complément et couche de dacron 200 gr/m2.

Dossiers: Polyuréthane expansé 23 (s) kg/mc recouvert avec une couche de dacron 350 gr/m2.

Rembourrage de complément : densité 21 kg/m3.

REVETEMENT Cuir ou microfibre non déhoussable. Pour les caractéristiques du revêtement aussi bien que pour l'entretien veuillez consulter les fiches techniques appropriés.

PIEDS En hêtre massif teinté avec vernis écologiques à base d'eau, dans les coloris wengué, noyer e noyer foncé.

NOTE En version relax le modèle est réalisé avec mécanique combinée repose pieds/dossiers. Disponible en version manuelle ou électrique avec commande située sur le coté de l'accoudoir. L'élément avec relax est toujours séparé des éléments fixes et relié avec un système à baionnette.

cod. 0300
DIV. 3 POSTI

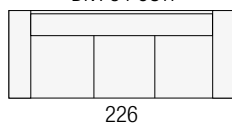

cod. 1300 MAN / 1320 ELET.
DIV. 3 POSTI RLX

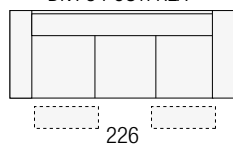

SX cod. 1314 MAN. / 1322 ELET.
DX cod. 1313 MAN. / 1321 ELET.
DIV. 3 POSTI RLX SX DX

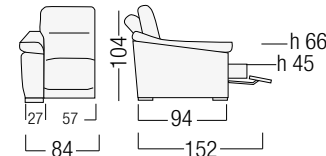
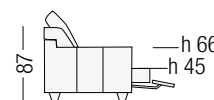
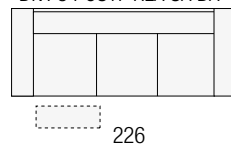

cod. 0305
DIVANO 3 P 2C

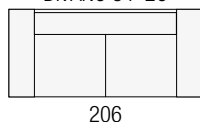

cod. 0342 MAN / 1342 ELET.
DIV. 3 P 2C 2 RLX

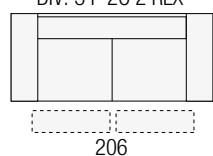

SX cod. 0341 MAN. / 1341 ELET.
DX cod. 0340 MAN. / 1340 ELET.
DIV 3 P 2C 1 RLX SX-DX

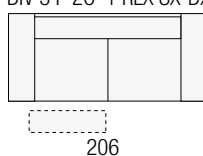

cod. 0200
DIVANO 2 POSTI

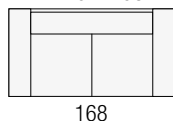

cod. 1200 MAN / 1220 ELET.
DIV 2P 2 RLX

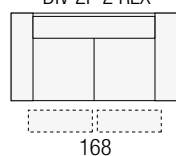

SX cod. 1204 MAN. / 1206 ELET.
DX cod. 1203 MAN. / 1205 ELET.
DIV 2P 1 RLX SX-DX

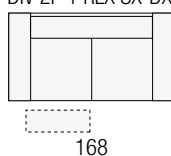

cod. 0100
POLTRONA

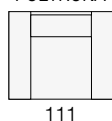

cod. 1100 MAN / 1120 ELET.
POLTRONA RLX

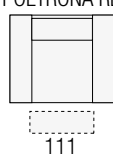

cod. 0802
POUFF
60
80

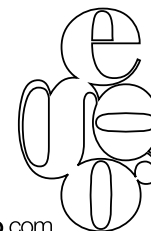
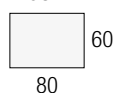

STRUTTURA Realizzata in legno abbinato a particelle di legno grezzo biodegradabile e pannelli di fibra di legno duro.

IMBOTTITURE Cuscini di seduta, braccioli, poggiatesta e spalliere poggiatesta reclinabili sono realizzate in poliuretano espanso. Tutte le parti sopraelencate sono ricoperte da una termofalda di dacron autoestinguente.

Cuscini di seduta a densità differenziata: parte superiore di densità 30 kg/mc soffice, parte inferiore di densità 30 kg/mc portante, ricoperti da una termofalda da 350 gr/mq.

Braccioli: densità 30 kg/mc. Termofalda da 350 gr/mq.

Poggiatesta: densità 25 kg/mc. Termofalda da 350 gr/mq.

Spalliere poggiatesta: densità 25 kg/mc. Termofalda da 350 gr/mq.

Imbottiture di completamento: densità 21 kg/mc.

RIVESTIMENTO Pelle o microfibra non sfoderabile. Per le caratteristiche del rivestimento e della manutenzione vedere relative schede tecniche.

PIEDI In acciaio lucidato oppure in legno massello di faggio evaporato tinto con vernici ecologiche ad acqua, nei colori noce, noce brunito o wengé, oppure verniciati con tinte RAL coordinate con il rivestimento del modello.

NOTE Nella versione relax il modello è dotato esclusivamente di meccanismo elettrico con comando posizionato sul lato esterno del divano, mentre le sedute centrali sono dotate di un pratico telecomando. Gli elementi relax sono sempre staccati da quelli fissi e vengono agganciati con apposito sistema a baionetta. Nelle versioni fisse senza meccanismo relax in ogni caso è presente il cricchetto manuale nelle testiere.

FRAME Hardwood combined with plywood and particle board.

PADDING Seat cushion, armrests, lumbar supports and backrests-headrests are made in polyurethane foam. Every part mentioned is covered by a Dacron layer. Seat cushions with varying density: Upper part 30 kg/m3 soft, bottom part 30 kg/m3 supporting. Dacron layer 350 gr/m2.

Armrests: Polyurethane foam 30 kg/m3. Dacron layer 350 gr/m2.

Lumbar supports: Polyurethane foam 25 kg/m3. Dacron layer 350 gr/m2.

Backrests-headrests: Polyurethane foam 25 kg/m3. Dacron layer 350 gr/m2.

Frame padding: Polyurethane foam 21 kg/m3.

COVERING Leather or microfiber. Not removable. Please check covering details for care instructions.

FEET In polished steel or in beech wood coloured with water based paint in wengé, walnut or dark walnut or in RAL colours combined with the covering.

NOTE The relax version comes with electric movements only. Controls are placed on the armrest side, whilst armless units are equipped with a remote control. Elements with relax mechanism always delivered separately and connected to the fixed parts by made for purpose bayonet fittings. Fixed versions are always equipped with mechanical headrests mechanism.

STRUCTURE En bois, multiples et particules habillés d'une couche de dacron.

REMBOURRAGE Coussins d'assise, accoudoirs, cale reins et dossiers appui-tête en polyuréthane expansé. Toutes les parties indiquées sont couvertes par une couche de dacron. Coussins d'assise à densité différenciée: Partie supérieure 30 kg/m3 souple, partie inférieure 30 kg/m3 portante. Couche en dacron 350 gr/m2. Accoudoirs: Polyuréthane expansé 30 kg/m3 recouvert avec une couche de dacron 350 gr/m2.

Cale reins: Polyuréthane expansé 25 kg/m3 recouvert avec une couche de dacron 350 gr/m2. Dossiers appui-tête: Polyuréthane expansé 25 kg/m3 recouvert avec une couche de dacron 350 gr/m2.

Rembourrage de complément: densité 21 kg/m3.

REVETEMENT Cuir ou microfibre non déhoussable. Pour les caractéristiques du revêtement aussi bien que pour l'entretien veuillez consulter les fiches techniques appropriées.

PIEDS En acier poli ou en hêtre massif teinté avec vernis écologiques à base d'eau, dans les coloris wengés, noyer e noyer foncé ou bien avec des couleurs RAL combinées avec le revêtement.

NOTE En version relax le modèle est réalisé exclusivement avec relax électrique ayant sa commande située sur la partie latérale extérieure de l'accoudoir, alors que les assises centrales sont équipées avec une pratique télécommande. Les éléments avec relax sont toujours séparés des éléments fixes et reliés avec un système à baïonnette. Les versions fixes sans relax sont en tout cas toujours équipées avec mécanique à crémaillère des appui tête.

VERSIONI CON MECCANISMO RELAX AZIONABILE SOLO ELETTRICAMENTE.

<p>cod. 0305 DIVANO 3P 2C 198</p>	<p>cod. 0345/0344 DIV. 3P 2C LAT. SX-DX 178</p>	<p>cod. 0117/0116 POLTR. 2C SX-DX 99</p>	<p>cod. 0115 POLTR. 2C CENTRALE 79</p>	<p>cod. 1342 DIV. 3P 2C - 2 RLX 198</p>	<p>cod. 1341/1340 DIV. 3P 2C - 1 RLX SX-DX 198</p>	<p>cod. 1339/1338 DIV. 3P 2C SX-DX - 1 RLX 178</p>	<p>cod. 1378/1377 DIV. 3P 2C SX-DX - 2 RLX 178</p>	
<p>cod. 0210 DIVANO 2 P MAXI 178</p>	<p>cod. 0212/0211 DIV. 2 P MAXI LAT. SX-DX 158</p>	<p>cod. 0112/0111 POL. MAXI SX-DX 89</p>	<p>cod. 0113 POLTR. MAXI CENTRALE 69</p>	<p>cod. 1230 DIV. 2 P MAXI - 2 RLX 178</p>	<p>cod. 1216/1215 2 P MAXI - 1 RLX SX-DX 178</p>	<p>cod. 1232/1231 2 P MAXI SX-DX - 1 RLX 158</p>	<p>cod. 1228/1227 2 P MAXI SX-DX - 2 RLX 158</p>	
<p>cod. 0200 DIVANO 2 POSTI 156</p>	<p>cod. 0202/0201 2 POSTI SX-DX 136</p>	<p>cod. 0203 2 POSTI CENTRALE 116</p>		<p>cod. 1220 DIV. 2 P - 2 RLX 156</p>	<p>cod. 1206/1205 DIVANO 2 P - 1 RLX SX-DX 156</p>	<p>cod. 1222/1221 2 P SX-DX - 1 RLX 136</p>	<p>cod. 1225/1224 2 P SX-DX - 2 RLX 136</p>	
<p>cod. 0100 POLTRONA 98</p>	<p>cod. 0102/0101 POLTR. LAT. SX-DX 78</p>	<p>cod. 0103 POLTR. CENTRALE 58</p>	<p>cod. 0712/0711 POLTR. PENIS. SX-DX 116</p>	<p>cod. 1120 POLTR. RLX 98</p>	<p>cod. 1122/1121 POLTR. SX-DX - RLX 78</p>	<p>cod. 1125/1124 POL. MAXI SX-DX RLX 89</p>	<p>cod. 1143/1142 POL. 2C SX-DX RLX 99</p>	<p>cod. 1137/1136 POLTR. XL LAT. SX-DX - RLX 140</p>
<p>cod. 0722/0721 2 P PENISOLA SX-DX 174</p>	<p>cod. 0773/0772 ANG. POL. PENISOLA SX-DX 221</p>	<p>cod. 0608 ANG. QUADRO CON MECC. 107</p>		<p>cod. 1118 POLTR. CENTRALE - RLX 58</p>	<p>cod. 1128 POLTR. MAXI CENTR. - RLX 69</p>	<p>cod. 1162 POLTR. CENTR. 2C - RLX 79</p>	<p>cod. 1138 POLTR. XL CENTRALE - RLX 120</p>	<p>cod. 0771/0770 TERM. TRAPEZIO SX-DX 155</p>
<p>cod. 0883/0882 ANG. SAGOMATO POL. PENISOLA SX-DX 228</p>	<p>cod. 0612 ANG. QUADRO SAGOMATO CON MECC. 114</p>							
<p>cod. 0192/0191 POLTR. XL LAT. SX-DX 140</p>	<p>cod. 0193 POLTR. XL CENTRALE 120</p>	<p>cod. 0701/0700 DORM. LAT. SX-DX 165</p>	<p>cod. 0705/0704 DORM. MAXI SX-DX 165</p>	<p>cod. 0697/0696 DORM. 2 C SX-DX 99</p>	<p>cod. 0891/0890 DORM. XL SX-DX 120</p>			
<p>cod. 0176 POLTR. XL 160</p>	<p>cod. 1147 POLTR. XL RLX 160</p>	<p>cod. 0802 POUF RETTANGOLARE 80</p>	<p>h63 h45 107</p>					

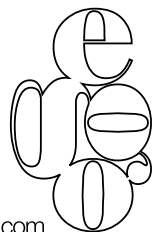
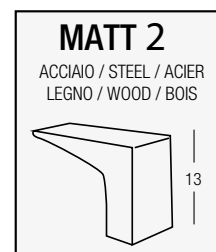
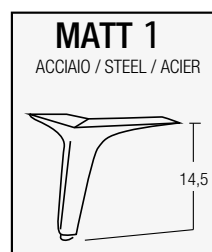

STRUTTURA Realizzata in legno abbinato a particelle di legno grezzo biodegradabile e pannelli di fibra di legno duro.

IMBOTTITURE Cuscino di seduta, braccioli e schienale sono realizzati in poliuretano espanso ecologico a densità differenziate.

Cuscino di seduta a densità differenziata: parte superiore 30 (sc) kg/mc, parte inferiore 30 (nc) kg/mc, ricoperto con una termofalda di dacron autoestinguente da 350 gr/mq.

Braccioli: Realizzati con una lastrina in poliuretano espanso, densità 30 (s) kg/mc ricoperti con dacron resinato da 200 gr/mq.

Cuscino schienale: Realizzato in poliuretano espanso, densità 18 (s) Kg/mc.

ricoperto con termofalda di dacron autoestinguente da 350 gr/mq

Imbottiture di completamento: densità 21 kg/mc.

RIVESTIMENTO Pelle o microfibra non sfoderabile. Per le caratteristiche del rivestimento e della manutenzione vedere relative schede tecniche.

PIEDI Il modello può essere corredato da piedi in legno massello di faggio, disponibili nei colori noce, noce brunito, wengué o verniciati; La poltroncina può essere corredata di una base girevole, in metallo verniciato nero. Altezza piedi o base: cm 5.

NOTE Nella versione relax il modello è realizzato con meccanismo combinato con movimento schienale poggiatesta. Disponibile sia manuale che elettrico con comando posizionato sul bracciolo laterale. Il meccanismo elettrico non è disponibile sulla versione con base girevole.

STRUCTURE En bois, multiplies et particules habillés d'une couche de dacron.

REMBOURRAGE Coussins d'assise, accoudoirs, et dossiers en polyuréthane expansé à double densité. Toutes parties susdites sont recouvertes avec une couche de dacron.

Coussins d'assise : Partie supérieure 30 (sc) kg/m3, partie inférieure 30 (nc) kg/m3 portante. Dacron 350 gr/m2.

Accoudoirs: Polyuréthane expansé 30 (s) kg/mc recouvert avec une couche de dacron 200 gr/m2.

Dossiers: Polyuréthane expansé 18 (s) kg/mc recouvert avec une couche de dacron 350 gr/m2.

Rembourrage de complément : densité 21 kg/m3.

REVETEMENT Cuir ou microfibre non déhoussable. Pour les caractéristique du revêtement aussi bien que pour l'entretien veuillez consulter les fiches techniques appropriés.

PIEDS Le modèle peut être réalisé avec pieds bois coloris noyer, noyer foncé ou wengué; petit fauteuil peut être réalisé avec base en métal pivotante. Pieds ou base H 5cm.

NOTE En version relax le modèle est réalisé avec mécanique combinée repose pieds/dossiers. Disponible en version manuelle ou électrique avec commande située sur le coté de l'accoudoir. La mécanique électrique n'est pas disponible avec base pivotante.

FRAME Hardwood combined with plywood and particle board.

PADDING Seat cushion, armrests and backrests are made in polyurethane foam with varying density. All of the above parts are covers with a Dacron layer.

Seat cushions: Upper part 30 (sc) kg/m3, bottom part 30 (nc) kg/m3. Dacron layer 350 gr/m2.

Armrests: Polyurethane foam 30 kg/m3. Dacron layer 350 gr/m2.

Backrests: Polyurethane foam 18 (s) kg/m3. Dacron layer 350 gr/m2.

Frame padding: 21 kg/m3

COVERING Leather or microfiber. Not removable. Please check covering details for care instructions.

FEET The model can have wooden feet in walnut, dark walnut or wengue.

Little armchair can be equipped with swivel metal base. Feet or base height cm 5.

NOTE In the relax version it is made with combined mechanism: footrest-backrest.

Available both manual or electric with controls placed on the armrest side. With the electric mechanism the model is not available with swivel base.

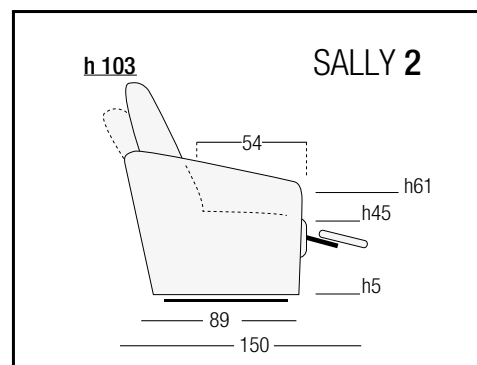
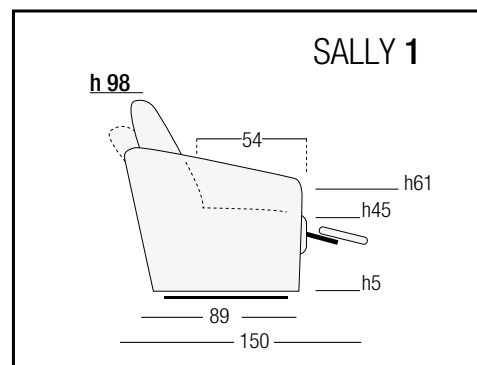
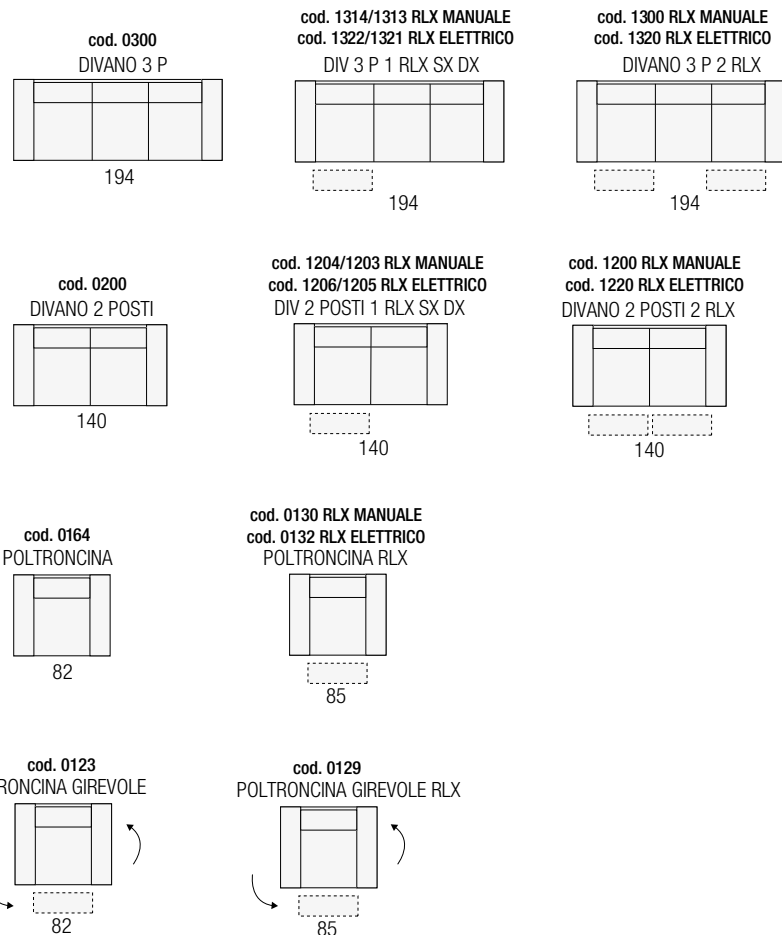

cod. 0164 POLTRONCINA FISSA

cod. 0123 POLTRONCINA GIREVOLE

cod. 0129 POLTRONCINA GIREVOLE / RELAX MANUALE

cod. 0130 POLTRONCINA RELAX MANUALE

cod. 0132 POLTRONCINA RELAX ELETTRICO

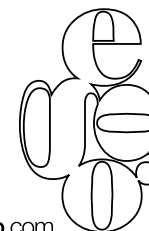

STRUTTURA Realizzata in legno abbinato a particelle di legno grezzo biodegradabile e pannelli di fibra di legno duro.

IMBOTTITURE Cuscini di seduta, braccioli e schienali sono realizzati in poliuretano espanso ecologico a densità differenziate.

Cuscini di seduta: Per le sedute relax: a densità differenziata: strato superiore 30 kg/mc (SS), strato inferiore 30 kg/mc (SC), il tutto ricoperto con una termofalda di dacron autoestinguente da 350 gr/mq. Per le sedute standard: unica densità, 30 kg/mc (SC).

Braccioli: Parte anteriore e superiore, densità 30 kg/mc (NC). Le fiancate dei braccioli sono ricoperte da poliuretano espanso di completamento. I braccioli sono rivestiti con una falda di dacron resinato da 200 gr/mq. Cuscini schienali: densità 23 kg/mc (S) ricoperti con una termofalda di dacron autoestinguente da 350 gr/mq. Imbottiture di completamento: densità 21 kg/mc.

RIVESTIMENTO Pelle o microfibra non sfoderabile. Per le caratteristiche del rivestimento e della manutenzione vedere relative schede tecniche.

PIEDI In ABS cromato, H cm 4.

NOTE Nella versione relax il modello è realizzato con meccanismo combinato con movimento schienale poggiatesta. Disponibile sia manuale che elettrico con comando posizionato sul bracciolo laterale. L'elemento relax è sempre staccato da quello fisso e viene agganciato con apposito sistema a baionetta.

FRAME Hardwood combined with plywood and particle board covered by a layer of polyurethane foam.

PADDING Seat cushion, armrests and backrests are made in polyurethane foam with varying density.

Seat cushions: Relax seats - Upper part 30 (ss) kg/m3, bottom part 30 (sc) kg/m3. Dacron layer 350 gr/m2. Standard seats - density 30 (sc) kg/m3.

Armrests: Front and upper part in polyurethane foam 30 kg/m3 (nc). Armrests are covered with a Dacron layer 200 gr/mq.

Backrests: Polyurethane foam 23 (s) kg/m3. Dacron layer 350 gr/m2.

Frame padding: 21 kg/m3

COVERING Leather or microfiber. Not removable. Please check covering details for care instructions.

FEET In ABS metal effect, H 4.

NOTE The relax version is made with combined mechanism: footrest-backrest available both manual or electric, with controls placed on the armrest side. The part with relax is always delivered separately and connected to the fixed part by made for purpose bayonet fittings.

STRUCTURE En bois, multiples et particules habillés d'une couche de polyuréthane expansé.

REMBOURRAGE Coussins d'assise, accoudoirs, et dossiers en polyuréthane expansé à double densité. Coussins d'assise: Pour les version avec relax, partie supérieure 30 (ss) kg/m3, partie inférieure 30 (sc) kg/m3 portante. L'ensemble couvert d'une couche en dacron 350 gr/m2. Pour les versions fixes: Densité 30 (sc) kg/m3.

Accoudoirs: Partie antérieure et supérieure en polyuréthane expansé 30 (nc) kg/mc recouvert avec une couche de dacron 200 gr/m2.

Dossiers: Polyuréthane expansé 23 (s) kg/mc recouvert avec une couche de dacron 350 gr/m2.

Rembourrage de complément: densité 21 kg/m3.

REVETEMENT Cuir ou microfibre non déhoussable. Pour les caractéristique du revêtement aussi bien que pour l'entretien veuillez consulter les fiches techniques appropriés.

PIEDS En ABS effet métal brillant, H 4 cm.

NOTE En version relax le modèle est réalisé avec mécanique combinée repose pieds/dossiers. Disponible en version manuelle ou électrique avec commande située sur le coté de l'accoudoir. L'élément avec relax est toujours séparé des éléments fixes et relié avec un système à baïonnette.

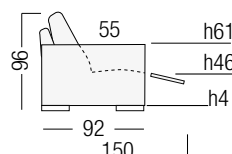
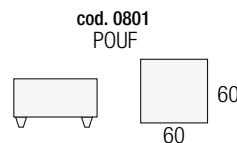
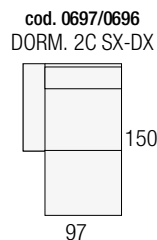
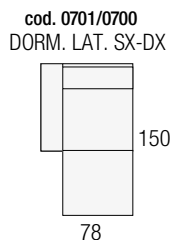
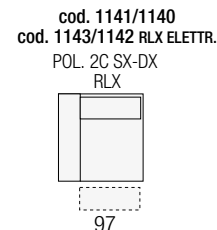
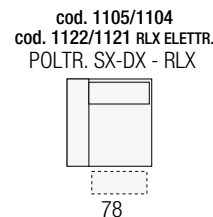
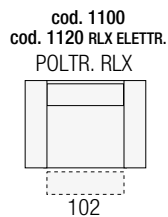
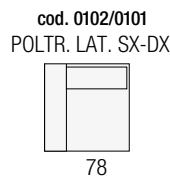
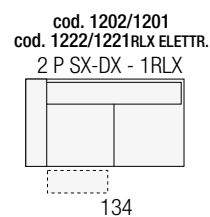
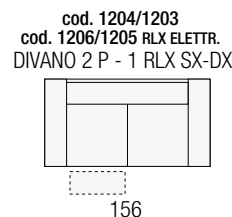
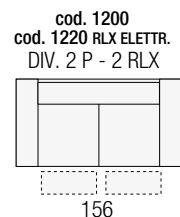
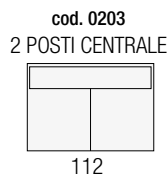
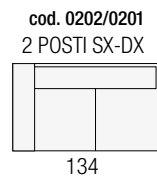
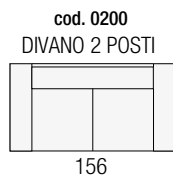
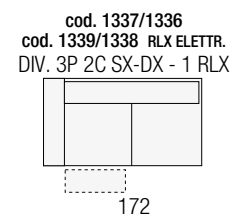
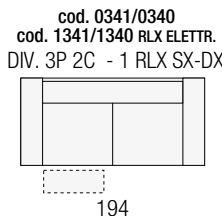
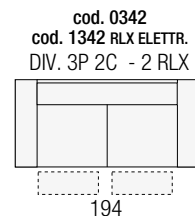
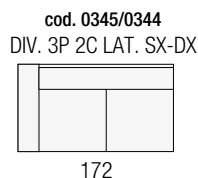
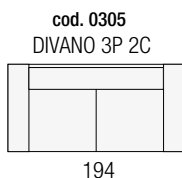
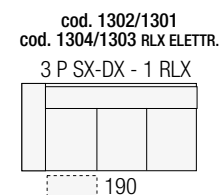
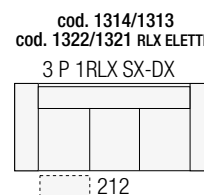
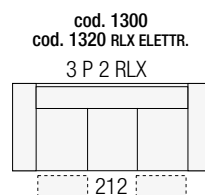
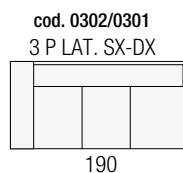

STRUTTURA Realizzata in legno abbinato a particelle di legno grezzo biodegradabile e pannelli di fibra di legno duro.

IMBOTTITURE Cuscini di seduta, braccioli e schienali reclinabili sono realizzati in poliuretano espanso, ricoperte da una termofalda di dacron autoestinguente. Cuscini di seduta: strato superiore di densità 30 kg/mc soffice, strato inferiore di densità 30 kg/mc portante. Termofalda da 350 gr/mq. Braccioli: densità 30 kg/mc. Termofalda da 350 gr/mq. Schienali reclinabili: densità 23 kg/mc. Termofalda da 350 gr/mq. Imbottiture di completamento: densità 21 kg/mc.

RIVESTIMENTO Pelle o microfibra non sfoderabile. Per le caratteristiche del rivestimento e della manutenzione vedere relative schede tecniche.

PIEDI In acciaio inox lucido o con finitura in vernici a polvere epossidica, nei colori bianco perla, grigio ombra o marrone scuro. H: cm 13.

NOTE Nella versione relax il modello è dotato esclusivamente di un doppio meccanismo elettrico con comando posizionato nello spazio interno tra seduta e bracciolo, mentre le sedute centrali sono dotate di un pratico telecomando. I comandi possono agire indipendentemente tra di loro variando solo l'inclinazione della testiera oppure permettendo di distendere solo le gambe offrendo infinite possibilità di comfort. Gli elementi relax sono sempre staccati da quelli fissi e vengono agganciati con apposito sistema a baionetta. Nelle versioni fisse senza meccanismo relax in ogni caso è presente il cricchetto manuale nelle testiere.

FRAME Hardwood combined with plywood and particle board covered by a layer of polyurethane foam.

PADDING Seat cushion, armrests and backrests are made in polyurethane foam with varying density covered with a layer of self extinguishing dacron

Seat cushions: Upper part density 30 kg/m3 soft, bottom part density 30 kg/m3 strong. Dacron layer 350 gr/m2.

Armrests: Polyurethane foam 30 kg/m3 . Armrests are covered with a Dacron layer 350 gr/mq.

Backrests: Polyurethane foam 23 kg/m3. Dacron layer 350 gr/m2. Frame padding: 21 kg/m3

COVERING Leather or microfiber. Not removable. Please check covering details for care instructions.

FEET In brushed steel or in epoxy powder finish, colour pearl white, shadow grey or dark brown. H 13 cm.

NOTE The relax version is exclusively available with double electric mechanism having the controls placed on the seat cushion side, between the seat and the armrest. The armless seats are equipped with a practical remote control. The mechanisms are independent, allowing you to adjust to the desired comfort position either the headrest or the footrest. The version without mechanism always carries the mechanical headrest. The part with relax is always delivered separately and connected to the fixed part by made for purpose bayonet fittings.

STRUCTURE En bois, multiples et particules habillés d'une couche de polyuréthane expansé.

REMBOURRAGE Coussins d'assise, accoudoirs, et dossiers en polyuréthane expansé à double densité recouvert par une couche de dacron autoextinguible. Coussins d'assise : Partie supérieure densité 30 kg/m3 souple et partie inférieure densité 30 kg/m3 portant. Dacron 350 gr/m2.

Accoudoirs: Polyuréthane expansé 30 kg/m3 . Couche de dacron 350 gr/m2. Dossiers: Polyuréthane expansé 23 kg/mc recouvert avec une couche de dacron 350 gr/m2.

Rembourrage de complément : densité 21 kg/m3.

REVETEMENT Cuir ou microfibra non déhoussable. Pour les caractéristique du revêtement aussi bien que pour l'entretien veuillez consulter les fiches techniques appropriés.

PIEDS En acier effet brossé ou avec finition peinture à poudre epoxy coloris blanc perle, gris ombre ou marron foncé. H 13 cm.

NOTE En version relax le modèle est disponible exclusivement avec dubler mécanique électrique avec commande située sur le coté interne entre coussin d'assise et accoudoir, alors que les assises sans bras sont équipées d'une pratique télécommande. Les mécaniques peuvent agir de façon indépendante, permettant de bouger uniquement la tête ou l'assise pour obtenir votre confort idéal. Les versions sans relax ont toujours la tête mécanique. L'élément avec relax est toujours séparé des éléments fixes et relié avec un système à baionnette.

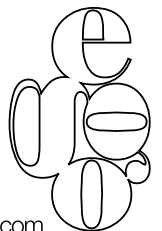
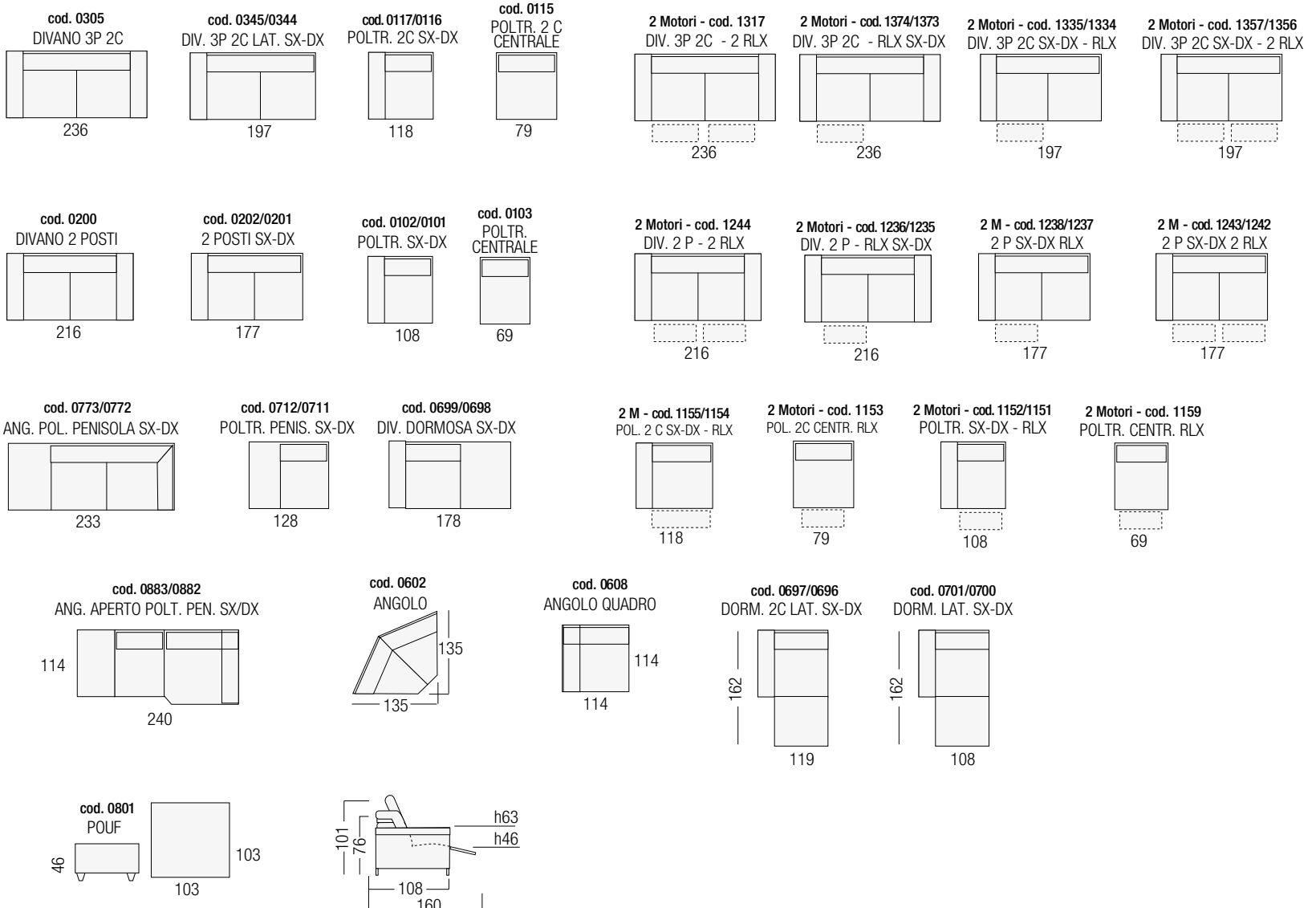

STRUTTURA Realizzata in legno abbinato a particelle di legno grezzo biodegradabile e pannelli di fibra di legno duro.

IMBOTTITURE Cuscini di seduta, braccioli e schienali sono realizzati in poliuretano espanso a densità differenziate. Tutte le parti sopraelencate sono ricoperte da una termofalda di dacron autoestinguente.

Cuscini di seduta: densità 30 SC (30 kg/mc.) Termofalda da 350 gr/mq.
Braccioli : parte superiore, densità 30 kg/mc. con inserti di densità 40 kg/mc.
Termofalda da 400 gr/mq.
Spalliere : densità 25 kg/mc. Termofalda da 450 gr/mq.

Imbottiture di completamento: densità 21 kg/mc.

RIVESTIMENTO Pelle o microfibra non sfoderabile. Per le caratteristiche del rivestimento e della manutenzione vedere relative schede tecniche.

PIEDI In acciaio effetto smerigliato o con finitura in vernice a polvere epossidica, nei colori bianco perla, grigio ombra o marrone scuro. H: cm. 4.

NOTE Nella variante relax il modello è realizzato con meccanismo combinato con movimento schienale poggiatesta. Nello schienale è inserita una coppia di barre in acciaio armonico che si flettono nel movimento di apertura del meccanismo e permettono di configurare la seduta nel suo comfort ottimale. Disponibile esclusivamente in versione con motore elettrico dotato di comando a sfioramento posto sul lato interno del bracciolo. L'elemento relax è sempre staccato da quello fisso e viene agganciato con apposito sistema a baionetta.

FRAME Hardwood combined with plywood and particle board covered by a layer of polyurethane foam.

PADDING Seat cushion, armrests and backrests are made in polyurethane foam with varying density covered with a layer of self extinguishing dacron
Seat cushions: Density 30 SC kg/m3. Dacron layer 350 gr/m2.

Armrests: Upper part in polyurethane foam 30 kg/m3 with parts in 40 kg/m3 .
Armrests are covered with a Dacron layer 400 gr/mq.
Backrests: Polyurethane foam 25 kg/m3. Dacron layer 450 gr/m2.

Frame padding: 21 kg/m3

COVERING Leather or microfiber. Not removable. Please check covering details for care instructions.

FEET In brushed steel or in epoxy powder finish, colour pearl white, shadow grey or dark brown. H 4 cm.

NOTE The relax version is made with combined mechanism: footrest-backrest. Backrests are equipped with a pair of harmonic steel bars that flex during the opening movement. These bars allow you to block the seat into your desired comfort position. Available only with electric mechanism, with touch sensor controls placed on the armrest side. The part with relax is always delivered separately and connected to the fixed part by made for purpose bayonet fittings.

STRUCTURE En bois, multiplies et particules habillés d'une couche de polyuréthane expansé.

REMBOURRAGE Coussins d'assise, accoudoirs, et dossiers en polyuréthane expansé à double densité recouvert par une couche de dacron autoextinguible.
Coussins d'assise : Densité 30 SC kg/m3 et dacron 350 gr/m2.

Accoudoirs: Partie supérieure en polyuréthane expansé 30 kg/mc avec parties en densité 40 kg/mc. Couche de dacron 400 gr/m2.

Dossiers: Polyuréthane expansé 25 kg/mc recouvert avec une couche de dacron 450 gr/m2.

Rembourrage de complément : densité 21 kg/m3.

REVETEMENT Cuir ou microfibre non déhoussable. Pour les caractéristique du revêtement aussi bien que pour l'entretien veuillez consulter les fiches techniques appropriés.

PIEDS En acier effet brossé ou avec finition peinte à poudre epoxy coloris blanc perle, gris ombre ou marron foncé. H 4 cm.

NOTE En version relax le modèle est réalisé avec mécanique combinée repose pieds/dossiers. Dans les dossiers une paire de barres d'acier harmonique se plient dans le mouvement d'ouverture du mécanisme vous permettant de bouger l'assise à votre plaisance. Disponible exclusivement en version électrique avec commande « touch sensor » située sur le coté de l'accoudoir. L'élément avec relax est toujours séparé des éléments fixes et relié avec un système à baionnette.

VERSIONE STANDARD

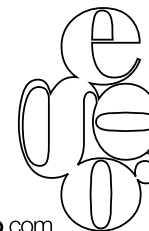
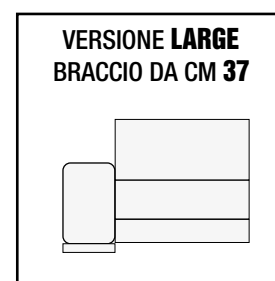
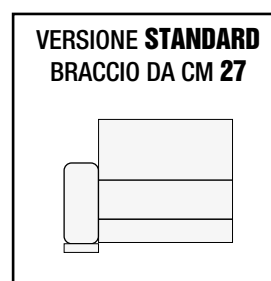
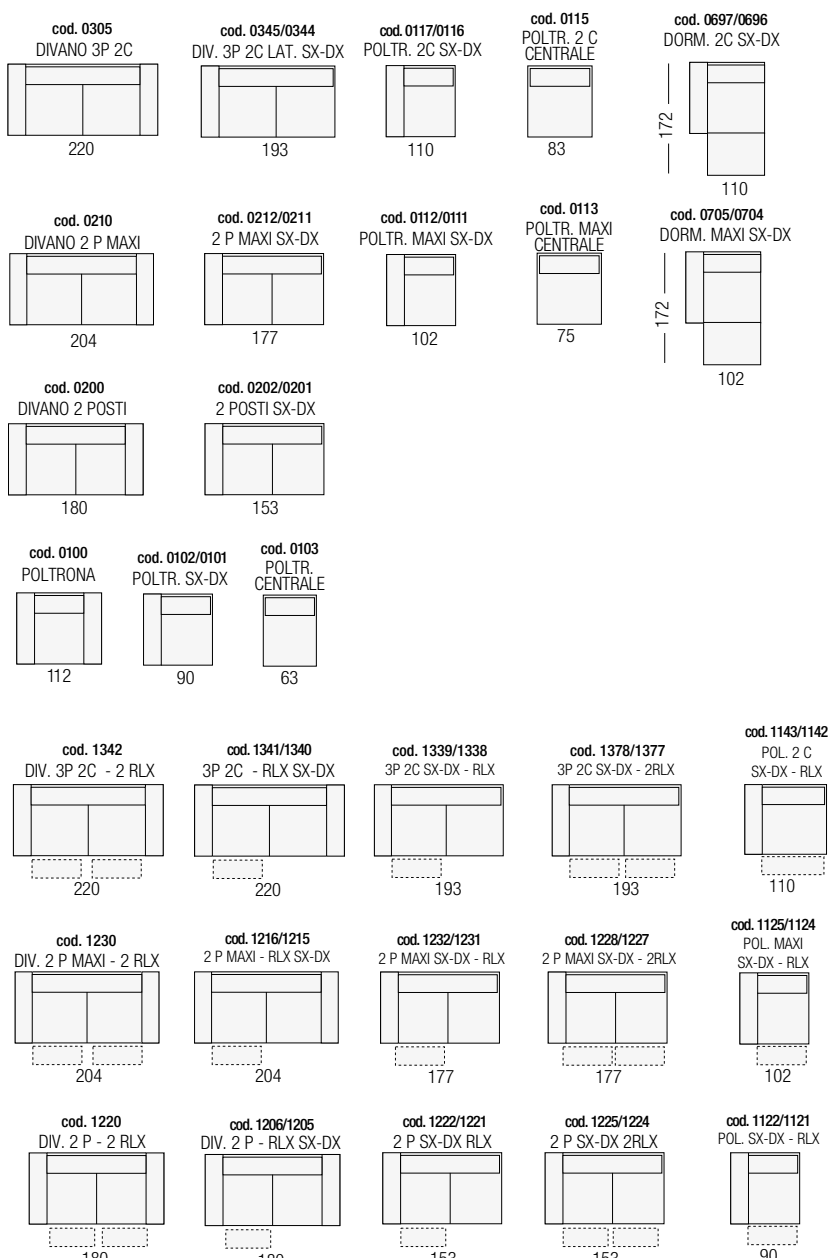

STRUTTURA Realizzata in legno abbinato a particelle di legno grezzo biodegradabile e pannelli di fibra di legno duro.

IMBOTTITURE Cuscini di seduta, braccioli, poggiatesta e spalliere poggiatesta reclinabili sono realizzate in poliuretano espanso. Tutte le parti sopraelencate sono ricoperte da una termofalda di dacron autoestinguente.

Cuscini di seduta a densità differenziata: parte superiore di densità 35 kg/mc soffice, parte inferiore di densità 35 kg/mc portante, ricoperti da una termofalda da 350 gr/mq.

Braccioli: densità 30 kg/mc con inserti di densità 40 Kg/mc. Termofalda da 400 gr/mq.

Poggiatesta: densità 25 kg/mc. Termofalda da 450 gr/mq.

Spalliere poggiatesta: densità 25 kg/mc. Termofalda da 450 gr/mq.

Imbottiture di completamento: densità 21 kg/mc.

RIVESTIMENTO Pelle non sfoderabile, microfibra o tessuto sfoderabile. Per le caratteristiche del rivestimento e della manutenzione vedere relative schede tecniche.

PIEDI In acciaio inox lucidato oppure in legno massello di faggio evaporato, nei colori wengé, noce brunito, noce o con finitura in vernici a polvere epossidica, nei colori bianco perla, grigio ombra o marrone scuro. H: cm. 13.

NOTE Le versioni letto sono dotate di reti a due pieghe elettrosaldate, realizzate in acciaio ad alta resistenza, verniciate a forno con polveri epossidiche.

Reti : divano 3 posti: 180 x 201; divano 2 posti maxi:

160 x 201; 2 posti: 140 x 201; poltrona: 90 x 201.

Materassi : in poliuretano espanso divano 3 posti: 160 x 193 x 13; divano 2 posti maxi: 140 x 193 x 13; divano 2 posti: 120 x 193 x 13; poltrona: 70 x 193 x 13.

FRAME Hardwood combined with plywood and particle board.

PADDING Seat cushion, armrests, lumbar supports and backrests-headrests are made in polyurethane foam. Every part mentioned is covered with a layer of self extinguishing dacron.

Seat cushions with varying density: Upper part 35 kg/m3 soft, bottom part 35 kg/m3 supporting. Dacron layer 350 gr/m2.

Armrests: Polyurethane foam 30 kg/m3 with part in density 40 kg/m3. Dacron layer 400 gr/m2.

Lumbar supports: Polyurethane foam 25 kg/m3. Dacron layer 450 gr/m2.

Backrests-headrests: Polyurethane foam 25 kg/m3. Dacron layer 450 gr/m2.

Frame padding: Polyurethane foam 21 kg/m3.

COVER Leather not removable. Fabric or microfiber fully removable. Please check covering details for care instructions.

FEET In polished steel or in beech wood coloured wengé, walnut or dark walnut or epoxy powder finish, colour pearl white, shadow grey or dark brown. H 13 cm.

NOTE Bed versions are equipped with two folds electro-welded bed mechanisms made of steel painted with epoxy powder finishes baked.

Mechanisms: 3 seater 180 x 201; 2 seater maxi 160 x 201; 2 seater 140 x 201; Armchair 90 x 201.

Mattress : in polyurethane foam 3 seater 160 x 193 x 13; 2 seater maxi 140 x 193 x 13; 2 seater 120 x 193 x 13; Armchair 70 x 193 x 13.

STRUCTURE En bois, multiples et particules habillés d'une couche de dacron.

REMBOURRAGE Coussins d'assise, accoudoirs, cale reins et dossiers appui-tête en polyuréthane expansé.

Toutes les parties indiquées sont couverte par une couche de dacron autoextinguible.

Coussins d'assise à densité différenciée: Partie supérieure 35 kg/m3 souple, partie inférieure 35 kg/m3 portante. Couche en dacron 350 gr/m2.

Accoudoirs: Polyuréthane expansé 30 kg/m3 avec parties en densité 40 kg/m3 recouvert avec une couche de dacron 400 gr/m2.

Cale reins: Polyuréthane expansé 25 kg/m3 recouvert avec une couche de dacron 450 gr/m2.

Dossiers appui-tête: Polyuréthane expansé 25 kg/m3 recouvert avec une couche de dacron 450 gr/m2.

Rembourrage de complément : densité 21 kg/m3.

REVETEMENT Cuir non déhoussable. Microfibre ou tissu déhoussable. Pour les caractéristique du revêtement aussi bien que pour l'entretien veuillez consulter les fiches techniques appropriées.

PIEDS En acier poli ou en hêtre massif teinté wengés, noyer ou noyer foncé ou bien avec finition peinture à poudre epoxy coloris blanc perle, gris ombre ou marron foncé. H 13 cm.

NOTE Les versions lit sont équipées avec sommier deux plis électro-soudé, réalisé en acier à haute résistance, peint avec des poudres epoxy au four.

Sommiers : 3 places 180 x 201; 2places maxi 160 x 201; 2 places 140 x 201; Fauteuil 90 x 201.

Matelas : en polyuréthane 3 places 160 x 193 x 13; 2places maxi 140 x 193 x 13; 2 places 120 x 193 x 13; Fauteuil 70 x 193 x 13.

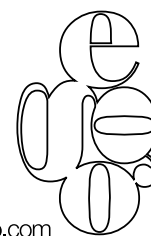
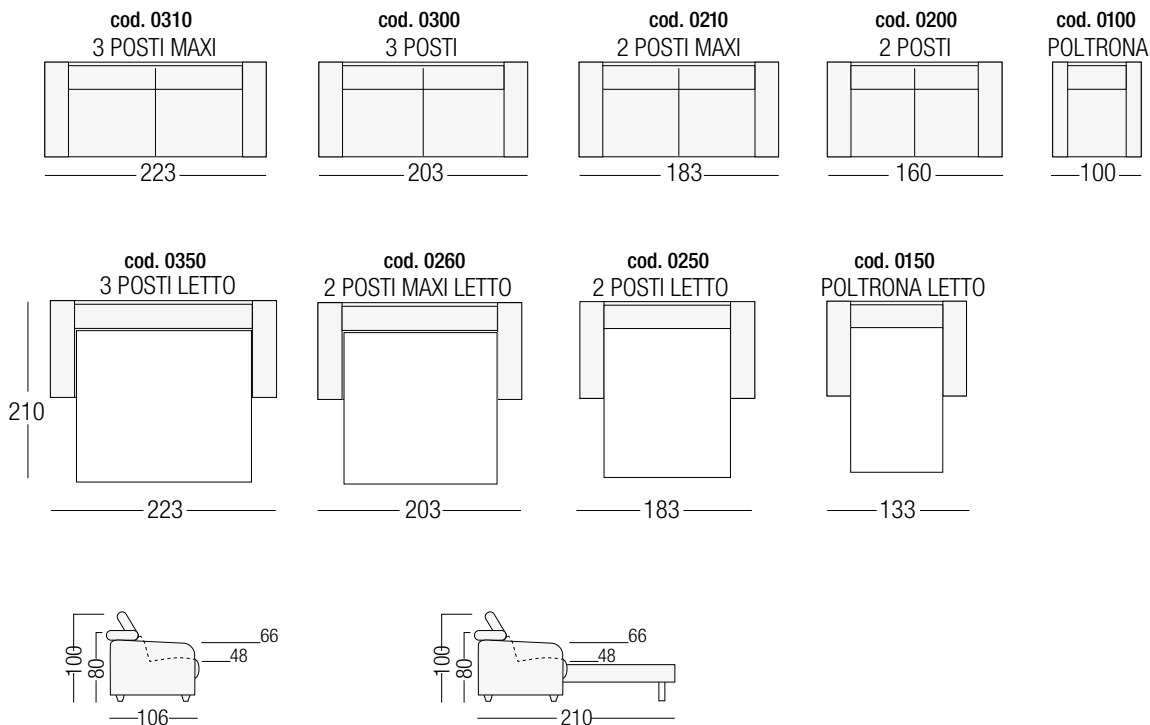

STRUTTURA Realizzata in legno abbinato a particelle di legno grezzo biodegradabile e pannelli di fibra di legno duro.

IMBOTTITURE Cuscino schienale realizzato in poliuretano espanso di densità 30 kg/mc. con zona poggiatesta di densità 23 kg/mc. Cuscino di seduta realizzato in poliuretano espanso di densità 30 kg/mc.

Schienale e seduta sono ricoperti entrambi da una termofalda di dacron autoestinguente da 350 gr/ mq. Le imbottiture di completamento sono realizzate in poliuretano espanso di densità 21 kg/mc.

RIVESTIMENTO Pelle o microfibra non sfoderabile. Per le caratteristiche del rivestimento e della manutenzione vedere relative schede tecniche.

PIEDI la poltroncina poggia su una base girevole realizzata in acciaio lucido e misura cm 19 in altezza e cm 58 di diametro. E' possibile richiedere la base realizzata con finitura in vernici a polvere epossidica, nei colori bianco perla, grigio ombra o marrone scuro.

FRAME ardwood combined with plywood and particle board.

PADDING Back cushion in polyurethane foam 30 kg/m3, with lumbar support area in foam density 23 kg/mc.

Seat cushions in polyurethane foam 30 kg/m3.

Seat and back cushion covered with dacron layer 350 gr/m2.

Frame padding: 21 kg/m3

COVERING Leather or microfiber. Not removable. Please check covering details for care instructions.

FEET Swivel base in shiny stainless steel H19 cm and 58 cm diameter.

Also available in epoxy powder finish, colour pearl white, shadow grey or dark brown.

STRUCTURE En bois, multiples et particules habillés d'une couche de dacron.

REMBOURRAGE Coussin de dossier en polyuréthane expansé densité 30 kg/m3 avec cales-reins densité 23 kg/m3. Dacron 350 gr/m2.

Coussins d'assise en polyuréthane expansé densité 30 kg/m3. Dacron 350 gr/m2.

Rembourrage de complément : densité 21 kg/m3.

RETEMENT Cuir ou microfibre non déhoussable. Pour les caractéristique du revêtement aussi bien que pour l'entretien veuillez consulter la fiches techniques appropriés.

PIEDS Base pivotante en acier brillant ayant 19 cm de hauteur et 58 cm de diamètre. Il est aussi disponible en acier peint aux vernis époxy au four coloris blanc perle, gris ombre ou marron foncé.

cod. 0123
POLTRONCINA GIREVOLE

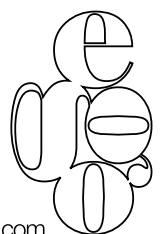
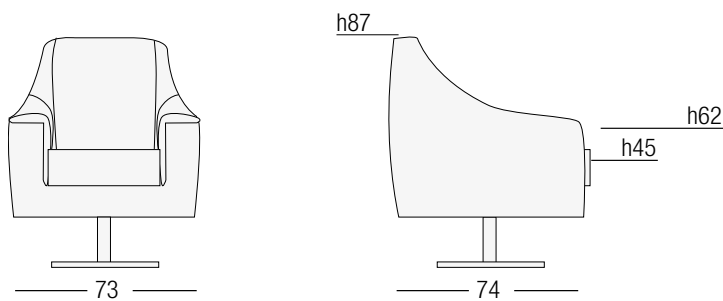

STRUTTURA Realizzata in legno abbinato a particelle di legno grezzo biodegradabile e pannelli di fibra di legno duro.

IMBOTTITURE Cuscino di seduta realizzato in poliuretano espanso di densità 30 kg/mc. Poggiatesta realizzato in poliuretano espanso di densità 23 kg/mc. con poggiatesta di densità 30 kg/mc.

Seduta, poggiatesta e poggiatesta sono ricoperti da una termofalda di dacron autoestinguente da 350 gr/ mq. Braccioli di densità 30 kg/mc. ricoperti di dacron resinato da 200 gr/mq. Le imbottiture di completamento sono realizzate in poliuretano espanso di densità 21 kg/mc.

RIVESTIMENTO Pelle o microfibra non sfoderabile. Per le caratteristiche del rivestimento e della manutenzione vedere relative schede tecniche.

PIEDI La poltroncina è dotata di una base circolare realizzata in tubolare d'acciaio verniciato, ruotante a 360°, oppure di piedini in legno massello di faggio evaporato, verniciati nelle tinte bianco perla, grigio ombra, marrone scuro. H base /piedini: cm 5.

NOTE La poltroncina Nanette è dotata di una testiera con cricchetti a snodo, regolabile a seconda del tipo di comfort desiderato.

FRAME Hardwood combined with plywood and particle board.

PADDING Seat cushion in polyurethane foam 30 kg/m3, with lumbar support area in foam density 23 kg/mc and head rest in foam density 23 kg/mc.

Seat cushion, lumbar support and headrest are covered with a layer of self extinguishing Dacron of 350 gr /sq m.

Armrest in polyurethane foam 30 kg/m3 covered with a layer of Dacron of 200 gr /sq m.

Frame padding: 21 kg/m3

COVERING Leather or microfiber. Not removable. Please check covering details for care instructions.

FEET The chair is equipped with a tubular steel circular base, swivelling at 360°, or on wooden feet colour pearl white, shadow grey o dark brown. H base / feet 5 cm.

NOTE Armchair Nanette is equipped with an adjustable headrest.

STRUCTURE En bois, multiples et particules habillés d'une couche de dacron.

REMBOURRAGE Coussin d'assise en polyuréthane expansé densité 30 kg/m3 avec cales-reins densité 23 kg/m3 et tête en densité 30 kg/mc. Assise, cales-reins et tête son couvert par une couche de dacron autoextinguible 350 gr/m2.

Accoudoirs en polyuréthane expansé densité 30 kg/m3 couvert par une couche de dacron autoextinguible 200 gr/m2.

Rembourrage de complément : densité 21 kg/m3.

REVETEMENT Cuir ou microfibre non déhoussable. Pour les caractéristique du revêtement aussi bien que pour l'entretien veuillez consulter la fiches techniques appropriés.

PIEDS Le fauteuil est équipé avec une base circulaire en tubulaire en acier peint, pivotant sur 360°, ou bien sur pieds en bois de hêtre coloris blanc perle, gris ombre ou marron foncé.

NOTE Le fauteuil Nanette est équipé d'un appui-tête réglable à crémaillère.

NANETTE PLUS

NOTE In Nanette plus c'è l'innovazione in grado di offrire all'utente una nuova esperienza di comfort attraverso l'unione di tre "plus":

+ergonomia, garantita da una particolare imbottitura, scavata sia sulla seduta che sullo schienale e la cui forma è frutto di studi ergonomici, che si armonizza al peso e al comfort ricercato dall'utente. Nanette plus è inoltre dotata di una testiera regolabile tramite cricchetti a snodo.

+durata, grazie alla presenza di un pannello traspirante, utilizzato per la struttura della seduta ed inclinato secondo precise angolazioni, che sostituisce le classiche cinghie, soggette a maggiore usura e a perdita di elasticità.

+sostegno, assicurato dall'implementazione di un dispositivo ammortizzante in grado di smorzare le forze in fase di seduta, anche in presenza di "taglie forti", e quelle di ritorno elastico quando ci si alza.

NOTE In Nanette plus there is innovation able to offer to its user a new experience of comfort through the union of three "pluses":

+ ergonomics, which is guaranteed by a special carved padding on the seat and on the back. Its shape is the result of ergonomic studies, allowing the padding to adapt to the weight and comfort sought by the user. Nanette plus is also equipped with an adjustable headrest.

+ duration, thanks to the presence of a breathable panel, used for the structure of the seat and tilted according to precise angles, which replaces the classical belts, subject to greater wear and loss of elasticity.

+ support, ensured by the implementation of a damping device able to dampen the forces during sitting, even in the presence of "XL Sizes", and those of the elastic return when rising.

NOTE En Nanette plus il ya de l'innovation capable d'offrir à l'utilisateur une nouvelle expérience de confort grâce à l'union de trois «plus»:

+ d'ergonomie, qui est garantie par un rembourrage spécial, creusé sur le siège et sur le dos et dont la forme est le résultat d'études ergonomiques. Ce rembourrage s'adapte au poids et au confort recherché par l'utilisateur. Nanette plus est également équipée d'un appui-tête réglable à crémaillère.

+ de durée, grâce à la présence d'un panneau perméable à l'air, utilisé pour la structure du siège et inclinée selon des angles précis, qui remplace les sangles élastiques classiques qui subissent une plus grande usure et perte d'élasticité.

+ de Support, assurée par la mise en œuvre d'un dispositif d'amortissement apte à amortir les forces en position assise, même en présence de "Poids lourds", et celles du retour élastique en se levant.

cod. 0123

POLTRONCINA GIREVOLE

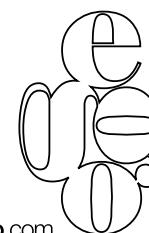
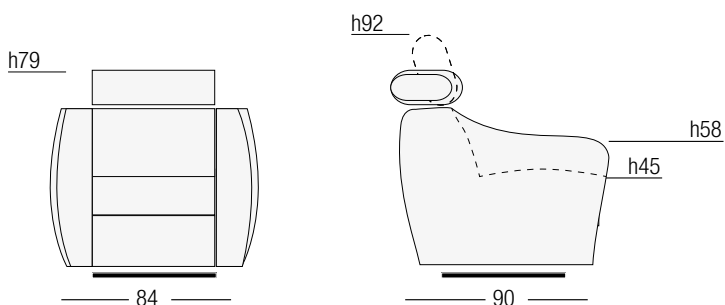

STRUTTURA Realizzata in legno abbinato a particelle di legno grezzo biodegradabile e pannelli di fibra di legno duro.

IMBOTTITURE Cuscini di seduta, braccioli e schienali sono realizzati in poliuretano espanso a densità differenziate. Tutte le parti sopraelencate sono ricoperte da una termofalda di dacron autoestinguente.

Cuscini di seduta: densità 30 SC (30 kg/mc.) Termofalda da 350 gr/mq.

Braccioli : densità 23 kg/mc. Termofalda da 450 gr/mq.

Spalliere : densità 25 kg/mc. Termofalda da 450 gr/mq.

Imbottiture di completamento: densità 21 kg/mc.

RIVESTIMENTO Pelle o microfibra non sfoderabile. Per le caratteristiche del rivestimento e della manutenzione vedere relative schede tecniche.

PIEDI In legno massello di faggio evaporato, tinto con vernici all'acqua ecologiche, nei colori wengè, noce brunito, noce.

NOTE Nella variante relax il modello è realizzato con meccanismo combinato con movimento schienale poggiatesta. Nello schienale è inserita una coppia di barre in acciaio armonico che si flettono nel movimento di apertura del meccanismo e permettono di configurare la seduta nel suo comfort ottimale. Disponibile esclusivamente in versione con motore elettrico dotato di comando a sfioramento posto sul lato interno del bracciolo. L'elemento relax è sempre staccato da quello fisso e viene agganciato con apposito sistema a baionetta.

FRAME Hardwood combined with plywood and particle board covered by a layer of polyurethane foam.

PADDING Seat cushion, armrests and backrests are made in polyurethane foam with varying density covered with a layer of self extinguishing dacron

Seat cushions: Density 30 SC kg/m³. Dacron layer 350 gr/m².

Armrests: Upper in polyurethane foam 23 kg/m³. Armrests are covered with a Dacron layer 450 gr/mq.

Backrests: Polyurethane foam 25 kg/m³. Dacron layer 450 gr/m².

Frame padding: 21 kg/m³

COVERING Leather or microfiber. Not removable. Please check covering details for care instructions.

FEET In beech wood coloured with water based paint in wengué, walnut or dark walnut.

NOTE The relax version is made with combined mechanism: footrest-backrest. Backrests are equipped with a pair of harmonic steel bars that flex during the opening movement. These bars allow you to block the seat into your desired comfort position. Available only with electric mechanism, with touch sensor controls placed on the armrest side. The part with relax is always delivered separately and connected to the fixed part by made for purpose bayonet fittings.

STRUCTURE En bois, multiplies et particules habillées d'une couche de polyuréthane expansé.

REMBOURRAGE Coussins d'assise, accoudoirs, et dossiers en polyuréthane expansé à double densité recouvert par une couche de dacron autoextinguible. Coussins d'assise : Densité 30 SC kg/m³ et dacron 350 gr/m².

Accoudoirs: En polyuréthane expansé 23 kg/mc. Couche de dacron 450 gr/m².

Dossiers: Polyuréthane expansé 25 kg/mc recouvert avec une couche de dacron 450 gr/m².

Rembourrage de complément : densité 21 kg/m³.

REVETEMENT Cuir ou microfibre non déhoussable. Pour les caractéristique du revêtement aussi bien que pour l'entretien veuillez consulter les fiches techniques appropriés.

PIEDS En hêtre massif teinté avec vernis écologiques à base d'eau, dans les coloris wengués, noyer e noyer foncé.

NOTE En version relax le modèle est réalisé avec mécanique combinée repose pieds/dossiers. Dans les dossiers une paire de barres d'acier harmonique se plient dans le mouvement d'ouverture du mécanisme vous permettant de bouger l'assise à votre plaisir. Disponible exclusivement en version électrique avec commande « touch sensor » située sur le coté de l'accoudoir. L'élément avec relax est toujours séparé des éléments fixes et relié avec un système à baïonnette.

VERSIONE BRACCIO DA CM 31

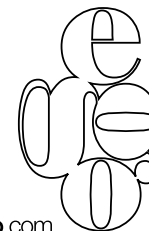
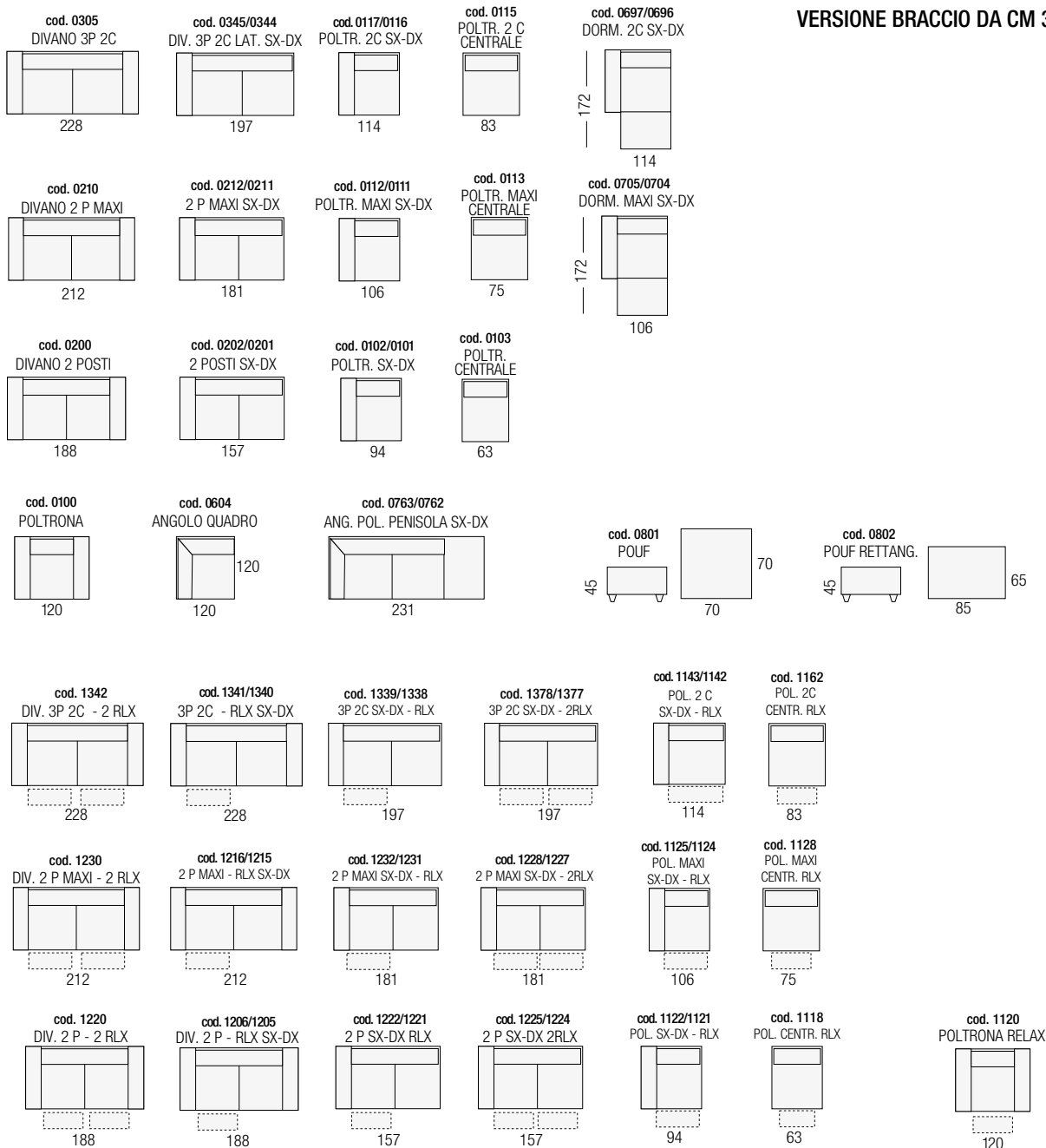

STRUTTURA Realizzata in legno abbinato a particelle di legno grezzo biodegradabile e pannelli di fibra di legno duro.

IMBOTTITURE Cuscini di seduta, braccioli e schienali sono realizzati in poliuretano espanso a densità differenziate.

Cuscini di seduta: densità 30 kg/mc ricoperti con una termofalda di dacron autoestinguente da 350 gr/mq.

Braccioli: densità 23 kg/mc ricoperti con una termofalda di dacron autoestinguente da 350 gr/mq.

Spalliere: realizzati in fibra poliestere siliconata in fiocchi.

Imbottiture di completamento: densità 21 kg/mc.

RIVESTIMENTO Pelle o microfibra non sfoderabile. Per le caratteristiche del rivestimento e della manutenzione vedere relative schede tecniche.

PIEDI In legno massello di faggio evaporato tinto con vernici ecologiche ad acqua, nei colori: noce brunito, wengè, H: 4 cm

NOTE Nella variante relax il modello è realizzato con meccanismo combinato con movimento schienale poggiatesta. Disponibile sia manuale che elettrico con comando posizionato sul bracciolo laterale. L'elemento relax è sempre staccato da quello fisso e viene agganciato con apposito sistema a baionetta.

FRAME Hardwood combined with plywood and particle board covered by a layer of polyurethane foam.

PADDING Seat cushion, armrests and backrests are made in polyurethane foam with varying density.

Seat cushions: Density 30 Kg/m3, covered with a layer of self extinguishing dacron 350 gr/m2

Armrests: Density 23 Kg/m3, covered with a layer of self extinguishing dacron 350 gr/m2

Backrests: Polyester silicon Hollowfibre.

Frame padding: 21 kg/m3

COVERING Leather or microfiber. Not removable. Please check covering details for care instructions.

FEET Made of solid beech wood stained with ecological water based paints available in the following colours: burnished walnut, wenge, H: 4 cm

NOTE The relax version is made with combined mechanism: footrest-backrest. Available with manual or electric mechanism, with controls placed on the armrest side. The part with relax is always delivered separately and connected to the fixed part by made for purpose bayonet fittings.

STRUCTURE En bois, multiplies et particules habillés d'une couche de polyuréthane expansé.

REMBOURRAGE Coussins d'assise, accoudoirs, et dossiers en polyuréthane expansé à double densité.

Coussins d'assise: Densité 30 kg/m3 et couverts d'une couche en dacron 350 gr/m2.

Accoudoirs: Densité 23 kg/m3 et couverts d'une couche en dacron 350 gr/m2.

Dossiers: Flocons de polyester siliconé creux.

Rembourrage de complément: densité 21 kg/m3.

REVETEMENT Cuir ou microfibre non déhoussable. Pour les caractéristique du revêtement aussi bien que pour l'entretien veuillez consulter les fiches techniques appropriés.

PIEDS En hêtre massif teinté avec vernis écologiques à base d'eau, disponible dans les couleurs noyer bruni et wengé. H 4 cm.

NOTE En version relax le modèle est réalisé avec mécanique combinée repose pieds/dossiers. Disponible en version manuelle ou électrique avec commande située sur le côté de l'accoudoir. L'élément avec relax est toujours séparé des éléments fixes et relié avec un système à baïonnette.

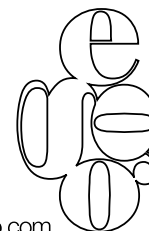
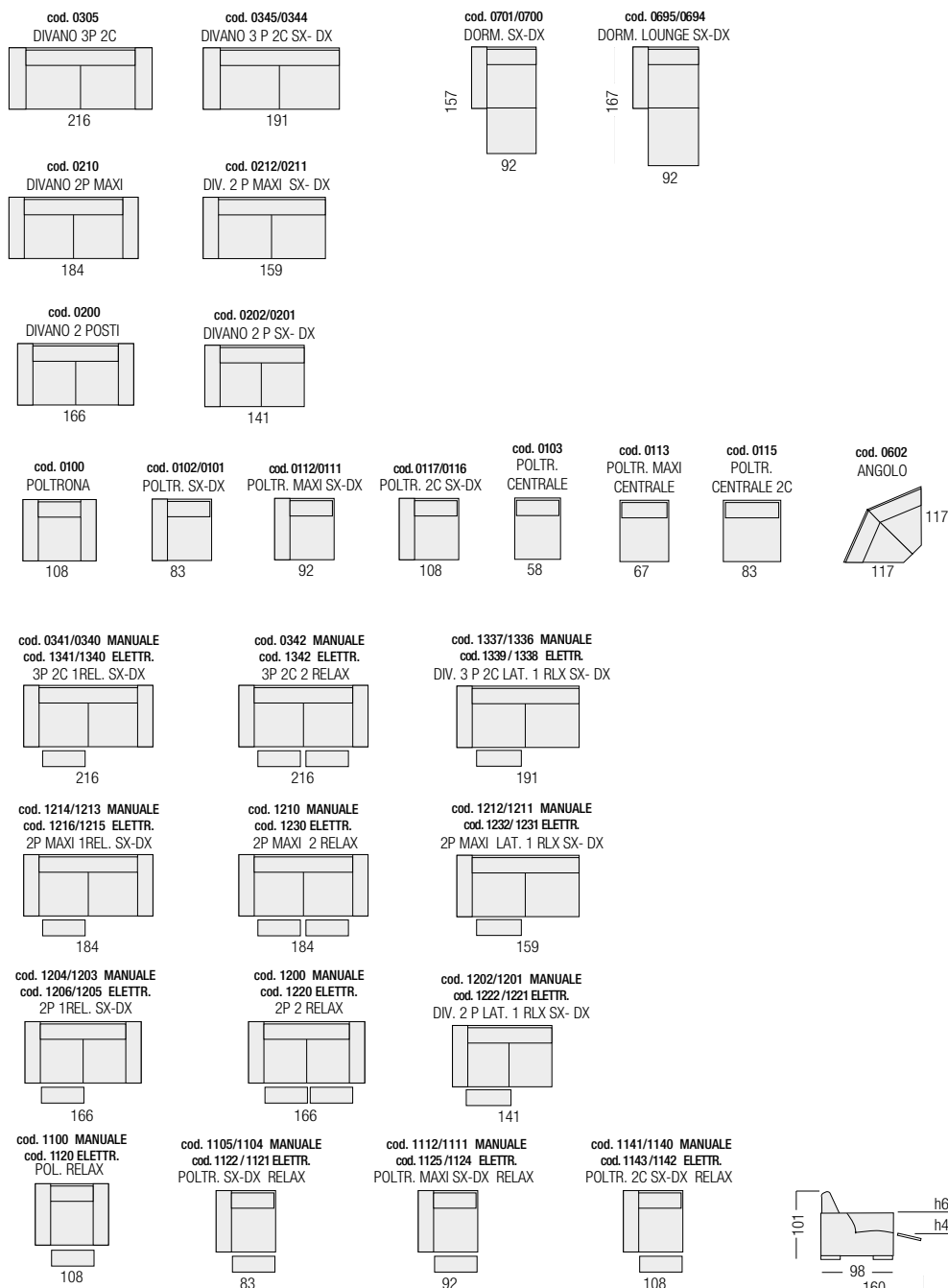

STRUTTURA Realizzata in legno abbinato a particelle di legno grezzo biodegradabile e pannelli di fibra di legno duro.

IMBOTTITURE Cuscini di seduta, braccioli e schienali sono realizzati in poliuretano espanso a densità differenziate.

Cuscini di seduta: densità 30 kg/mc ricoperti con una termofalda di dacron autoestinguente da 350 gr/mq.

Braccioli : densità 23 kg/mc ricoperti con una termofalda di dacron autoestinguente da 350 gr/mq.

Spalliere : realizzati in fibra poliestere siliconata in fiocchi.

Imbottiture di completamento: densità 21 kg/mc.

RIVESTIMENTO Pelle o microfibra non sfoderabile. Per le caratteristiche del rivestimento e della manutenzione vedere relative schede tecniche.

PIEDI In legno massello di faggio evaporato tinto con vernici ecologiche ad acqua, nei colori: noce brunito, wengè, H: cm 4

NOTE Nella variante relax il modello è realizzato con meccanismo combinato con movimento schienale poggiapiedi. Disponibile sia manuale che elettrico con comando posizionato sul bracciolo laterale. L'elemento relax è sempre staccato da quello fisso e viene agganciato con apposito sistema a baionetta.

FRAME Hardwood combined with plywood and particle board covered by a layer of polyurethane foam.

PADDING Seat cushion, armrests and backrests are made in polyurethane foam with varying density.

Seat cushions: Density 30 Kg/m3, covered with a layer of self extinguishing dacron 350 gr/m2

Armrests: Density 23 Kg/m3, covered with a layer of self extinguishing dacron 350 gr/m2

Backrests: Polyester silicon Hollowfibre.

Frame padding: 21 kg/m3

COVERING Leather or microfiber. Not removable. Please check covering details for care instructions.

FEET Made of solid beech wood stained with ecological water based paints available in the following colours: burnished walnut, wenge, H: 4 cm

NOTE The relax version is made with combined mechanism: footrest-backrest. Available with manual or electric mechanism, with controls placed on the armrest side. The part with relax is always delivered separately and connected to the fixed part by made for purpose bayonet fittings.

STRUCTURE En bois, multiplies et particules habillés d'une couche de polyuréthane expansé.

REMBOURRAGE Coussins d'assise, accoudoirs, et dossiers en polyuréthane expansé à double densité.

Coussins d'assise : Densité 30 kg/m3 et couverts d'une couche en dacron 350 gr/m2.

Accoudoirs: Densité 23 kg/m3 et couverts d'une couche en dacron 350 gr/m2.

Dossiers: Flocons de polyester siliconé creux.

Rembourrage de complément : densité 21 kg/m3.

REVETEMENT Cuir ou microfibre non déhoussable. Pour les caractéristique du revêtement aussi bien que pour l'entretien veuillez consulter les fiches techniques appropriés.

PIEDS En hêtre massif teinté avec vernis écologiques à base d'eau, disponible dans les couleurs noyer bruni et wengé. H 4 cm.

NOTE En version relax le modèle est réalisé avec mécanique combinée repose pieds/dossiers. Disponible en version manuelle ou électrique avec commande située sur le côté de l'accoudoir. L'élément avec relax est toujours séparé des éléments fixes et relié avec un système à baionnette.

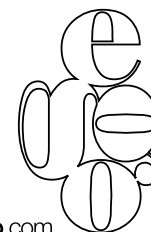
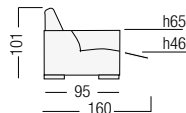
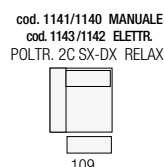
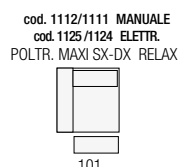
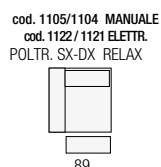
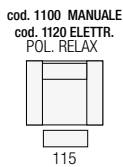
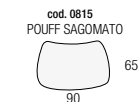
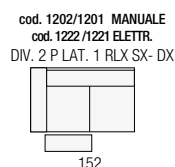
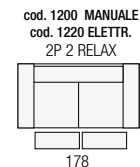
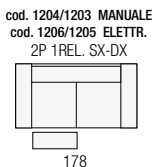
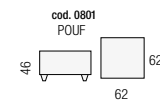
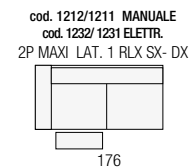
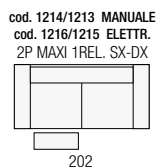
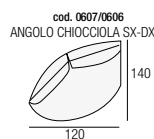
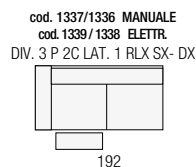
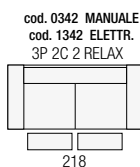
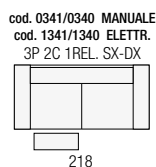
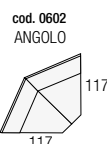
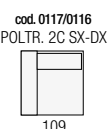
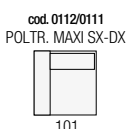
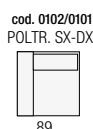
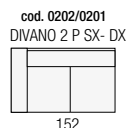
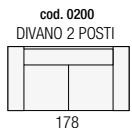
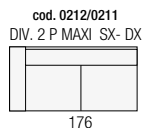
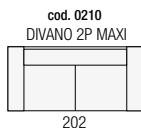
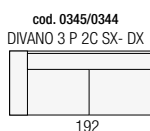
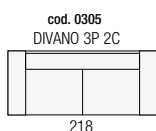

STRUTTURA Realizzata in legno abbinato a particelle di legno grezzo biodegradabile e pannelli di fibra di legno duro.

IMBOTTITURE Cuscini di seduta, braccioli, poggiareni e spalliere poggiatesta reclinabili sono realizzate in poliuretano espanso. Tutte le parti sopraelencate sono ricoperte da una termofalda di dacron autoestinguente.

Cuscini di seduta a densità differenziata: parte superiore di densità 30 kg/mc soffice, parte inferiore di densità 30 kg/mc portante, ricoperti da una termofalda da 350 gr/mq.

Braccioli: densità 40 kg/mc. con complementi da 21 kg/mc, ricoperti da una falda di dacron resinato da 200 gr/mq.

Poggiareni: densità 30 kg/mc. Termofalda da 350 gr/mq.

Spalliere poggiatesta: densità 23 kg/mc. Termofalda da 350 gr/mq.

Imbottiture di completamento: densità 21 kg/mc.

RIVESTIMENTO Pelle o microfibra non sfoderabile. Per le caratteristiche del rivestimento e della manutenzione vedere relative schede tecniche.

PIEDI A slitta in acciaio lucidato. H alla base del divano: cm 16,5

NOTE Gli schienali sono dotati di meccanismo manuale a cricchetto, reclinabili a seconda del comfort desiderato.

FRAME Hardwood combined with plywood and particle board.

PADDING Seat cushion, armrests, lumbar supports, backrests and headrests are made in polyurethane foam with varying density. All of the above parts are covers with a Dacron layer.

Seat cushions: upper part: 30 kg/m³ "soft comfort". Bottom part: 30 kg/m³ "normal comfort". Dacron layer 350 gr/m².

Armrest: Polyurethane foam 40 kg/m³ with completion parts in 21 kg/m³ covered in dacron 350 gr/m².

Lumbar support: 30 kg/m³. Dacron layer 350 gr/m².

Backs and headrests: 23 kg/m³. Dacron layer 350 gr/m².

Frame padding: 21 kg/m³

COVERING Leather or microfiber. Not removable. Please check covering details for care instructions.

FEET Shiny metal H 16,5 cm.

NOTE Headrests are equipped with manual adjustable mechanism.

STRUCTURE En bois, multiplies et particules habillées d'une couche de dacron.

REMBOURRAGE Coussins d'assise, accoudoirs, cales-reins, dossiers et appuie-tête en polyuréthane expansé à double densité. Toutes parties susdites sont recouvertes avec une couche de dacron.

Coussins d'assise : Partie supérieure polyuréthane expansé 30 kg/m³ (souple), partie inférieure polyuréthane expansé 30 kg/m³ portante. Dacron 350 gr/m².

Accoudoirs: Polyuréthane expansé 40 kg/m³ avec rembourrage de complément densité 21 kg/m³ recouvert en dacron 350 gr/m².

Cales-reins : 30 kg/m³. Dacron 350 gr/m².

Dossiers et appuie-tête : 23 kg/m³. Dacron 350/m².

Rembourrage de complément : densité 21 kg/m³.

REVETEMENT Cuir ou microfibra non déhoussable. Pour les caractéristique du revêtement aussi bien que pour l'entretien veuillez consulter les fiches techniques appropriés.

PIEDS En métal brillant, H 16,5 cm.

NOTES Les appuie-têtes sont équipé d'une mécanique manuelle à crémaillère.

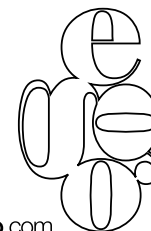
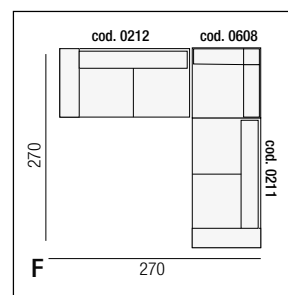
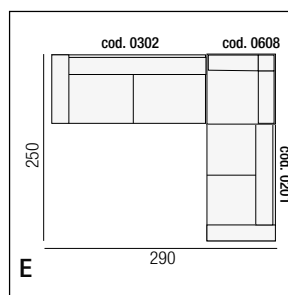
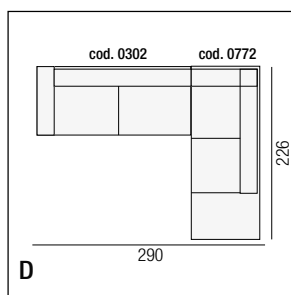
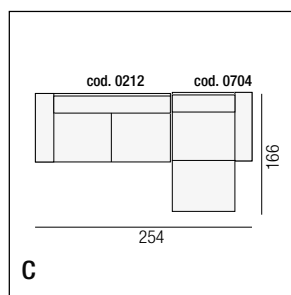
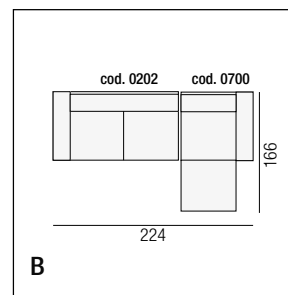
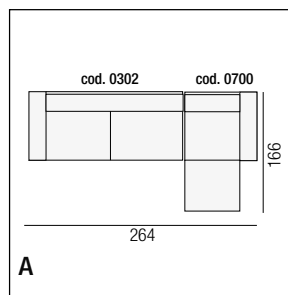
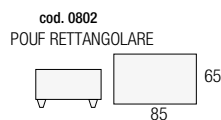
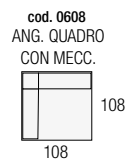
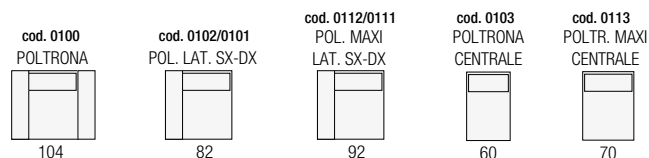
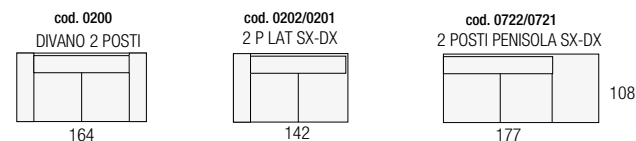
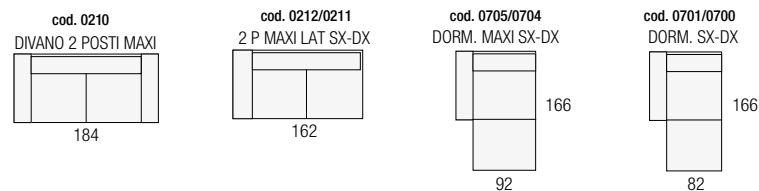
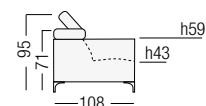
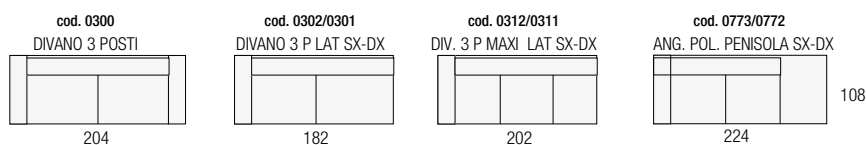

STRUTTURA Realizzata in legno abbinato a particelle di legno grezzo biodegradabile e pannelli di fibra di legno duro.

IMBOTTITURE Cuscini di seduta, braccioli, poggiatesta e spalliere poggiatesta reclinabili sono realizzate in poliuretano espanso. Tutte le parti sopraelencate sono ricoperte da una termofalda di dacron autoestinguente.

Cuscini di seduta: densità 30 kg/mc , ricoperti da una termofalda da 350 gr/mq.

Braccioli: densità 25 kg/mc. Termofalda da 350 gr/mq.

Poggiatesta: densità 25 kg/mc. Termofalda da 350 gr/mq.

Spalliere poggiatesta: densità 25 kg/mc. Termofalda da 350 gr/mq.

Imbottiture di completamento: densità 21 kg/mc.

RIVESTIMENTO Pelle o microfibra non sfoderabile. Per le caratteristiche del rivestimento e della manutenzione vedere relative schede tecniche.

PIEDI A slitta, in acciaio inox lucidato. H: cm 13

NOTE Nella versione relax il modello è dotato esclusivamente di meccanismo elettrico con comandi "touch sensor" posizionati immediatamente sotto il lato esterno del bracciolo o per le sedute centrali, montati a scomparsa sul lato interno della seduta. Gli elementi relax sono sempre staccati da quelli fissi e vengono agganciati con apposito sistema a baionetta. Il modello è dotato di cricchetti a scatto nelle testiere. L'inclinazione delle testiere può essere regolata manualmente a seconda del tipo di comfort desiderato.

FRAME Hardwood combined with plywood and particle board.

PADDING Seat cushion, armrests, lumbar supports and backrests-headrests are made in polyurethane foam. Every part mentioned is covered by a Dacron layer.

Seat cushions: Polyurethane foam 30 kg/m3 covered with a dacron layer 350 gr/m2.

Armrests: Polyurethane foam 25 kg/m3. Dacron layer 350 gr/m2.

Lumbar supports: Polyurethane foam 25 kg/m3. Dacron layer 350 gr/m2.

Backrests-headrests: Polyurethane foam 25 kg/m3. Dacron layer 350 gr/m2.

Frame padding: Polyurethane foam 21 kg/m3.

COVERING Leather or microfiber. Not removable. Please check covering details for care instructions.

FEET In polished steel. Feet height: 13 cm.

NOTE The relax version comes with electric movements only equipped with touch sensors. Controls are placed on the armrest side, whilst armless units carry

the touch sensor on the inside part of the seat. Elements with relax mechanism always delivered separately and connected to the fixed parts by made for purpose

bayonet fittings. Headrests inclination can be manually adjusted depending on the desired comfort.

STRUCTURE En bois, multiples et particules habillées d'une couche de dacron. **REMOURRAGE** Coussins d'assise, accoudoirs, cale reins et dossiers appui-tête en polyuréthane expansé. Toutes les parties indiquées sont couvertes par une couche de dacron.

Coussins d'assise: Polyuréthane 30 kg/m3, recouvert avec une couche en dacron 350 gr/m2.

Accoudoirs: Polyuréthane expansé 25 kg/m3 recouvert avec une couche de dacron 350 gr/m2.

Cale reins: Polyuréthane expansé 25 kg/m3 recouvert avec une couche de dacron 350 gr/m2.

Dossiers appui-tête: Polyuréthane expansé 25 kg/m3 recouvert avec une couche de dacron 350 gr/m2.

Rembouillage de complément : densité 21 kg/m3.

REVETEMENT Cuir ou microfibre non déhoussable. Pour les caractéristiques du revêtement aussi bien que pour l'entretien veuillez consulter les fiches techniques appropriées.

PIEDS En acier poli. Hauteur des pieds : 13 cm

NOTE En version relax le modèle est réalisé exclusivement avec relax électrique avec commande « touch » située sur la partie latérale extérieure de l'accoudoir, alors que les assises centrales sont équipées avec une pratique commande située à l'intérieur du coussin. Les éléments avec relax sont toujours séparés des

VERSIONI CON MECCANISMO RELAX AZIONABILE SOLO ELETTRICAMENTE.

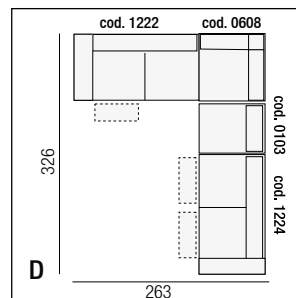
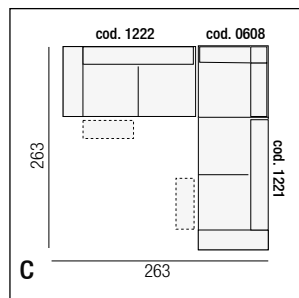
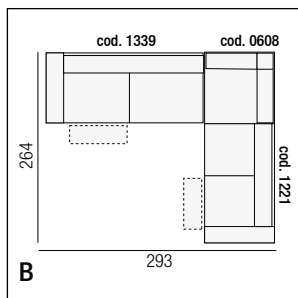
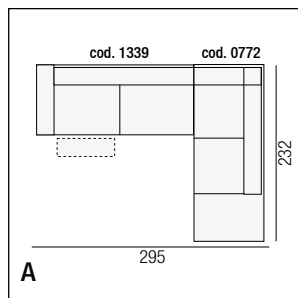
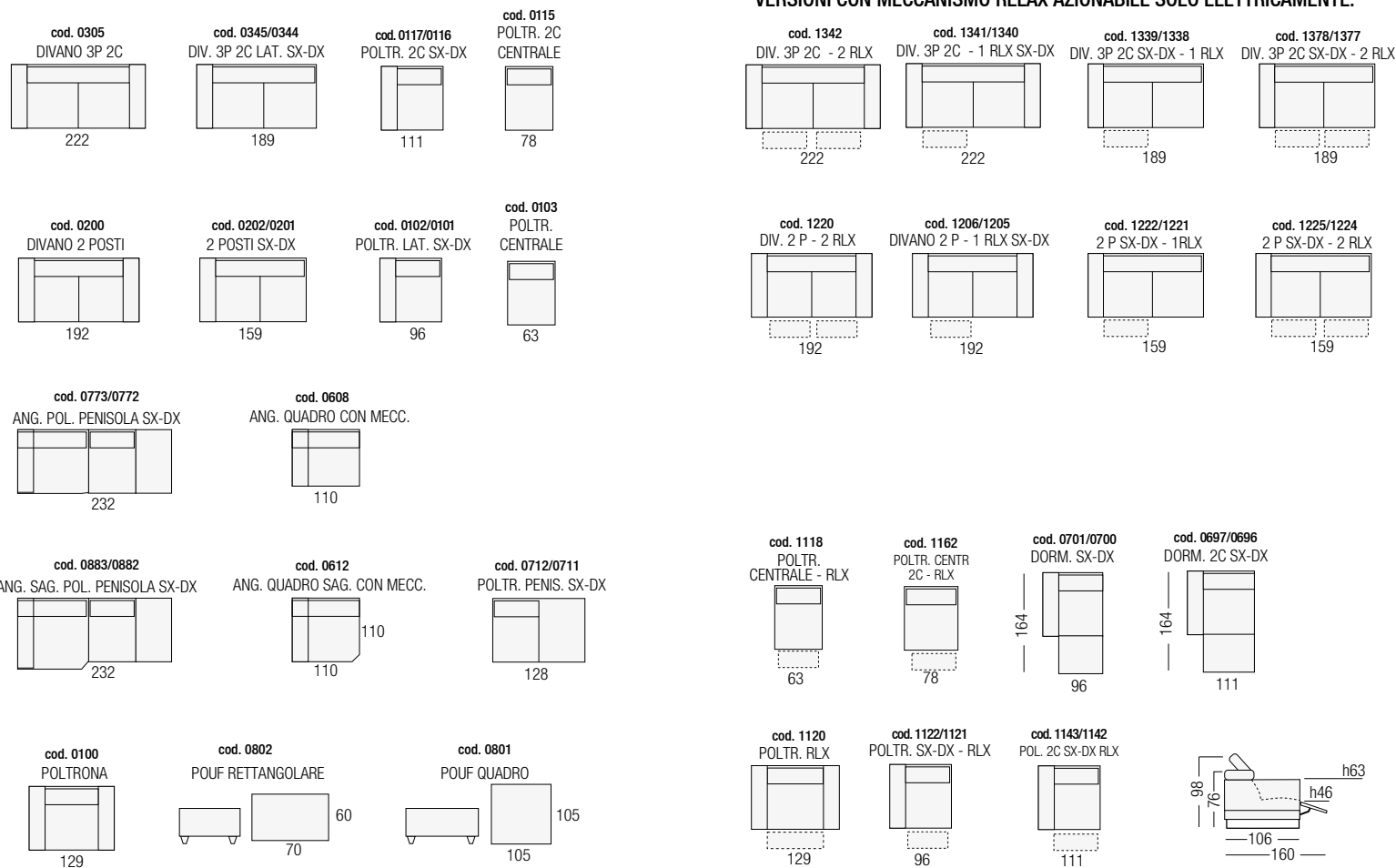

STRUTTURA Realizzata in legno abbinato a particelle di legno grezzo biodegradabile e pannelli di fibra di legno duro.

IMBOTTITURE Braccioli, poggiareni e spalliere poggiatesta reclinabili sono realizzate in poliuretano espanso a densità differenziate. Tutte le parti sopraelencate sono ricoperte da una termofalda di dacron autoestinguente. I cuscini di seduta sono realizzati con molle elicoidali insacchettate, posizionate tra due strati di poliuretano espanso.

Cuscini di seduta: strato superiore: densità 30 kg/mc. soffice. Strato inferiore: densità 30 kg/mc. portante. Termofalda da 350 gr/mq. All'interno dei cuscini di seduta è presente una sistema di molleggio realizzato con molle elicoidali insacchettate da cm. 8.

Braccioli e poggiareni: densità 25 kg/mc. Termofalda da 350 gr/mq.

Spalliere poggiatesta: densità 23 kg/mc. Termofalda da 350 gr/mq.

Imbottiture di completamento: densità 21 kg/mc.

RIVESTIMENTO Pelle o microfibra non sfoderabile. Per le caratteristiche del rivestimento e della manutenzione vedere relative schede tecniche.

PIEDI Slitta in tubolare d'acciaio lucidato a sezione rettangolare, H: cm 17

NOTE Gli schienali sono dotati di meccanismo manuale a cricchetto, reclinabili a seconda del comfort desiderato.

FRAME Hardwood combined with plywood and particle board.

PADDING Armrests, lumbar supports, backrests and headrests are made in polyurethane foam with varying density. All of the above parts are covers with a Dacron layer. Seat cushions are equipped with pocketed springs inserted between two layers of polyurethane foam.

Seat cushions: upper part: 30 kg/m3 "soft comfort". Bottom part: 30 kg/m3 "normal comfort". Dacron layer 350 gr/m2. Cushion are equipped with inner 8cm pocketed springs.

Armrest and lumbar supports: Polyurethane foam 25 kg/m3 covered in dacron 350 gr/m2.

Backs and headrests: 23 kg/m3. Dacron layer 350 gr(m2).

Frame padding: 21 kg/m3

COVERING Leather or microfiber. Not removable. Please check covering details for care instructions.

FEET Shiny metal H 17 cm.

NOTE Headrests are equipped with manual adjustable mechanism.

STRUCTURE En bois, multiples et particules habillés d'une couche de dacron.

REMBOURRAGE Accoudoirs, cales-reins, dossiers et appuie-tête en polyuréthane expansé à double densité. Toutes les parties susdites sont recouvertes avec une couche de dacron. Coussins d'assise réalisés avec ressorts

en sachets positionnées entre deux couches de polyuréthane expansé.

Coussins d'assise : Partie supérieure polyuréthane expansé 30 kg/m3 (souple), partie inférieure polyuréthane expansé 30 kg/m3 portante. Dacron 350 gr/m2. A l'intérieur des coussins il y a un système de ressorts en sachet de 8 cm.

Accoudoirs et cales-reins: Polyuréthane expansé 25 kg/m3 recouvert en dacron 350 gr/m2.

Dossiers et appuie-tête : 23 kg/m3. Dacron 350/m2.

Rembourrage de complément : densité 21 kg/m3.

REVETEMENT Cuir ou microfibre non déhoussable. Pour les caractéristique du revêtement aussi bien que pour l'entretien veuillez consulter les fiches techniques appropriés.

PIEDS En métal brillant, H 17 cm.

NOTES Les appuie-têtes sont équipé d'une mécanique manuelle à crémaillère.

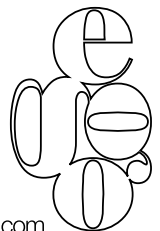
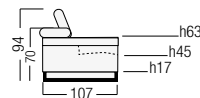
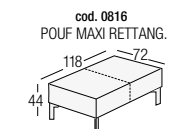
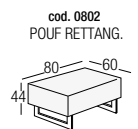
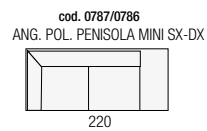
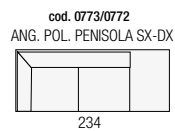
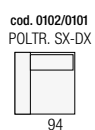
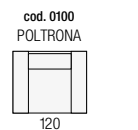
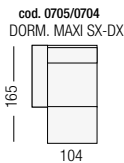
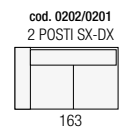
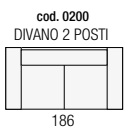
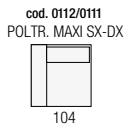
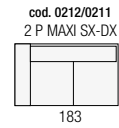
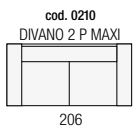
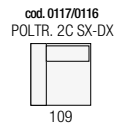
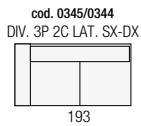
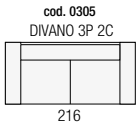
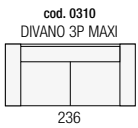

STRUTTURA Realizzata in legno abbinato a particelle di legno grezzo biodegradabile e pannelli di fibra di legno duro.

IMBOTTITURE Cuscini di seduta, braccioli, poggiatesta e spalliere poggiatesta reclinabili sono realizzate in poliuretano espanso a densità differenziate. Tutte le parti sopraelencate sono ricoperte da una termofalda di dacron autoestinguente. Cuscini di seduta: densità 30 kg/mc. Termofalda da 350 gr/mq.

Braccioli: densità 25 kg/mc. Termofalda da 350 gr/mq.

Spalliere e poggiatesta: densità 23 kg/mc. Termofalda da 350 gr/mq.

Imbottiture di completamento: densità 21 kg/mc.

RIVESTIMENTO Pelle o microfibra non sfoderabile. Per le caratteristiche del rivestimento e della manutenzione vedere relative schede tecniche.

PIEDI Struttura a slitta in acciaio con finitura cromata o titanio. H alla base del divano: cm 14

NOTE Il modello è dotato di un cricchetto nella testiera che permette di variarne l'inclinazione ed assecondare le più varie esigenze di comfort.

FRAME Hardwood combined with plywood and particle board.

PADDING Lumbar supports, backrests and headrests are made in polyurethane foam with varying density. Seat cushions: upper part: 30 kg/m3 "soft comfort". Bottom part: 30 kg/m3 "normal comfort". Dacron layer 350 gr/m2.

Backs and headrests: 23 kg/m3. Dacron layer 350 gr/m2.

Frame padding: 21 kg/m3

COVERING Leather or microfiber. Not removable. Please check covering details for care instructions.

FEET metal, chrome or titanium finish H 14 cm.

NOTE Headrests are equipped with manual adjustable mechanism.

STRUCTURE En bois, multiplies et particules habillés d'une couche de dacron.

REMBOURRAGE Cales-reins, dossiers et appuie-tête en polyuréthane expansé à double densité. Toutes les parties susdites sont recouvertes avec une couche de dacron.

Coussins d'assise : Partie supérieure polyuréthane expansé 30 kg/m3 (souple), Dacron 350 gr/m2.

Accoudoirs et cales-reins: Polyuréthane expansé 25 kg/m3 recouvert en dacron 350 gr/m2.

Rembourrage de complément : densité 21 kg/m3.

REVETEMENT Cuir ou microfibre non déhoussable. Pour les caractéristique du revêtement aussi bien que pour l'entretien veuillez consulter les fiches techniques appropriés.

PIEDS luge en acier avec du chrome ou de titane, H 14 cm.

NOTES Cliquet dans la tête de lit qui permet d'incliner et de répondre aux divers besoins de confort.

cod. 0300

DIVANO 3 POSTI



216

cod. 0302-0301

3 POSTI LAT. SX-DX



187

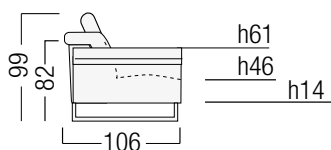

cod. 0210

DIVANO 2 P MAXI

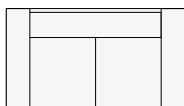

196

cod. 0212-211

2 P MAXI LAT. SX-DX

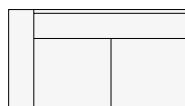

167

cod. 0773/0772

ANG. POL. PENISOLA SX-DX

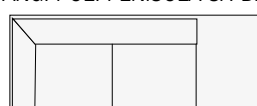

225

cod. 0705/0704

DORM. LAT. MAXI SX-DX

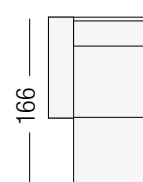

98

cod. 0200

DIVANO 2 POSTI



176

cod. 0202-0201

2 POSTI LAT. SX-DX



147

cod. 0100

POLTRONA

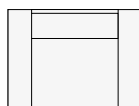

117

cod. 0699-0698

DIV. DORMOSA SX-DX

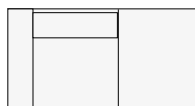

173

cod. 0802

POUF

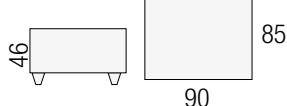

VERS. VANILLE 2

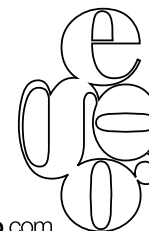

STRUTTURA Realizzata in legno abbinato a particelle di legno grezzo biodegradabile e pannelli di fibra di legno duro.

IMBOTTITURE Cuscino di seduta realizzato in poliuretano espanso di densità 30 kg/mc. Poggiatesta e poggiatesta di densità 30 kg/mc.

Seduta, poggiatesta e poggiatesta sono ricoperti da una termofalda di dacron autoestinguente da 350 gr/ mq. Braccioli di densità 30 kg/mc. ricoperti di dacron resinato da 200 gr/mq. Le imbottiture di completamento sono realizzate in poliuretano espanso di densità 21 kg/mc.

RIVESTIMENTO Pelle o microfibra non sfoderabile. Per le caratteristiche del rivestimento e della manutenzione vedere relative schede tecniche.

PIEDI La poltroncina è dotata di una base circolare realizzata in tubolare d'acciaio verniciato, ruotante a 360°, oppure di piedini in legno massello di faggio evaporato, verniciati nelle tinte bianco perla, grigio ombra, marrone scuro. H base /piedini: cm 5.

NOTE La poltroncina DILETTA è dotata di una testiera con cricchetti a snodo, regolabile a seconda del tipo di comfort desiderato.

FRAME Hardwood combined with plywood and particle board.

PADDING Seat cushion in polyurethane foam 30 kg/m3, with lumbar support area in foam density 23 kg/mc and head rest in foam density 23 kg/mc.

Seat cushion, lumbar support and headrest are covered with a layer of self extinguishing Dacron of 350 gr /sq m.

Armrest in polyurethane foam 30 kg/m3 covered with a layer of Dacron of 200 gr /sq m.

Frame padding: 21 kg/m3

COVERING Leather or microfiber. Not removable. Please check covering details for care instructions.

FEET The chair is equipped with a tubular steel circular base, swivelling at 360°, or on wooden feet colour pearl white, shadow grey o dark brown. H base / feet 5 cm.

NOTE Armchair Nanette is equipped with an adjustable headrest.

STRUCTURE En bois, multiples et particules habillés d'une couche de dacron.

REMBOURRAGE Coussin d'assise en polyuréthane expansé densité 30 kg/m3 avec cales-reins densité 23 kg/m3 et tête en densité 30 kg/mc. Assise, cales-reins et tête son couvert par une couche de dacron autoextinguible 350 gr/m2.

Accoudoirs en polyuréthane expansé densité 30 kg/m3 couvert par une couche de dacron autoextinguible 200 gr/m2.

Rembourrage de complément : densité 21 kg/m3.

REVETEMENT Cuir ou microfibre non déhoussable. Pour les caractéristique du revêtement aussi bien que pour l'entretien veuillez consulter la fiches techniques appropriés.

PIEDS Le fauteuil est équipé avec une base circulaire en tubulaire en acier peint, pivotant sur 360°, ou bien sur pieds en bois de hêtre coloris blanc perle, gris ombre ou marron foncé.

NOTE Le fauteuil Nanette est équipé d'un appui-tête réglable à crémaillère.

cod. 0123
POLTRONCINA GIREVOLE

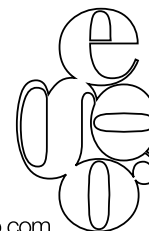
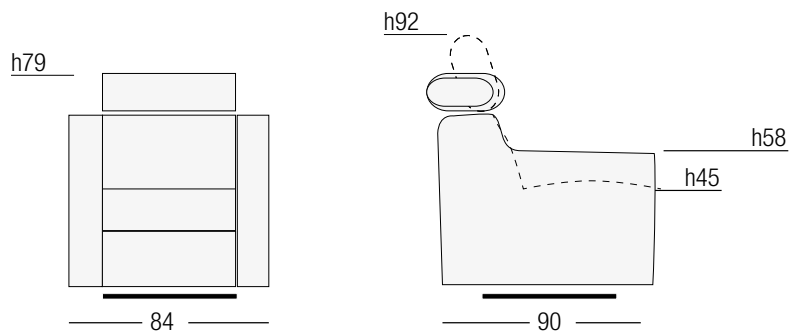

RIVESTIMENTO Pelle o microfibra non sfoderabile. Per le caratteristiche del rivestimento e della manutenzione vedere relative schede tecniche.
IMBOTTITURA Cuscini di seduta, braccioli, poggiatesta e spalliere poggiatesta reclinabili sono realizzate in poliuretano espanso a densità differenziate. Tutte le parti sopraelencate sono ricoperte da una termofalda di dacron autoestinguente. Cuscini di seduta: strato superiore: densità 30 kg/mc (soffice). Strato inferiore: densità 30 kg/mc (portante). Termofalda da 350 gr/mq. Braccioli: tampone superiore doppia densità 40 e 30 kg/mc. Termofalda da 350 gr/mq. Schienali realizzati in poliuretano espanso di densità 18 kg/mc, ricoperti da una falda di dacron da 350 gr/mq. Imbottiture di completamento: densità 21 kg/mc.
PIEDI In acciaio inox lucidato, H alla base del divano: cm 14,5
STRUTTURA Realizzata in legno abbinato a particelle di legno grezzo biodegradabile e pannelli di fibra di legno duro.

COVERING Leather, microfiber or fabric. Not removable.
PADDING Seat cushion, armrest, kidney rest and adjustable headrest: double density polyurethane foam covered with a Dacron layer.
 Seat cushion: upper part: 30kg/m3 "soft comfort". Bottom part: 30 kg/m3 "hard comfort". Dacron layer: 350 gr/m2. backrest cushion 18 kg/m3 covered with a Dacron layer.
FEET Polished stainless steel. Height 14,5 cm
FRAME Hardwood combined with plywood and particle board.

REVEITEMENT Cuir ou microfibre non déhoussable.
REMBOURRAGE Coussins d'assise, cale-reins, accoudoirs et appuie-tête réclinables réalisés en polyuréthane écologique à double densité recouvert avec une couche de dacron.
 Assise: Partie inferieure: 30 Kg/m3 (rigide). Partie superieure 30 Kg/m3 (souple). Couche de dacron 350 gr/m2. Accoudoirs: partie superieure double densité 40 et 30 Kg/m3. Dacron 350 gr/m2. Dossier en polyuréthane écologique densité 18 kg/mc habillé d'un couche de dacron. Rembourrage de complement: 21 Kg/m3
PIEDS Base en acier inox brillant, hauteur 14,5 cm
STRUCTURE En bois massif, multiplis et particules habillés d'une couche de dacron.

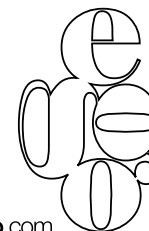
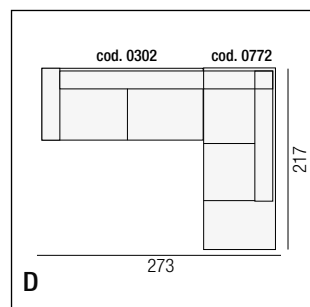
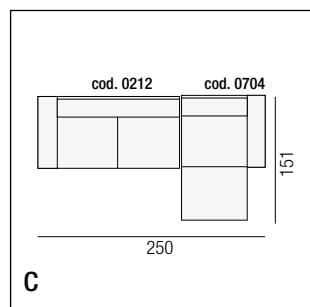
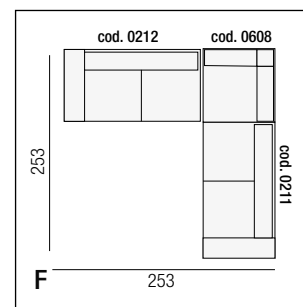
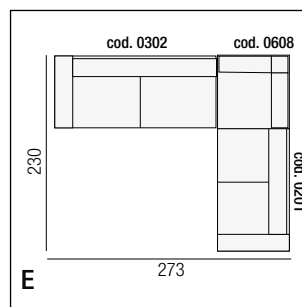
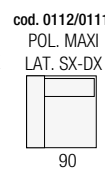
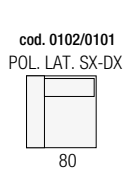
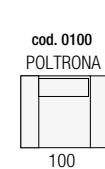
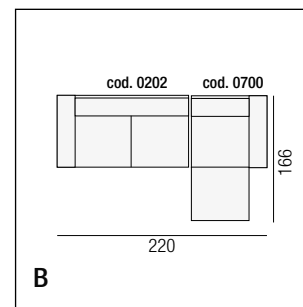
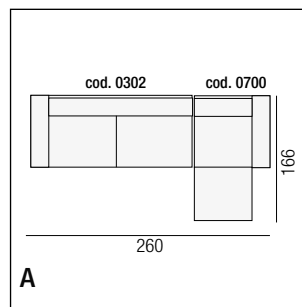
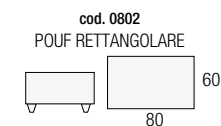
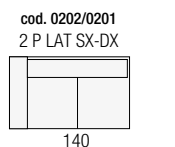
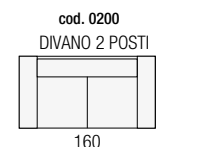
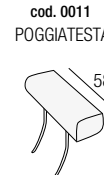
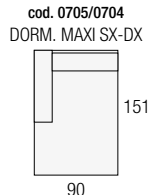
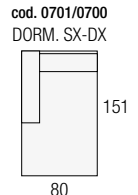
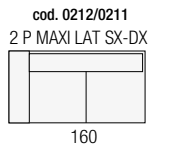
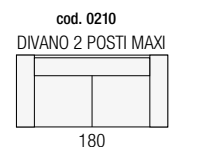
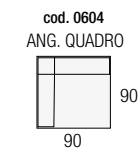
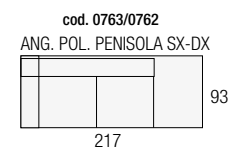
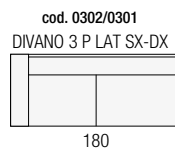
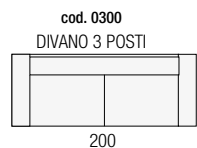
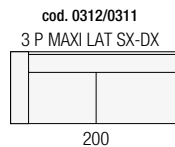
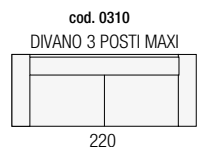
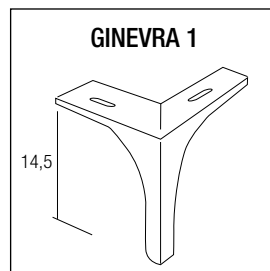
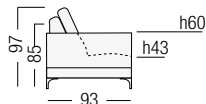
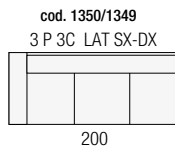
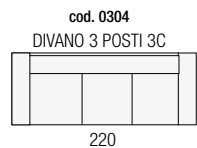

RIVESTIMENTO Pelle o microfibra non sfoderabile. Per le caratteristiche del rivestimento e della manutenzione vedere relative schede tecniche.
IMBOTTITURA Cuscini di seduta, braccioli, poggiatesta e schienali poggiatesta reclinabili sono realizzate in poliuretano espanso a densità differenziate. Tutte le parti sopraelencate sono ricoperte da una termofalda di dacron autoestinguente.
Cuscini di seduta: strato superiore: densità 30 kg/mc (soffice). Strato inferiore: densità 30 kg/mc (portante). Termofalda da 350 gr/mq. Braccioli: tampone superiore doppia densità 40 e 30 kg/mc. Termofalda da 350 gr/mq. Schienali realizzati in poliuretano espanso di densità 18 kg/mc, ricoperti da una falda di dacron da 350 gr/mq. Imbottiture di completamento: densità 21 kg/mc.
PIEDI In acciaio inox lucidato, H alla base del divano: cm 14,5
STRUTTURA Realizzata in legno abbinato a particelle di legno grezzo biodegradabile e pannelli di fibra di legno duro.

COVERING Leather, microfiber or fabric. Not removable.
PADDING Seat cushion, armrest, kidney rest and adjustable headrest: double density polyurethane foam covered with a Dacron layer.
Seat cushion: upper part: 30kg/m³ "soft comfort". Bottom part: 30 kg/m³ "hard comfort". Dacron layer: 350 gr/m². backrest cushion 18 kg/m³ covered with a Dacron layer.
FEET Polished stainless steel. Height 14,5 cm
FRAME Hardwood combined with plywood and particle board.

REVEITEMENT Cuir ou microfibre non déhoussable.
REMBOURRAGE Coussins d'assise, cale-reins, accoudoirs et appuie-tête réclinables réalisés en polyuréthane écologique à double densité recouvert avec une couche de dacron.
Assise: Partie inférieure: 30 Kg/m³ (rigide). Partie supérieure 30 Kg/m³ (souple). Couche de dacron 350 gr/m². Accoudoirs: partie supérieure double densité 40 et 30 Kg/m³. Dacron 350 gr/m². Dossier en polyuréthane écologique densité 18 kg/mc habillé d'une couche de dacron. Rembourrage de complément: 21 Kg/m³
PIEDS Base en acier inox brillant, hauteur 14,5 cm
STRUCTURE En bois massif, multiplis et particules habillés d'une couche de dacron.

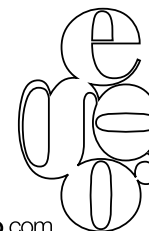
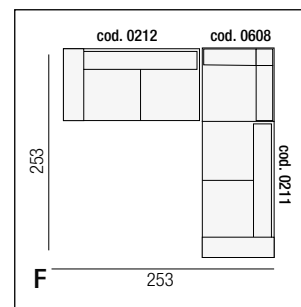
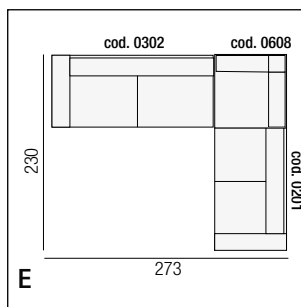
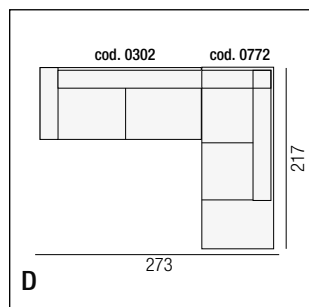
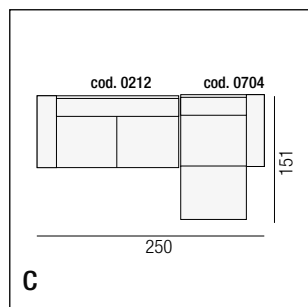
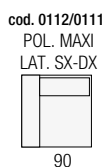
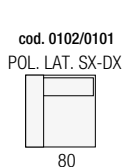
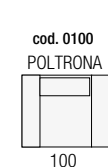
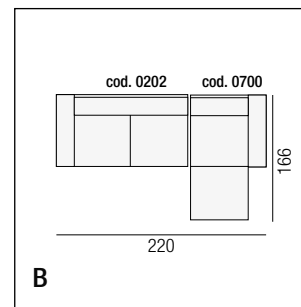
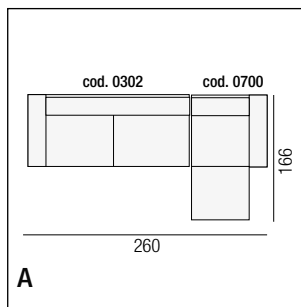
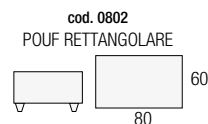
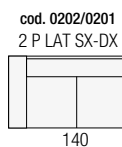
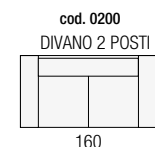
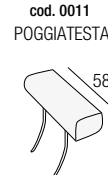
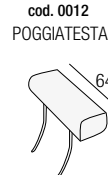
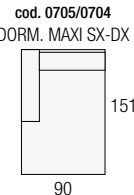
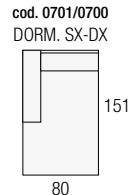
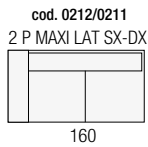
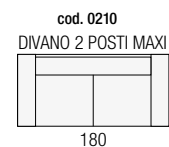
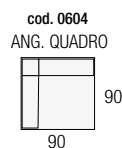
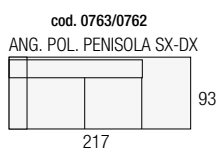
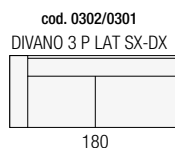
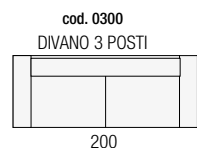
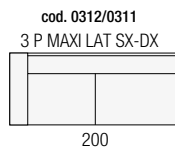
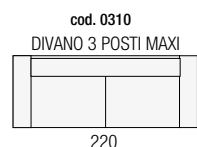
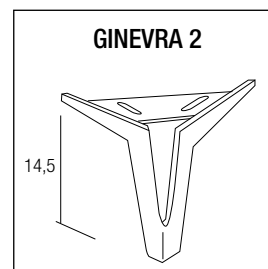
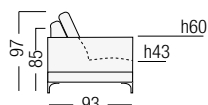
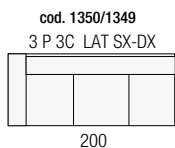
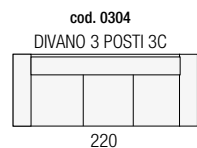

STRUTTURA Realizzata in legno abbinato a particelle di legno grezzo biodegradabile e pannelli di fibra di legno duro.

IMBOTTITURE Cuscini di seduta, braccioli, poggiatesta e spalliere poggiatesta reclinabili sono realizzate in poliuretano espanso. Tutte le parti sopraelencate sono ricoperte da una termofalda di dacron autoestinguente.

Cuscini di seduta a densità differenziata: parte superiore di densità 30 kg/mc soffice, parte inferiore di densità 30 kg/mc portante, ricoperti da una termofalda da 350 gr/mq.

Braccioli: densità 30 kg/mc. Termofalda da 350 gr/mq.

Poggiatesta: densità 25 kg/mc. Termofalda da 350 gr/mq.

Spalliere poggiatesta: densità 25 kg/mc. Termofalda da 350 gr/mq.

Imbottiture di completamento: densità 21 kg/mc.

RVESTIMENTO Pelle o microfibra non sfoderabile. Per le caratteristiche del rivestimento e della manutenzione vedere relative schede tecniche.

PIEDI In acciaio lucidato oppure in legno massello di faggio evaporato tinto con vernici ecologiche ad acqua, nei colori noce, noce brunito o wengè, oppure verniciati con tinte RAL coordinate con il rivestimento del modello.

NOTE Nella versione relax il modello è dotato esclusivamente di meccanismo elettrico con comando posizionato sul lato esterno del divano, mentre le sedute centrali sono dotate di un pratico telecomando. Gli elementi relax sono sempre staccati da quelli fissi e vengono agganciati con apposito sistema a baionetta. Nelle versioni fisse senza meccanismo relax in ogni caso è presente il cricchetto manuale nelle testiere.

FRAME Hardwood combined with plywood and particle board.

PADDING Seat cushion, armrests, lumbar supports and backrests-headrests are made in polyurethane foam. Every part mentioned is covered by a Dacron layer.

Seat cushions with varying density: Upper part 30 kg/m3 soft, bottom part 30 kg/m3 supporting. Dacron layer 350 gr/m2.

Armrests: Polyurethane foam 30 kg/m3. Dacron layer 350 gr/m2.

Lumbar supports: Polyurethane foam 25 kg/m3. Dacron layer 350 gr/m2.

Backrests-headrests: Polyurethane foam 25 kg/m3. Dacron layer 350 gr/m2.

Frame padding: Polyurethane foam 21 kg/m3.

COVERING Leather or microfiber. Not removable. Please check covering details for care instructions.

FEET In polished steel or in beech wood coloured with water based paint in wengè, walnut or dark walnut or in RAL colours combined with the covering.

NOTE The relax version comes with electric movements only. Controls are placed on the armrest side, whilst armless units are equipped with a remote control. Elements with relax mechanism always delivered separately and connected to the fixed parts by made for purpose bayonet fittings. Fixed versions are always equipped with mechanical headrests mechanism.

STRUCTURE En bois, multiples et particules habillés d'une couche de dacron.

REMBOURRAGE Coussins d'assise, accoudoirs, cale reins et dossiers appui-tête en polyuréthane expansé. Toutes les parties indiquées sont couvertes par une couche de dacron. Coussins d'assise à densité différenciée: Partie supérieure 30 kg/m3 souple, partie inférieure 30 kg/m3 portante. Couche en dacron 350 gr/m2.

Accoudoirs: Polyuréthane expansé 30 kg/m3 recouvert avec une couche de dacron 350 gr/m2.

Cale reins: Polyuréthane expansé 25 kg/m3 recouvert avec une couche de dacron 350 gr/m2. Dossiers appui-tête: Polyuréthane expansé 25 kg/m3 recouvert avec une couche de dacron 350 gr/m2.

Rembourrage de complément: densité 21 kg/m3.

REVETEMENT Cuir ou microfibre non déhoussable. Pour les caractéristiques du revêtement aussi bien que pour l'entretien veuillez consulter les fiches techniques appropriées.

PIEDS En acier poli ou en hêtre massif teinté avec vernis écologiques à base d'eau, dans les coloris wengès, noyer et noyer foncé ou bien avec des couleurs RAL combinées avec le revêtement.

NOTE En version relax le modèle est réalisé exclusivement avec relax électrique ayant sa commande située sur la partie latérale extérieure de l'accoudoir, alors que les assises centrales sont équipées avec une pratique télécommande. Les éléments avec relax sont toujours séparés des éléments fixes et reliés avec un système à baïonnette. Les versions fixes sans relax sont en tout cas toujours équipées avec mécanique à crémaillère des appui tête.

VERSIONI CON MECCANISMO RELAX AZIONABILE SOLO ELETTRICAMENTE.

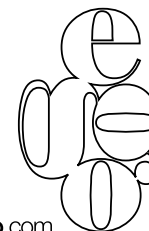
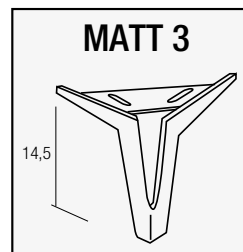
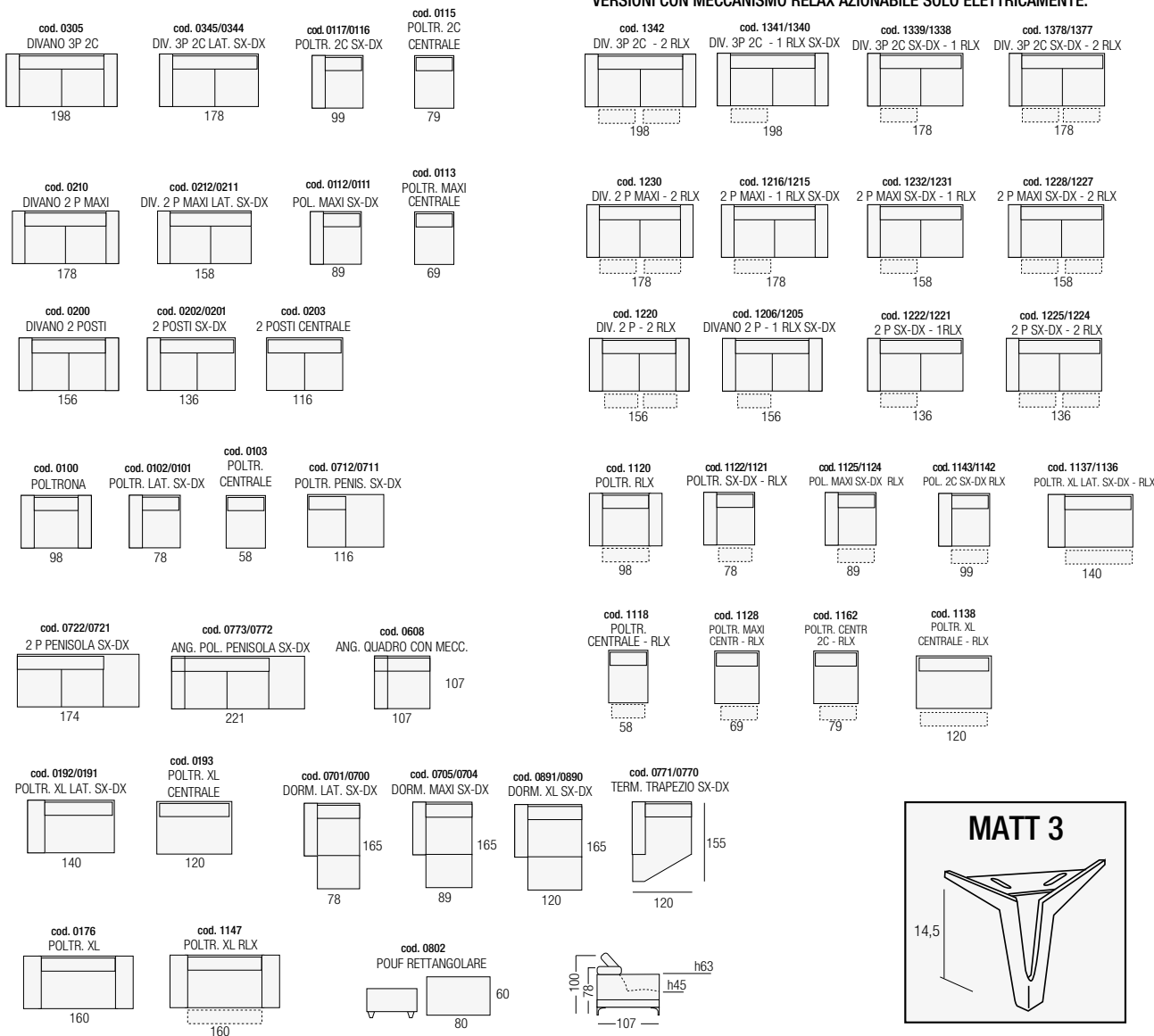

RIVESTIMENTO Pelle o microfibra non sfoderabile. Per le caratteristiche del rivestimento e della manutenzione vedere relative schede tecniche.

IMBOTTITURE Cuscini di seduta, braccioli e schienali sono realizzati in poliuretano espanso a densità differenziate, ricoperti da una termofalda di dacron autoestinguente.

Cuscini di seduta: densità 35 kg/mc. Termofalda da 350 gr/mq.

Braccioli : densità 30 kg/mc. Termofalda da 350 gr/mq.

Spalliere e poggiatesta : densità 25 kg/mc. Termofalda da 350 gr/mq.

Imbottiture di completamento: densità 21 kg/mc.

STRUTTURA Realizzata in legno abbinato a particelle di legno grezzo biodegradabile e pannelli di fibra di legno duro.

PIEDI realizzati in metallo nelle finiture cromo titanio o ottone spazzolato. H: cm 13

NOTE Il modello, sia nelle versioni relax che in quelle fisse, è dotato di schienali ad altezza variabile sino ad un massimo di cm 17, regolabili tramite motori elettrici posti all'interno del divano. I motori sono azionabili con semplici ed intuitivi pulsanti posti sui lati interni delle sedute.

Nelle versioni relax, con sedute dotate esclusivamente di motori elettrici, accanto ai pulsanti che agiscono sugli schienali, vi sono quelli che comandano la regolazione di apertura/chiusura della seduta.

Il movimento delle sedute è indipendente da quello degli schienali. Sedute e schienali motorizzati, con la loro azione combinata possono assecondare qualsiasi esigenza di comfort.

Tutti gli elementi, sia fissi che con meccanismo relax sono modulari ed assemblabili tra di loro per mezzo di appositi agganci a baionetta.

FRAME Hardwood combined with plywood and particle board.

PADDING Seat cushion, armrests and backrests are made in polyurethane foam with varying density. All of the above parts are covered with a Dacron layer.

Seat cushions: Polyurethane foam 35 kg/m3. Dacron layer 350 gr/m2.

Armrests: Polyurethane foam 30 kg/m3. Dacron layer 350 gr/m2.

Backrests and Lumbar supports: 25 kg/m3. Dacron layer 350 gr/m2.

Frame padding: 21 kg/m3

COVERING Leather or microfiber. Not removable. Please check covering details for care instructions.

FEET In metal available either in titanium finish or brushed brass. H 13 cm.

NOTE The model is always equipped with variable height backrests up to a maximum of 17 cm, adjustable by electric motors located inside the sofa. The engines can be operated with simple and intuitive buttons located on the inner sides of the seats.

Relax versions have seats fitted with electric motors only, and its controls are placed next to the buttons that act on the backrests.

The seats movement is independent of that of the backrests. Motorized seats and backs, with their combined action can satisfy any need of comfort.

All the elements, both fixed and with relax mechanism, are modular and can be assembled by means of a bayonet fixing hook.

STRUCTURE En bois, multiples et particules habillées d'une couche de dacron.

REMBOURRAGE Coussins d'assise, accoudoirs, et dossiers en polyuréthane expansé à double densité. Toutes parties susdites sont recouvertes avec une couche de dacron.

Coussins d'assise : Polyuréthane expansé 35 kg/m3. Dacron 350 gr/m2.

Accoudoirs : Polyuréthane expansé 35 kg/m3. Dacron 350 gr/m2.

Dossiers et Cales-reins : 30 kg/m3. Dacron 350 gr/m2.

appui-tête : Polyuréthane expansé 25 kg/m3. Dacron 350/m2.

Rembourrage de complément : densité 21 kg/m3.

REVETEMENT Cuir ou microfibre non déhoussable. Pour les caractéristiques du revêtement aussi bien que pour l'entretien veuillez consulter les fiches techniques appropriés.

PIEDS En métal disponible dans les couleurs Titane ou Cuivre brossé, H 13 cm.

NOTES Le modèle, en version relax ou en version fixe, est équipé de dossiers ayant une hauteur variable jusqu'à un maximum de 17 cm, réglable par des moteurs électriques situés à l'intérieur du canapé. Les moteurs peuvent être actionnés par des boutons simples et intuitifs situés sur les côtés intérieurs des assises.

Dans les versions relax, les assises sont équipés uniquement avec des moteurs électriques, à côté des boutons qui agissent sur les dossiers, il ya ceux qui contrôlent le réglage de l'ouverture / fermeture de l'assise.

Le mouvement des assises est indépendant de celui des dossiers. Assises et dossiers motorisés, avec leur action combinée peuvent satisfaire toutes les exigences de confort.

Tous les éléments, à la fois fixe et avec un mécanisme de relaxation sont modulaires et peuvent être assemblés entre eux au moyen d'un crochet de fixation à baïonnette.

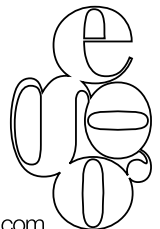
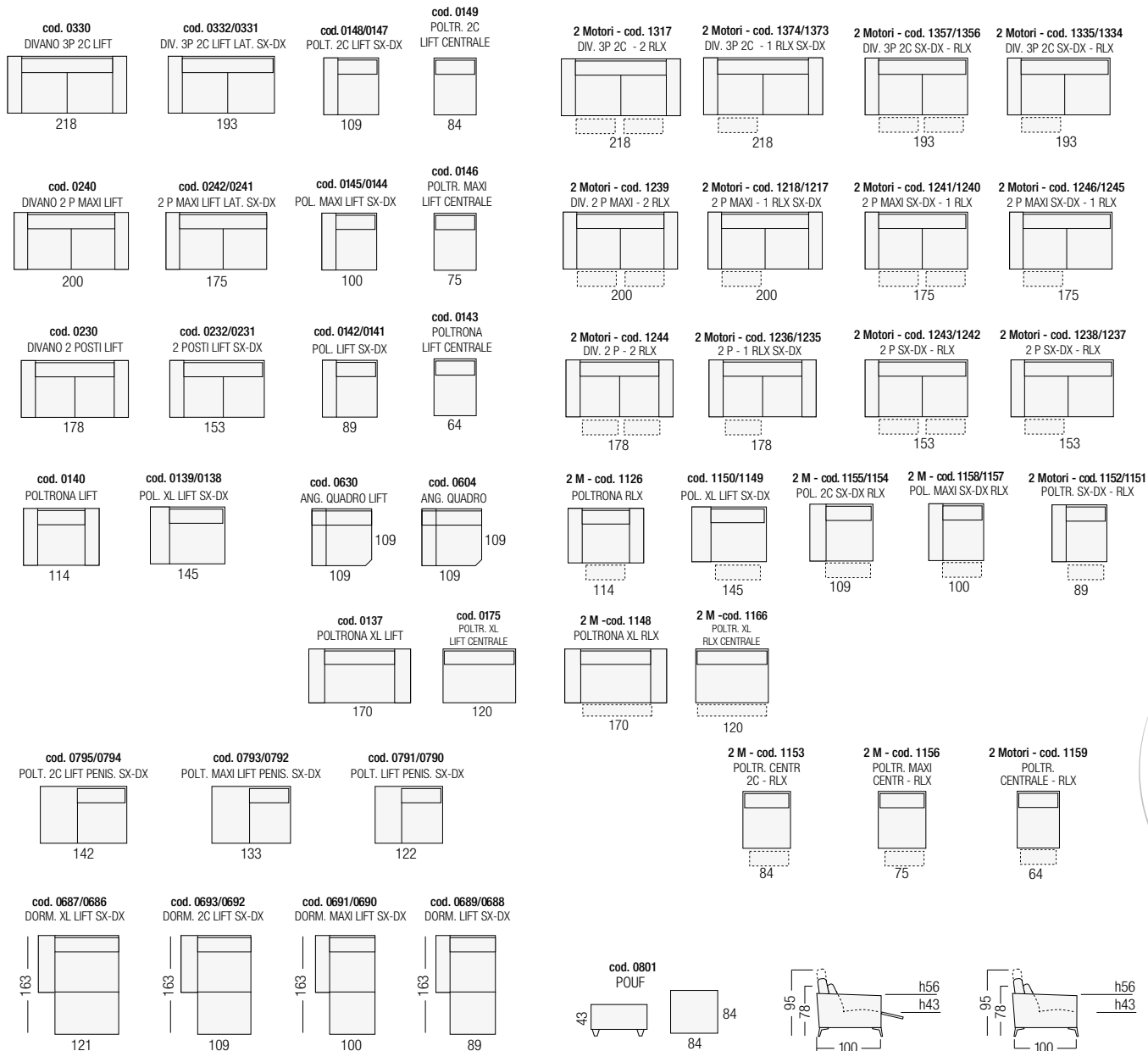

N.B. LE SEDUTE SENZA MOTORE RELAX DEVONO ESSERE

RIVESTIMENTO Pelle o microfibra non sfoderabile. Per le caratteristiche del rivestimento e della manutenzione vedere relative schede tecniche.
IMBOTTITURE Cuscino schienale realizzato in poliuretano espanso di densità 25 kg/mc. Cuscino di seduta realizzato in poliuretano espanso di densità 35 kg/mc. Braccioli realizzati in poliuretano espanso di densità 40 kg/mc. Schienale e seduta sono ricoperti entrambi da una termofalda di dacron autoestinguente da 350 gr/ mq. Le imbottiture di completamento sono realizzate in poliuretano espanso di densità 40 kg/mc. e ricoperte da una falda di dacron resinato da 200 gr/mq.
STRUTTURA Realizzata in legno abbinato a particelle di legno grezzo biodegradabile e pannelli di fibra di legno duro.
PIEDI La poltroncina è montata su una coppia di sostegni a vista, realizzati in legno massello di rovere. Tali sostegni sono disponibili nelle colorazioni rovere naturale o rovere noce canaletto. H alla base della poltroncina: cm 28.

COVERING Leather or microfiber. Not removable. Please check covering details for care instructions.

PADDING Backrests are made in polyurethane foam, density 25 Kg. Seat cushions are made in polyurethane foam, density 35 kg. Armrests are made in polyurethane foam, density 40 Kg. All of the above parts are covered with a Dacron layer.

Frame padding: 40 kg/m3

FRAME Hardwood combined with plywood and particle board.

FEET The model is mounted on two visible solid oak supports, available in the colors; natural oak or walnut canaletto. H to the base of the chair: 28 cm

REVETEMENT Cuir ou microfibre non déhoussable. Pour les caractéristique du revêtement aussi bien que pour l'entretien veuillez consulter les fiches techniques appropriés.

REMBOURRAGE Dossiers en mousse de polyuréthane expansé densité 25 Kg. Assises en mousse de polyuréthane expansé à densité 35 kg. Accoudoirs en mousse de polyuréthane expansé à densité 40 kg. Dossiers et assises sont recouvertes avec une couche de dacron 350gr.

Rembourrage de complément en mousse de polyuréthane expansé à densité 40 kg/m3 et recouvertes par une couche de dacron 200gr.

STRUCTURE En bois combiné avec des particules de bois et panneaux de fibre de bois .

PIEDS Le fauteuil est montée sur deux soutiens visibles, réalisés en chêne massif disponibles dans les couleurs chêne naturel ou noyer canaletto. H à la base du fauteuil: 28 cm.

cod. 0164
POLTRONCINA

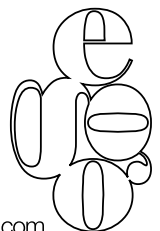
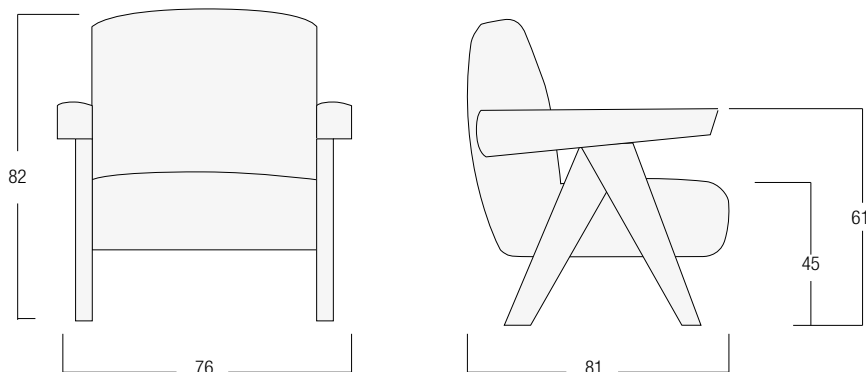

IMBOTTITURE Braccioli e schienali sono realizzati in poliuretano espanso. I cuscini di seduta sono realizzati in poliuretano espanso a densità differenziata con un inserto centrale composto da molle elicoidali. Tutte le parti sopraelencate sono ricoperte da una termofalda di dacron autoestinguente.

Cuscini di seduta: parte superiore di densità 35 kg/mc. Parte inferiore di densità 40 kg/mc. Termofalda da 350 gr/mq. Inserto con molle elicoidali per ogni seduta.

Braccioli: densità 30 kg/mc. Termofalda da 350 gr/mq.

Schienali: densità 23 kg/mc. Termofalda da 350 gr/mq.

Imbottiture di completamento: densità 21 kg/mc.

RIVESTIMENTO Pelle o microfibra non sfoderabile. Per le caratteristiche del rivestimento e della manutenzione vedere relative schede tecniche.

PIEDI Il modello è caratterizzato da una struttura portante realizzata in legno massello di rovere, nelle colorazioni rovere naturale o rovere noce canaletto. La struttura è corredata di basette realizzate in metallo, aventi funzione di piedini. Tali basette sono disponibili nella finitura ottone spazzolato e su richiesta nella finitura titanio. H alla base del divano: cm 13.

STRUTTURA Realizzata in legno abbinato a particelle di legno grezzo biodegradabile e pannelli di fibra di legno duro.

NOTE Gli schienali sono dotati di meccanismo manuale a cricchetto, reclinabili a seconda del comfort desiderato.

FRAME Hardwood combined with plywood and particle board.

PADDING Armrests and backrests are made in polyurethane foam. Seat cushions are made in polyurethane foam with varying density and central core with coil springs. All of the above parts are covered with a Dacron layer.

Seat cushions: Upper part in Polyurethane foam 35 kg/m3. Lower part in Polyurethane foam 40 kg/m3. Dacron layer 350 gr/m2. Coil springs central insert on each seat cushion.

Armrests: Polyurethane foam 30 kg/m3. Dacron layer 350 gr/m2.

Backrests: 23 kg/m3. Dacron layer 350 gr/m2.

Frame padding: 21 kg/m3

COVERING Leather or microfiber. Not removable. Please check covering details for care instructions.

FEET The model is characterized by a structure made of solid oak, available in the colors; natural oak or walnut canaletto. The structure is accompanied by metal whiskers functioning as feet. These feet are available in brushed brass finish and on demand in titanium finish. H to the base of the sofa: 13 cm.

NOTE Backrests are equipped with a manual adjustable mechanism, allowing to attain the desired comfort.

STRUCTURE En bois, multiples et particules habillés d'une couche de dacron.

REMBOURRAGE Accoudoirs et dossiers en mousse de polyuréthane expansé. Assises en mousse de polyuréthane expansé à densité différenciée ayant partie centrale avec ressorts hélicoïdaux. Toutes parties susdites sont recouvertes avec une couche de dacron.

Coussins d'assise : Partie supérieure en polyuréthane expansé 35 kg/m3. Partie inférieure en polyuréthane expansé 40 kg/m3. Dacron 350 gr/m2. Chaque assise avec partie centrale avec ressorts hélicoïdaux.

Coussins d'assise : Partie supérieure en polyuréthane expansé 35 kg/m3. Partie inférieure en polyuréthane expansé 40 kg/m3. Dacron 350 gr/m2. Chaque assise avec partie centrale avec ressorts hélicoïdaux.

Accoudoirs: Polyuréthane expansé 30 kg/m3. Dacron 350 gr/m2.

Dossiers: Polyuréthane expansé 23 kg/m3. Dacron 350 gr/m2.

Rembourrage de complément : densité 21 kg/m3.

REVETEMENT Cuir ou microfibre non déhoussable. Pour les caractéristique du revêtement aussi bien que pour l'entretien veuillez consulter les fiches techniques appropriés.

PIEDS Le modèle est caractérisé par une structure en chêne massif, dans les couleurs chêne naturel ou noyer canaletto. La structure et finie par des pieds en métal. Les pieds en métal sont disponibles en finition cuivre brossé et sur demande en finition titane. H à la base du canapé: 13 cm.

NOTES Les dossiers sont équipé avec un mécanisme manuel, inclinable selon le confort souhaité.

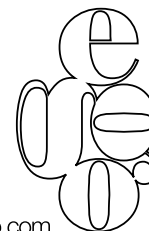
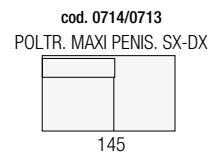
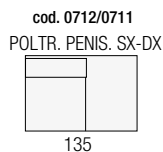
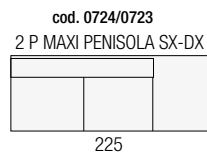
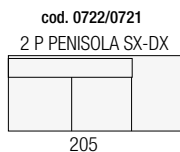
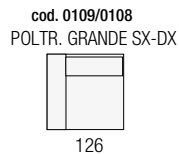
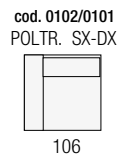
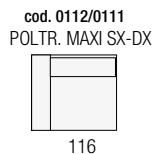
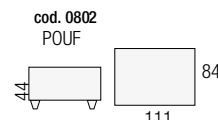
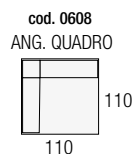
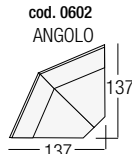
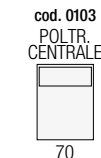
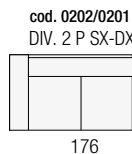
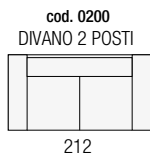
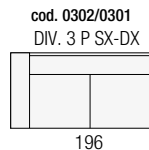
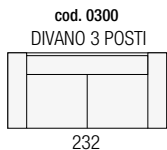
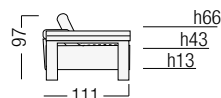
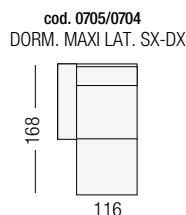
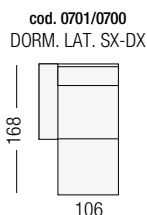
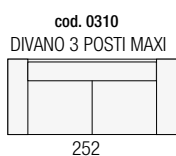

STRUTTURA Realizzata in legno abbinato a particelle di legno grezzo biodegradabile e pannelli di fibra di legno duro.

IMBOTTITURE Cuscino schienale realizzato in poliuretano espanso di densità 23 kg/mc. Cuscino di seduta realizzato in poliuretano espanso di densità 35 kg/mc. Schienale e seduta sono ricoperti entrambi da una termofalda di dacron autoestingente da 350 gr/ mq. Le imbottiture di completamento sono realizzate in poliuretano espanso di densità 21 kg/mc. e ricoperte da una falda di dacron resinato da 200 gr/mq.

RIVESTIMENTO Pelle o microfibra non sfoderabile. Per le caratteristiche del rivestimento e della manutenzione vedere relative schede tecniche.

PIEDI La poltroncina è sorretta da una coppia di braccioli in legno massello di rovere, aventi anche funzione di piedi e sono corredati da basette in metallo disponibili nella finitura ottone spazzolato o, solo su richiesta, in finitura titanio. I braccioli possono essere richiesti nelle finiture rovere naturale e rovere noce canaletto.

FRAME Hardwood combined with plywood and particle board covered by a layer of polyurethane foam.

PADDING Backrests are made in polyurethane foam 23kg/m3. Seat cushion in polyurethane foam density 35 Kg/m3. All the above parts are covered by a layer of Dacron 350gr/m2. Frame padding in polyurethane foam density 21 kg/m2 covered in Dacron 200 gr/m2.

COVERING Leather or microfiber. Not removable. Please check covering details for care instructions.

FEET The chair is characterized by solid oak armrests functioning as feet. They are finished with metal feet available in brushed copper finish and on demand in titanium finish. The armrests are available in the colors natural oak or walnut canaletto.

STRUCTURE En bois, multiplies et particules habillés d'une couche de polyuréthane expansé.

REMBOURRAGE Dossier en mousse de polyuréthane expansé 23Kg/mc. Assise en mousse de polyuréthane expansé 35Kg/mc. Toutes parties sont couvertes par une couche de dacron 350gr/m2.

Rembourrage de complément en polyuréthane expansé 21Kg/mc recouvert par du dacron 200gr/m2.

REVETEMENT Cuir ou microfibre non déhoussable. Pour les caractéristique du revêtement aussi bien que pour l'entretien veuillez consulter les fiches techniques appropriés.

PIEDS Le fauteuil est caractérisé par des accoudoirs en chêne massif ayant fonction de pieds. Ils sont finis par des pieds en métal disponibles en finition cuivre brossé et sur demande en finition titane. Les accoudoirs sont disponibles dans les couleurs chêne naturel ou noyer canaletto.

cod. 0164
POLTRONCINA

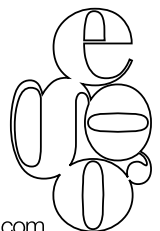
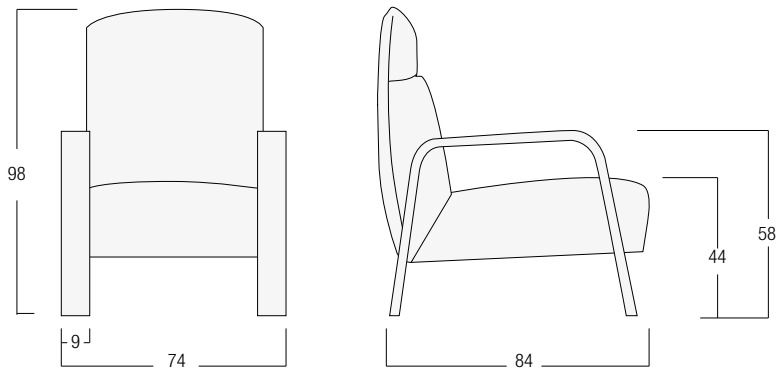

STRUTTURA Realizzata in legno abbinato a particelle di legno grezzo biodegradabile e pannelli di fibra di legno duro.

IMBOTTITURE Cuscini di seduta, braccioli, poggiatesta e spalliere poggiatesta reclinabili sono realizzate in poliuretano espanso. Tutte le parti sopraelencate sono ricoperte da una termofalda di dacron autoestinguente.

Cuscini di seduta a densità differenziata: parte superiore di densità 30 kg/mc soffice, parte inferiore di densità 30 kg/mc portante, ricoperti da una termofalda da 350 gr/mq. Braccioli: densità 40 kg/mc. con completamenti da 21 kg/mc, ricoperti da una falda di dacron resinato da 200 gr/mq.

Poggiatesta: densità 25 kg/mc. Termofalda da 350 gr/mq.

Spalliere poggiatesta: densità 25 kg/mc. Termofalda da 350 gr/mq.

Imbottiture di completamento: densità 21 kg/mc.

RIVESTIMENTO Pelle o microfibra non sfoderabile. Per le caratteristiche del rivestimento e della manutenzione vedere relative schede tecniche.

PIEDI A slitta in metallo, nelle finiture: cromato, ottone spazzolato o titanio. H alla base del divano: cm 13

NOTE Nella versione relax il modello è dotato esclusivamente di meccanismo elettrico con comando posizionato sul lato interno del divano, mentre le sedute centrali sono dotate di comandi "touch sensor" posti sul fianco interno della seduta. Gli elementi relax sono sempre staccati da quelli fissi e vengono agganciati con apposito sistema a baionetta. In tutte le versioni, sia fisse che relax, è presente il cricchetto nelle testiere che è regolabile manualmente e permette di creare l'assetto ideale a seconda del tipo di comfort desiderato.

FRAME Hardwood combined with plywood and particle board.

PADDING Seat cushion, armrests, lumbar supports, backrests and headrests are made in polyurethane foam with varying density. All of the above parts are covers with a Dacron layer.

Seat cushions: upper part: 30 kg/m³ "soft comfort". Bottom part: 30 kg/m³ "rigid comfort". Dacron layer 350 gr/m².

Armrest: Polyurethane foam 40 kg/m³ with completion parts in 21 kg/m³ covered in dacron 200 gr/m².

Lumbar support: 25 kg/m³. Dacron layer 350 gr/m².

Backs and headrests: 25 kg/m³. Dacron layer 350 gr/m².

Frame padding: 21 kg/m³

COVERING Leather or microfiber. Not removable. Please check covering details for care instructions.

FEET In metal available in chrome finish, brushed brass or titanium. H 13 cm.

NOTE when with recliner seats, the model is always equipped electric mechanisms with control panel on the inside part of the armrest. The central seats, when recliner, are equipped with "touch sensor" buttons placed on the seat side. Recliner elements are always detached from fixed elements and can be assembled by means of a bayonet fixing hook.

Headrests are always equipped with manual adjustable mechanism.

STRUCTURE En bois, multiples et particules habillées d'une couche de dacron.

REMBOURRAGE Coussins d'assise, accoudoirs, et dossiers en polyuréthane expansé à double densité. Toutes parties susdites sont recouvertes avec une couche de dacron.

REMBOURRAGE Coussins d'assise, accoudoirs, cales-reins, dossiers et appuie-tête en polyuréthane expansé à double densité. Toutes parties susdites sont recouvertes avec une couche de dacron.

Coussins d'assise : Partie supérieure polyuréthane expansé 30 kg/m³ (souple), partie inférieure polyuréthane expansé 30 kg/m³ portante. Dacron 350 gr/m².

Accoudoirs : Polyuréthane expansé 40 kg/m³ avec rembourrage de complément densité 21 kg/m³ recouvert en dacron 200 gr/m².

Cales-reins : 25 kg/m³. Dacron 350 gr/m².

Dossiers et appuie-tête : 25 kg/m³. Dacron 350 gr/m².

Rembourrage de complément : densité 21 kg/m³.

RETEMENT Cuir ou microfibre non déhoussable. Pour les caractéristiques du revêtement aussi bien que pour l'entretien veuillez consulter les fiches techniques appropriés.

PIEDS En métal disponible dans les finitions chrome, cuivre brossé ou titane, H 13 cm.

NOTES Dans les versions relax, les assises sont équipées uniquement avec des moteurs électriques avec commandes situées sur le côté interne des accoudoirs, alors que les assises centrales sont équipées avec des boutons « touch sensor » placés sur côté interne de l'assise. Les éléments ave relax sont toujours séparés et peuvent être assemblés entre eux au moyen d'un crochet de fixation à baionnette.

Toute version est toujours équipée d'un mécanisme de réglage des têtes manuel qui permet de trouver la position de confort souhaité.

VERSIONI CON MECCANISMO RELAX AZIONABILE SOLO ELETTRICAMENTE.

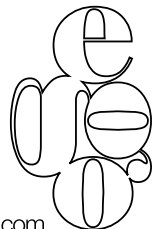
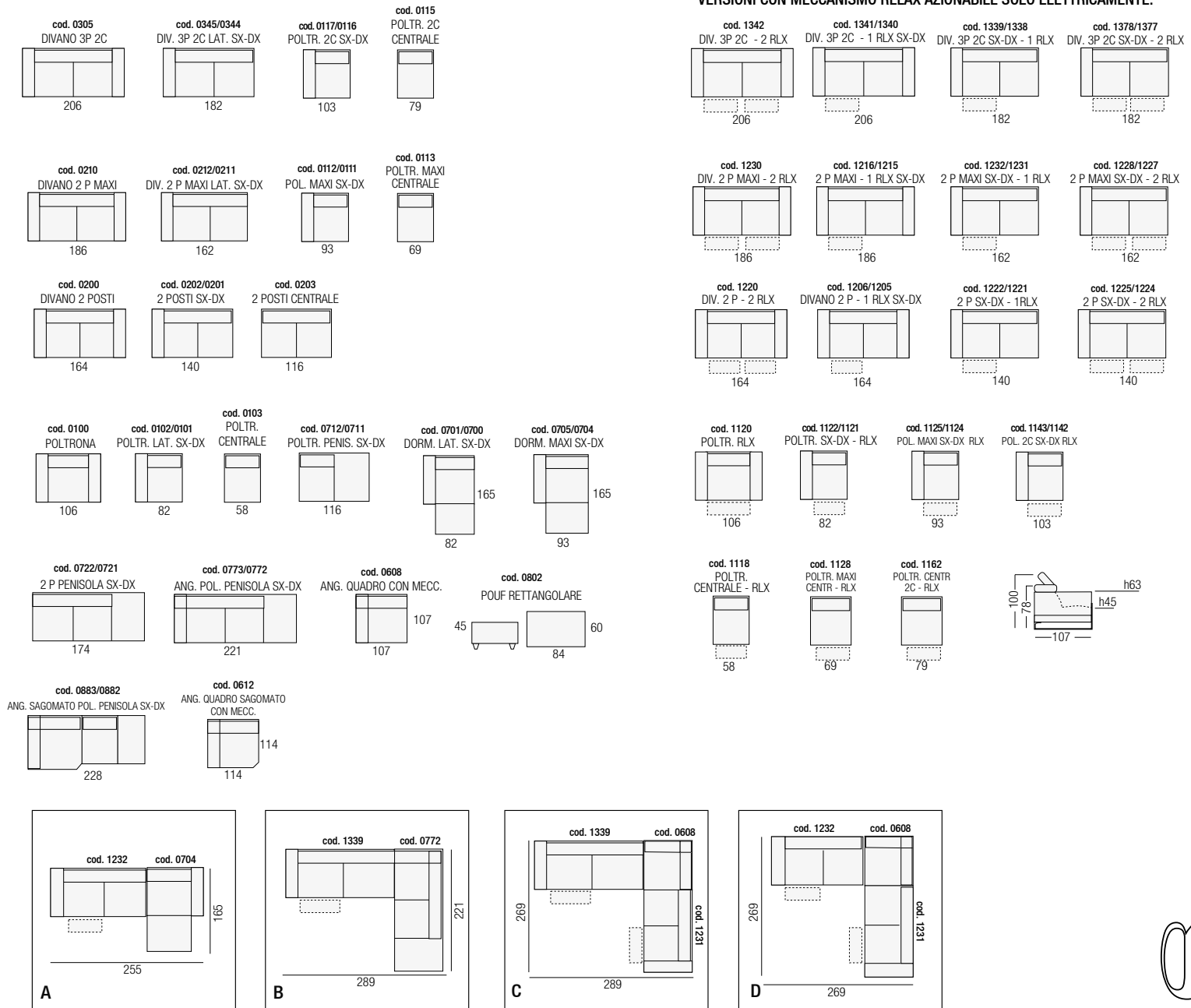

STRUTTURA Realizzata in legno abbinato a particelle di legno grezzo biodegradabile e pannelli di fibra di legno duro.

IMBOTTITURE Cuscino schienale realizzato in poliuretano espanso di densità 30 kg/mc. con zona poggiatesta di densità 23 kg/mc. Cuscino di seduta realizzato in poliuretano espanso di densità 30 kg/mc. Schienale e seduta sono ricoperti entrambi da una termofalda di dacron autoestinguente da 350 gr/ mq. Le imbottiture di completamento sono realizzate in poliuretano espanso di densità 21 kg/mc.

RIVESTIMENTO Pelle o microfibra non sfoderabile. Per le caratteristiche del rivestimento e della manutenzione vedere relative schede tecniche.

PIEDI la poltroncina poggia su una base girevole a stella e misura cm 19 in altezza e cm 60 di diametro. E' possibile richiedere la base realizzata nelle finiture: acciaio lucidato, titanio, ottone spazzolato.

FRAME Hardwood combined with plywood and particle board covered by a layer of polyurethane foam.

PADDING Backrests are made in polyurethane foam 30kg/m3 with lumbar support with density 23 kg/m3. Seat cushion in polyurethane foam density 30 Kg/m3. All the above parts are covered by a layer of Dacron 350gr/m2. Frame padding in polyurethane foam density 21 kg/m2.

COVERING Leather or microfiber. Not removable. Please check covering details for care instructions.

FEET The chair is characterized by a star shaped swivel base measuring 19 cm height and 60cm of diameter. The base is available in shiny chrome finish, titanium or brushed bras.

STRUCTURE En bois, multiples et particules habillés d'une couche de polyuréthane expansé.

REMBOURRAGE Dossier en mousse de polyuréthane expansé 30Kg/mc avec cales reins densité 23Kg/mc. Assise en mousse de polyuréthane expansé 30Kg/mc. Toutes parties sont couvertes par une couche de dacron 350gr/m2. Rembourrage de complément en polyuréthane expansé 21Kg/mc.

REVETEMENT Cuir ou microfibre non déhoussable. Pour les caractéristique du revêtement aussi bien que pour l'entretien veuillez consulter les fiches techniques appropriés.

PIEDS Le fauteuil est caractérisé par une base pivotante en forme d'étoile ayant 19cm d'hauteur et 60 cm de diamètre. La base est disponible dans les finitions acier brillant, titane et cuivre brossé.

cod. 0123
POLTRONCINA GIREVOLE

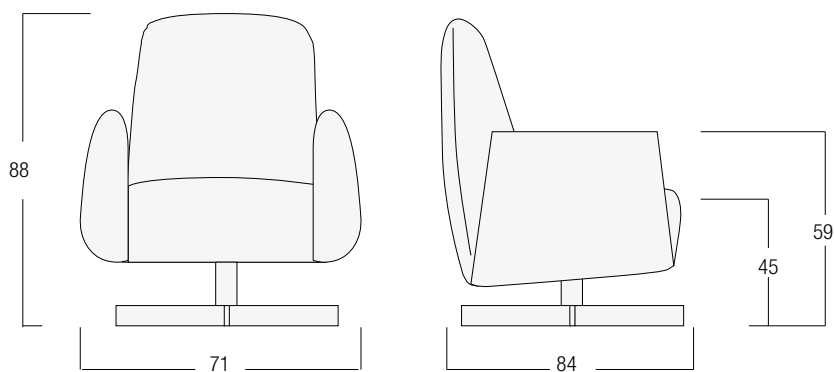

cod. 0133
POLTRONA BERGÈRE GIREVOLE

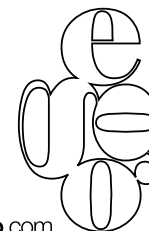
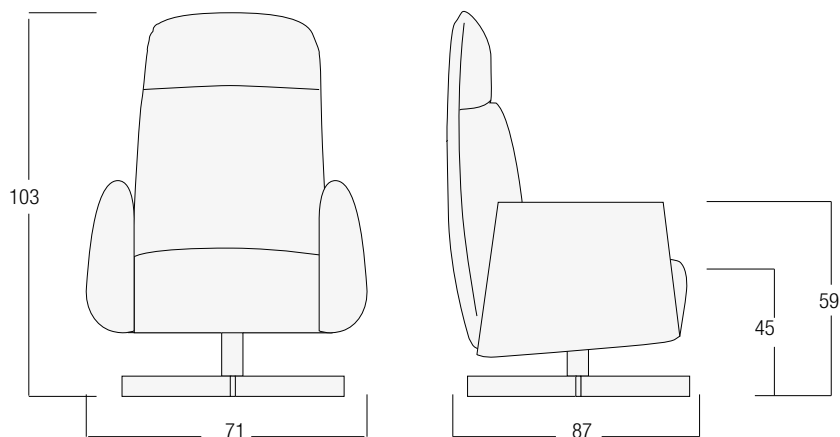

STRUTTURA Realizzata in legno abbinato a particelle di legno grezzo biodegradabile e pannelli di fibra di legno duro.

IMBOTTITURE Cuscini di seduta, braccioli, poggiatesta e schienali reclinabili sono realizzate in poliuretano espanso. Tutte le parti sopraelencate sono ricoperte da una termofalda di dacron autoestinguente. Cuscini di seduta a densità differenziata: parte superiore di densità 30 kg/mc soffice, parte inferiore di densità 35 kg/mc portante, ricoperti da una termofalda da 350 gr/mq.

Braccioli: densità 35 kg/mc. Termofalda da 350 gr/mq.

Poggiatesta: densità 25 kg/mc. Termofalda da 450 gr/mq.

Spalliere poggiatesta: densità 25 kg/mc. Termofalda da 450 gr/mq.

Imbottiture di completamento: densità 21 kg/mc.

RIVESTIMENTO Pelle o microfibra, non sfoderabile. Per le caratteristiche del rivestimento e della manutenzione vedere relative schede tecniche.

PIEDI In legno massello di faggio evaporato con profilo in metallo, tinto con vernici ecologiche ad acqua, nei colori wengé, noce brunito, noce. H: cm. 5.

NOTE Gli schienali sono dotati di meccanismo manuale a cricchetto, reclinabili a seconda del comfort desiderato.

le versioni letto sono dotate di reti a due pieghe elettrosaldate, realizzate in acciaio ad alta resistenza, verniciate a forno con polveri epossidiche.

Reti: divano 3 posti: 180x201; divano 2 posti maxi: 160x201; 2 posti: 140x201; poltrona: 90x201.

Materassi: in poliuretano espanso divano 3 posti: 160x196x16; divano 2 posti

maxi: 140x196x16; divano 2 posti: 120x196x16; poltrona: 70x196x16.

FRAME Hardwood combined with plywood and particle board.

PADDING Seat cushion, armrests, lumbar supports and backrests-headrests are made in polyurethane foam. Every part mentioned is covered with a layer of self extinguishing dacron.

Seat cushions with varying density: Upper part 35 kg/m3 soft, bottom part 35 kg/m3 supporting. Dacron layer 350 gr/m2.

Armrests: Polyurethane foam 30 kg/m3 with part in density 40 kg/m3. Dacron layer 400 gr/m2.

Lumbar supports: Polyurethane foam 25 kg/m3. Dacron layer 450 gr/m2.

Backrests-headrests: Polyurethane foam 25 kg/m3. Dacron layer 450 gr/m2.

Frame padding: Polyurethane foam 21 kg/m3.

COVER Leather not removable. Fabric or microfiber fully removable. Please check covering details for care instructions.

FEET In polished steel or in beech wood coloured wengé, walnut or dark walnut. H 5 cm.

NOTE Bed versions are equipped with two folds electro-welded bed mechanisms made of steel painted with epoxy powder finishes baked.

Mechanisms: 3 seater 180x201; 2 seater maxi 160x201; Armchair 90x201.

Mattress : in polyurethane foam 3 seater 160x193x16; 2 seater maxi 140x193x16 ; 2 seater 120x193x16 ; Armchair 70x193x16.

STRUCTURE En bois, multiples et particules habillés d'une couche de dacron.

REMBOURRAGE Coussins d'assise, accoudoirs, cale reins et dossiers appui-tête en polyuréthane expansé.

Toutes les parties indiquées sont couvertes par une couche de dacron autoextinguible.

Coussins d'assise à densité différenciée: Partie supérieure 35 kg/m3 souple, partie inférieure 35 kg/m3 portante. Couche en dacron 350 gr/m2.

Accoudoirs: Polyuréthane expansé 30 kg/m3 avec parties en densité 40 kg/mc recouvert avec une couche de dacron 400 gr/m2.

Cale reins: Polyuréthane expansé 25 kg/m3 recouvert avec une couche de dacron 450 gr/m2.

Dossiers appui-tête: Polyuréthane expansé 25 kg/m3 recouvert avec une couche de dacron 450 gr/m2.

Rembourrage de complément : densité 21 kg/m3.

REVETEMENT Cuir non déhoussable. Microfibre ou tissu déhoussable. Pour les caractéristiques du revêtement aussi bien que pour l'entretien veuillez consulter les fiches techniques appropriées.

PIEDS En acier poli ou en hêtre massif teinté wengés, noyer ou noyer foncé. H 5 cm.

NOTE Les versions lit sont équipées avec sommier deux plis électro-soudé, réalisé en acier à haute résistance, peint avec des poudres époxy au four.

Sommiers : 3 places 180 x 201 ; 2 places maxi 160 x 201 ; 2 places 140 x 201 ; Fauteuil 90 x 201.

Matelas : en polyuréthane 3 places 160x193x16; 2 places maxi 140x193x16 ; 2 places 120x193x16 ; Fauteuil 70x193x16.

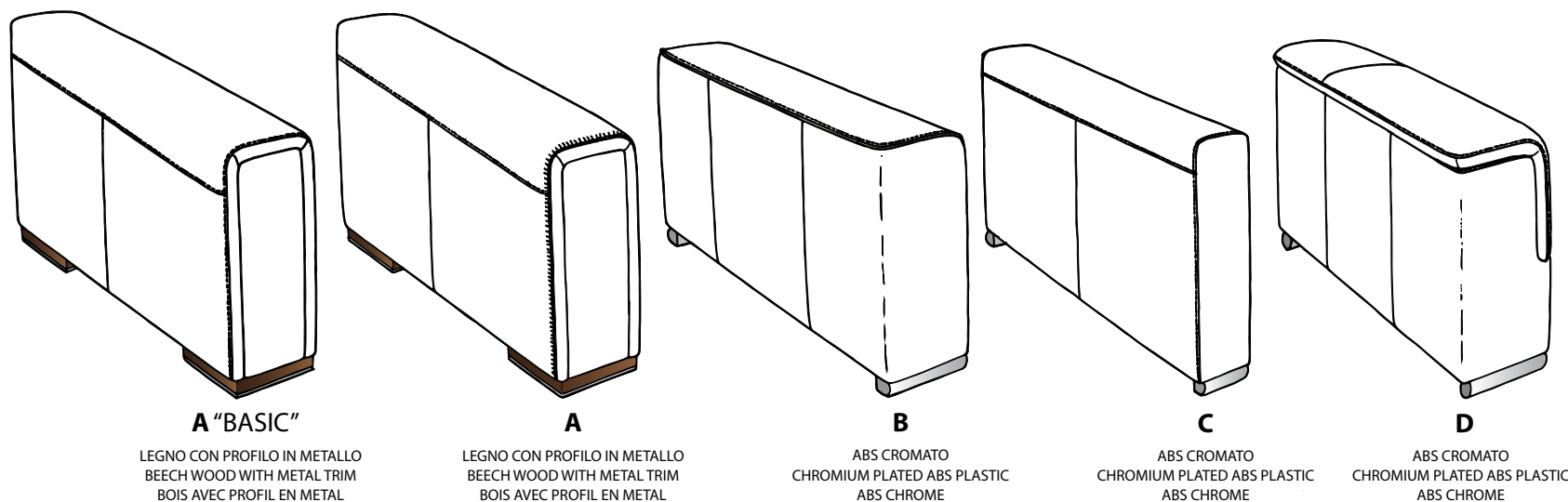

A "BASIC"

LEGGNO CON PROFILO IN METALLO
BEECH WOOD WITH METAL TRIM
BOIS AVEC PROFIL EN METAL

A

LEGGNO CON PROFILO IN METALLO
BEECH WOOD WITH METAL TRIM
BOIS AVEC PROFIL EN METAL

B

ABS CROMATO
CHROMIUM PLATED ABS PLASTIC
ABS CHROME

C

ABS CROMATO
CHROMIUM PLATED ABS PLASTIC
ABS CHROME

D

ABS CROMATO
CHROMIUM PLATED ABS PLASTIC
ABS CHROME

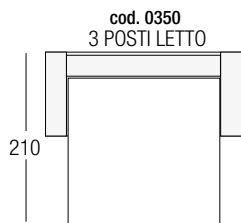

cod. 0350
3 POSTI LETTO



cod. 0260
2 POSTI MAXI LETTO



cod. 0250
2 POSTI LETTO



cod. 0150
POLTRONA LETTO

"A Basic" - "A" - "B" version	232	212	192	142
"C" version	216	196	176	126
"D" version	234	214	194	144

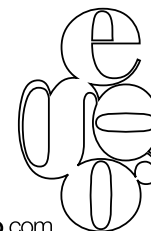
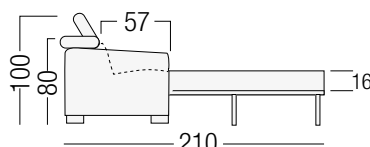
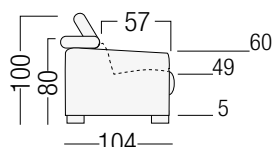

RIVESTIMENTO Pelle o microfibra non sfoderabile. Per le caratteristiche del rivestimento e la manutenzione vedere relative schede tecniche.

IMBOTTITURA Cuscini di seduta e braccioli in poliuretano espanso ecologico a densità differenziata. Cuscini di seduta di densità 30 kg/mc ricoperti con falda di dacron resinato da 100 gr/mq. Cuscini schienali realizzati in fibra di poliestere siliconata in fiocchi. Braccioli di densità 22 Kg/mc ricoperti da una termofalda di dacron autoestinguente da 350 gr/mq.

PIEDI In Legno massello di faggio evaporato tinto con vernici ecologiche ad acqua, nei colori: Noce brunito, Wengè. H 4 cm.

STRUTTURA Realizzata in legno abbinato a particelle di legno grezzo biodegradabile e pannelli di fibra di legno duro.

RETE due pieghe elettrosaldata (3 POSTI 150x186), (2 P MAX 120x186).

MATERASSO a molle, optional in poliuretano espanso (3 POSTI 130x180x12), (2 P MAX 100x180x12).

NOTE Nella versione relax il modello è realizzato con meccanismo combinato con movimento schienale poggiatesta. Disponibile sia manuale che elettrico con comando posizionato sul bracciolo laterale. L'elemento relax è sempre staccato da quello fisso e viene agganciato con apposito sistema a baionetta.

COVERING Leather, microfiber or fabric. Not removable.

PADDING Ecologic polyurethane foam.

Seat cushion 30kg/m3 covered with a dacron layer 100gr/m2

Armrest 22kg/m3 covered with dacron layer 350gr/m2

Backrest cushion: siliconed polyester fibre

FEET Beech feet color dark walnut, wengè. H4cm

FRAME Hard wood combined with plywood and particle board covered with a dacron layer.

BASE Electro-welded 2-ply (3 seater 150x186cm, 2 seater maxi 120x186cm)

MATTRESS Spring, polyurethane on demand (3 seater 130x180x12cm, 2 seater maxi 100x180x12cm)

NOTE Manual and electric recliner available.

REVETEMENT Cuir, microfibre ou tissu non déhoussable.

REMBOURRAGE Coussins d'assise et accoudoirs: polyuréthane écologique à densité différenciée. Coussins d'assise: 30kg/m3 recouverts d'une couche de Dacron résiné 100gr/m2. Dossiers: flocons de mousse. Accoudoirs: densité 22kg/m3 recouverts d'une couche de dacron 350gr/m2.

PIED hêtre massif, vernis écologiques: noyer bruni ou Wengé. H 4cm.

STRUCTURE Bois recouvert d'une couche de dacron.

SOMMIER Electro-soudé à 2 plis (3 places 150x186, 2p.max 120x186).

MATELAS À ressorts, sur demande en polyuréthane (3 places 130x180x12, 2p.max 100x180x12).

NOTE Dans la version relax le modèle est réalisé avec un mécanisme combiné dossier/repose-pieds. Disponible en manuel ou électrique avec commande sur l'accoudoir. L'élément relax est toujours détaché du fixe et est attaché à ce dernier par un système spécifique à baionnette.

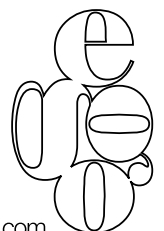
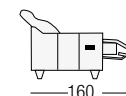
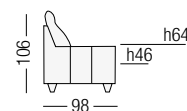
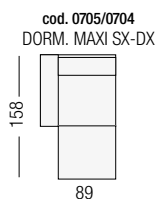
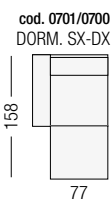
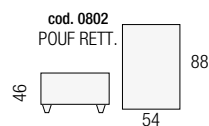
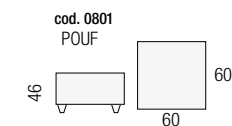
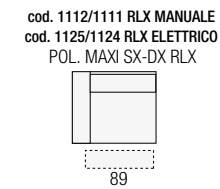
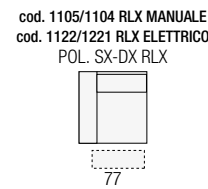
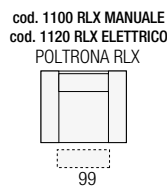
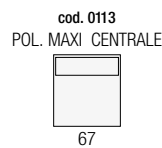
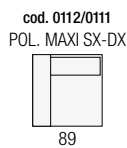
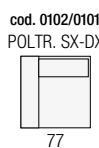
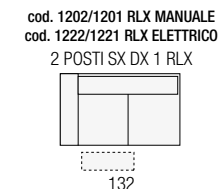
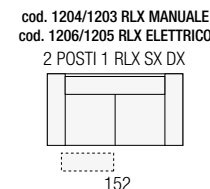
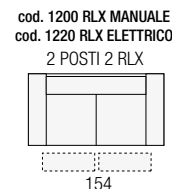
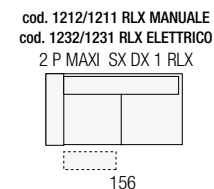
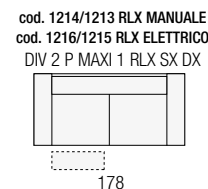
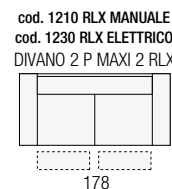
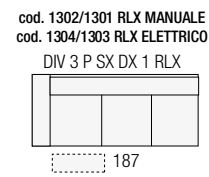
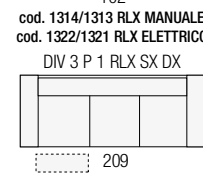
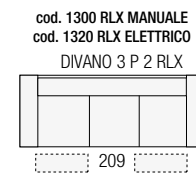
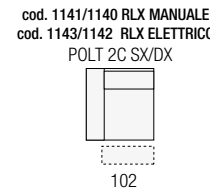
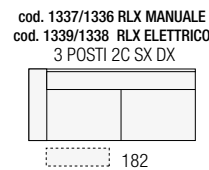
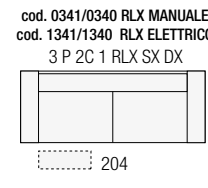
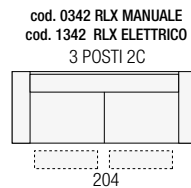
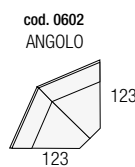
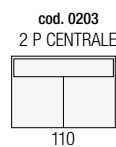
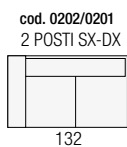
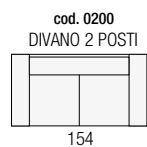
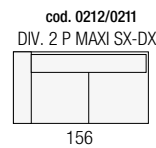
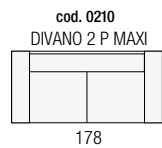
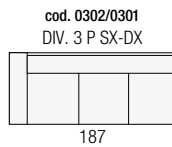
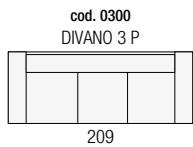
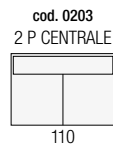
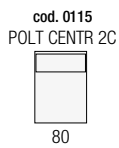
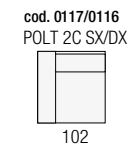
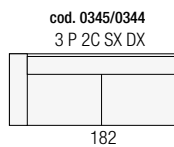
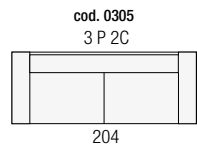

STRUTTURA Realizzata in legno abbinato a particelle di legno grezzo biodegradabile e pannelli di fibra di legno duro.

IMBOTTITURE Braccioli, poggiatesta e spalliere poggiatesta reclinabili sono realizzate in poliuretano espanso a densità differenziate. Tutte le parti sopraelencate sono ricoperte da una termofalda di dacron autoestinguente. Cuscini di seduta: strato superiore: densità 30 kg/mc. soffice. Strato inferiore: densità 35 kg/mc. portante. Tampono anteriore: densità 40 kg/mc. Falda in dacron resinato da 100 gr/mq.

Braccioli: densità 30 kg/mc. Termofalda da 350 gr/mq.

Poggiatesta: densità 25 kg/mc. Termofalda da 350 gr/mq.

Spalliere poggiatesta: densità 25 kg/mc. Termofalda da 350 gr/mq.

Imbottiture di completamento: densità 21 kg/mc.

RIVESTIMENTO Pelle o microfibra non sfoderabile. Per le caratteristiche del rivestimento e della manutenzione vedere relative schede tecniche.

PIEDI Slitta in tubolare d'acciaio a sezione rettangolare, H: cm 17. Disponibili nelle finiture: cromato, ottone spazzolato, titanio.

NOTE Gli schienali ed i braccioli sono dotati di meccanismo manuale a cricchetto, reclinabili a seconda del comfort desiderato.

I braccioli, grazie agli speciali cricchetti a frizione di cui sono dotati, possono essere riportati in posizione di chiusura semplicemente premendo verso il basso.

Il modello può essere corredato con il nuovo Sofaudio39x, che permette di trasformare il vostro divano in uno straordinario elemento Hi-Tech, ideale per ascoltare musica o ricaricare i vostri dispositivi mobili.

FRAME Hardwood combined with plywood and particle board.

PADDING Armrests, lumbar supports, backrests and headrests are made in polyurethane foam with varying density. All of the above parts are covered with a Dacron layer.

Seat cushions: upper part: 30 kg/m3 "soft comfort". Bottom part: 35 kg/m3 "hard comfort". Front pad: 40 kg/m3. Dacron layer 100 gr/m2.

Armrests: Polyurethane foam 30 kg/m3 covered in dacron 350 gr/m2.

Lumbar supports: Polyurethane foam 25 kg/m3 covered in dacron 350 gr/m2.

Headrests: 25 kg/m3. Dacron layer 350 gr/m2.

Frame padding: 21 kg/m3

COVERING Leather or microfiber. Not removable. Please check covering details for care instructions.

FEET Shiny metal H 17 cm. Available in chrome, titanium or brushed brass finish

NOTE Headrests and armrests are equipped with manual adjustable mechanism that allows you to find the desired comfort position.

Armrests are equipped with a special friction mechanism that allows you bring them back to the starting position by simply pushing them down. The model can be equipped with the new Sofaudio39x, that allows you to transform your sofa in an extraordinary Hi-Tech piece, ideal for listening to your music or to charge your mobile devices.

STRUCTURE En bois, multiples et particules habillés d'une couche de dacron.

REMBOURRAGE Accoudoirs, cales-reins, dossiers et appuie-tête en polyuréthane expansé à double densité. Toutes les parties susdites sont recouvertes avec une couche de dacron.

Coussins d'assise : Partie supérieure polyuréthane expansé 30 kg/m3 (souple), partie inférieure polyuréthane expansé 35 kg/m3 portante. Tampon en façade 40 kg/m3. Dacron 100 gr/m2.

Accoudoirs: Polyuréthane expansé 30 kg/m3 recouvert en dacron 350 gr/m2.

Cales-reins: Polyuréthane expansé 25 kg/m3 recouvert en dacron 350 gr/m2.

Appuie-tête : 25 kg/m3. Dacron 350/m2.

Rembourrage de complément : densité 21 kg/m3.

RENETEMENT Cuir ou microfibre non déhoussable. Pour les caractéristique du revêtement aussi bien que pour l'entretien veuillez consulter les fiches techniques appropriés.

PIEDS En métal brillant, H 17 cm. Disponible en coloris chrome, titanium ou cuivre brossé

NOTES Les appuie-têtes et les accoudoirs sont équipés d'une mécanique manuelle qui permet de trouver la position désirée.

Les accoudoirs, grâce à la mécanique spéciale à friction, peuvent revenir à la position fermée simplement en appuyant dessus.

Le modèle peut être équipé avec le nouveau Sofaudio39x, vous permettant de transformer votre canapé dans un élément extrêmement Hi-Tech, idéal pour écouter votre musique ou bien pour recharger vos appareils mobiles

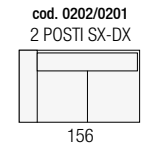
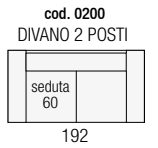
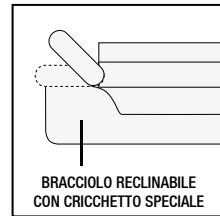
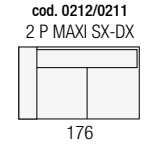
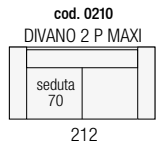
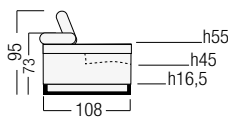
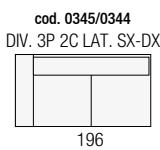
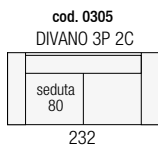

SPECIFICHE

lettore audio e carica iPhone/iPod/iPad - lightning pin bluetooth • NFC • HF reader android • porta USB per lettura audio e carica dispositivi • porta AUX IN per audio • power 4Ω15W per cassa, 6Ω30W subwoofer

COMPOSIZIONE KIT

control box (W 105x105 mm, H 65 mm)
2 casse acustiche • 2 copricasse
subwoofer (L 370x180 mm, H 100 mm)
cavo jack - AUX • trasformatore • manuale d uso

SPECIFICATIONS

lightning dock for play music and recharge iPhone/iPod/iPad bluetooth • NFC • HF reader • USB port • AUX IN port • charger iPhone/iPod • power 4Ω15W for speaker, 6Ω30W subwoofer

KIT COMPOSITION

control box (W 105x105 mm, H 65 mm)
2 speakers • 2 cover speakers
subwoofer (W 370x180 mm, H 100 mm)
Jack cable AUX • transformer • user manual

CARACTÉRISTIQUES

la foudre dock pour jouer de la musique et de recharger l'iPhone / iPod / iPad • Bluetooth • NFC • HF lecteur • port USB • port AUX IN • chargeur pour iPhone / iPod • 4Ω15W de puissance du haut-parleur, 6Ω30W subwoofer

COMPOSITION DU KIT

boîtier de commande (W 105x105 mm, H 65 mm)
2 haut-parleurs • Haut-parleurs 2 de couverture
subwoofer (W 370x180 mm, H 100 mm)
Câble Jack AUX • manuel d'utilisation de transformateur

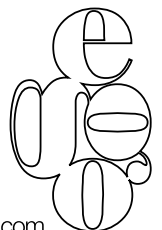
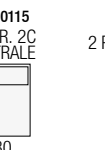
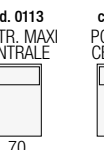
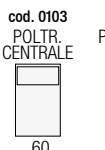
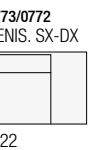
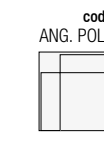
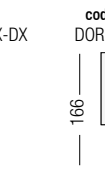
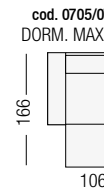
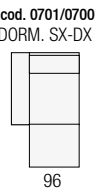
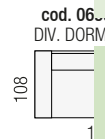
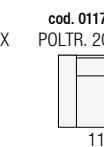
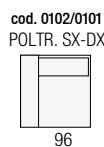
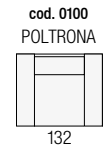

RIVESTIMENTO Pelle o microfibra non sfoderabile. Per le caratteristiche del rivestimento e della manutenzione vedere relative schede tecniche.

IMBOTTITURA Cuscini di seduta, braccioli, poggiaresi e spalliere poggiatesta reclinabili sono realizzate in poliuretano espanso a densità differenziate. Tutte le parti sopraelencate sono ricoperte da una termofalda di dacron autoestinguente. Cuscini di seduta: strato superiore: densità 30 kg/mc (soffice). Strato inferiore: densità 30 kg/mc (portante). Termofalda da 350 gr/mq. Braccioli: tampone superiore doppia densità 40 e 30 kg/mc. Termofalda da 350 gr/mq. Poggiaresi: densità 30 kg/mc. Termofalda da 350 gr/mq. Spalliere poggiatesta: densità 23 kg/mc. Termofalda da 350 gr/mq. Imbottiture di completamento: densità 21 kg/mc.

PIEDI In legno massello di faggio evaporato con profilo in metallo, tinto con vernici ecologiche ad acqua, nei colori wengè, noce brunito

STRUTTURA Realizzata in legno abbinato a particelle di legno grezzo biodegradabile e pannelli di fibra di legno duro.

NOTE Gli schienali sono dotati di meccanismo manuale a cricchetto, reclinabili a seconda del comfort desiderato.

NOTE SU RIVESTIMENTO La variante con cucitura in cordoncino è possibile solo su rivestimento in pelle cat.B e cat.C

COVERING Leather, microfiber or fabric. Not removable.

PADDING Seat cushion, armrest, kidney rest and adjustable headrest: double density polyurethane foam covered with a Dacron layer.

Seat cushion: upper part: 30kg/m3 "soft comfort". Bottom part: 30 kg/m3 "hard comfort". Dacron layer: 350 gr/m2

Armrest: front and back part: 40 kg/m3. Upper part: 30 kg/m3. Dacron layer: 350 gr/m2. Kidney rest: 30 kg/m3. Dacron layer 350 gr/m2. Adjustable headrest: 23 kg/m3. Dacron layer: 350 gr/m2

FEET In n beech wood coloured wengè, walnut or dark walnut. **FRAME** Hard wood combined with plywood and particle board covered with a Dacron layer.

NOTE Model equipped with adjustable headrest.

Thick thread stitching available only with leather cat.B and cat.C

REVETEMENT Cuir ou microfibre non déhoussable.

REMBOURRAGE Coussins d'assise, cale-reins, accoudoirs et appuie-tête réclinables réalisés en polyuréthane écologique à double densité recouvert avec une couche de dacron.

Assise: Partie inférieure: 30 Kg/m3 (rigide). Partie supérieure 30 Kg/m3 (souple). Couche de dacron 350 gr/m2. Accoudoirs: partie supérieure double densité 40 et 30 Kg/m3. Dacron 350 gr/m2. Cale-reins: 30 Kg/m3. Dacron 350 gr/m2.

Appuie-tête: 23 Kg/m3. Dacron 350 gr/m2. Rembourrage de complément: 21 Kg/m3

PIEDS In

STRUCTURE En bois massif, multiplis et particules habillés d'une couche de dacron.

NOTE Les dossiers sont équipés d'un mécanisme manuel au niveau des appuie-tête, réclinables selon le confort désiré.

Couture avec fil épais disponible seulement sur les cuirs cat. B et C

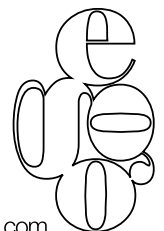
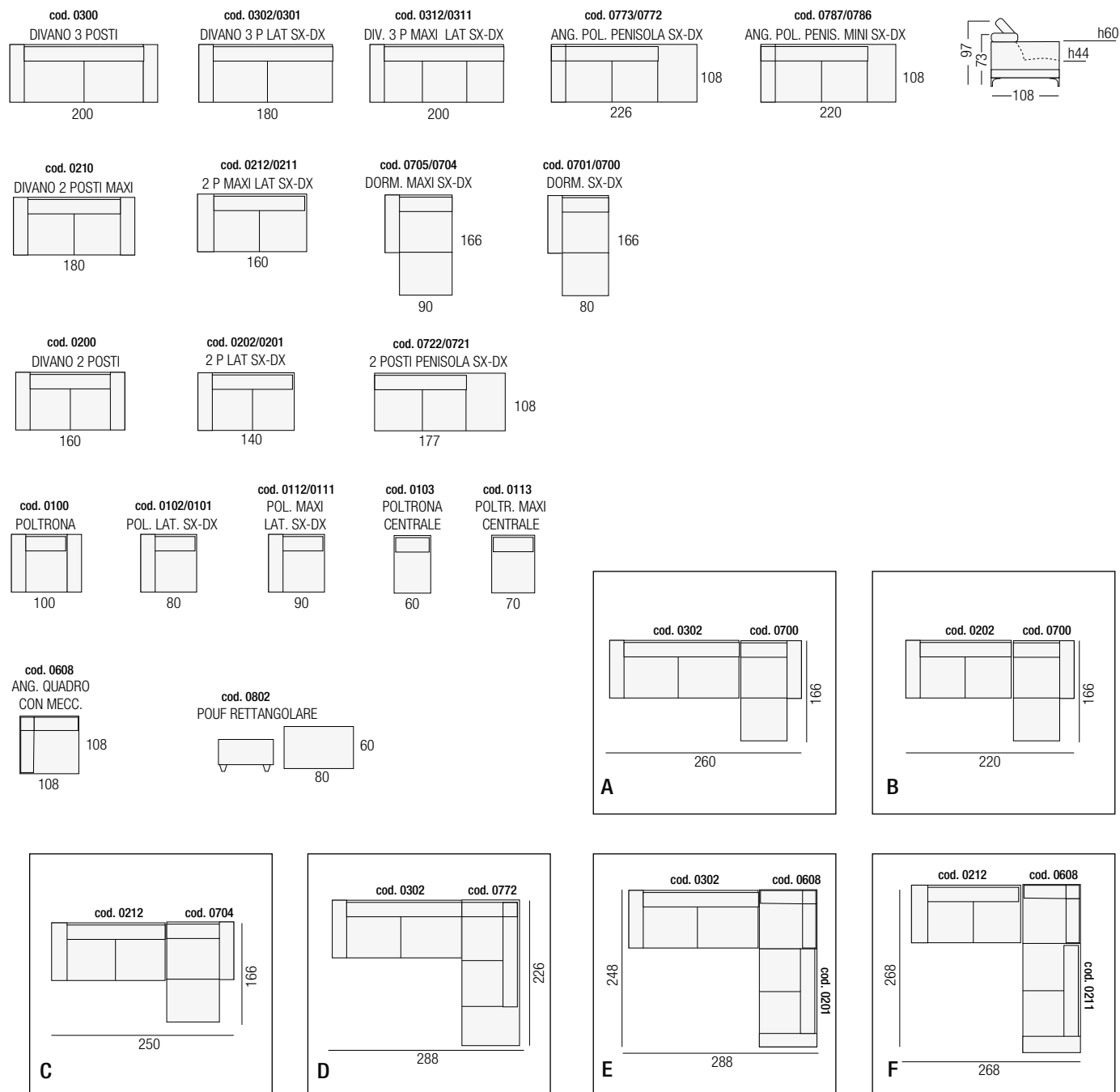

STRUTTURA Realizzata in legno abbinato a particelle di legno grezzo biodegradabile e pannelli di fibra di legno duro.

IMBOTTITURE Cuscini di seduta, braccioli, poggiatesta e spalliere poggiatesta reclinabili sono realizzate in poliuretano espanso a densità differenziate. Tutte le parti sopraelencate sono ricoperte da una termofalda di dacron autoestinguente.

Cuscini di seduta: densità 30 kg/mc. Termofalda da 350 gr/mq.

Braccioli: densità 30 kg/mc. Termofalda da 200 gr/mq.

Spalliere poggiatesta: densità 25 kg/mc. Termofalda da 350 gr/mq.

Imbottiture di completamento: densità 21 kg/mc.

RIVESTIMENTO Pelle o microfibra non sfoderabile. Per le caratteristiche del rivestimento e della manutenzione vedere relative schede tecniche.

PIEDI Il modello è caratterizzato da una struttura portante realizzata in legno massello di rovere, nelle colorazioni rovere naturale o rovere noce canaletto. La struttura è corredata di basette realizzate in metallo, aventi funzione di piedini. Tali basette sono disponibili nella finitura ottone spazzolato e su richiesta nella finitura titanio. H alla base del divano: cm 12.

NOTE Nella versione relax il modello è dotato esclusivamente di doppio meccanismo elettrico con comando posizionato nello spazio interno tra seduta e bracciolo, mentre le sedute centrali sono dotate di tasti con sistema touch control, sempre inseriti tra le sedute. I comandi possono agire indipendentemente tra di loro variando solo l'inclinazione della testiera oppure permettendo di distendere solo le gambe offrendo infinite possibilità di comfort. Gli elementi relax sono sempre staccati da quelli fissi e vengono agganciati con apposito sistema a baionetta. Nelle versioni fisse senza meccanismo relax in ogni caso è presente il cricchetto manuale nelle testiere.

SEAT CUSHIONS In Polyurethane foam 30 kg/m3. Dacron layer 350 gr/m2. Armrests: Polyurethane foam 30 kg/m3. Dacron layer 200 gr/m2.

Backrests: 25 kg/m3. Dacron layer 350 gr/m2. Frame padding: 21 kg/m3

COVERING Leather or microfiber. Not removable. Please check covering details for care instructions.

FEET The model is characterized by a structure made of solid oak, available in the colors; natural oak or walnut canaletto. The structure is accompanied by metal whiskers functioning as feet. These feet are available in brushed brass finish and on demand in titanium finish. H to the base of the sofa: 12 cm.

NOTE The relax version is exclusively available with double electric mechanism having the controls placed on the seat cushion side, between the seat and the armrest. The armless seats are equipped with touch controls placed on the seat side. The mechanisms are independent, allowing you to adjust to the desired comfort position either the headrest or the footrest. The version without mechanism always carries the mechanical headrest. The part with relax is always delivered separately and connected to the fixed part by made for purpose bayonet fittings.

CARCASSE En bois, multiplies et particules habillés d'une couche de dacron.

REMBOURRAGE Accoudoirs, Assises et dossiers en mousse de polyuréthane expansé. Toutes parties susdites sont recouvertes avec une couche de dacron. Coussins d'assise: Partie supérieure en polyuréthane expansé 30 kg/m3. Accoudoirs: Polyuréthane expansé 30 kg/m3. Dacron 200 gr/m2.

Dossiers: Polyuréthane expansé 25 kg/m3. Dacron 350/m2. Rembourrage de complément: densité 21 kg/m3.

REVEITEMENT Cuir ou microfibre non déhoussable. Pour les caractéristique du revêtement aussi bien que pour l'entretien veuillez consulter les fiches techniques appropriés.

PIEDS Le modèle est caractérisé par une structure en chêne massif, dans les couleurs chêne naturel ou noyer canaletto. La structure est finie par des pieds en métal. Les pieds en métal sont disponibles en finition cuivre brossé et sur demande en finition titane. H à la base du canapé: 12 cm.

NOTES En version relax le modèle est disponible exclusivement avec mécanique électrique avec commande située sur le coté interne entre coussin d'assise et accoudoir, alors que les assises sans bras sont équipées de boutons touch sensors situés entre les assises. Les mécaniques peuvent agir de façon indépendante, permettant de bouger uniquement la tête ou l'assise pour obtenir votre confort idéal. Les versions sans relax ont toujours la tête mécanique.

L'élément avec relax est toujours séparé des éléments fixes et relié avec un système à baïonnette

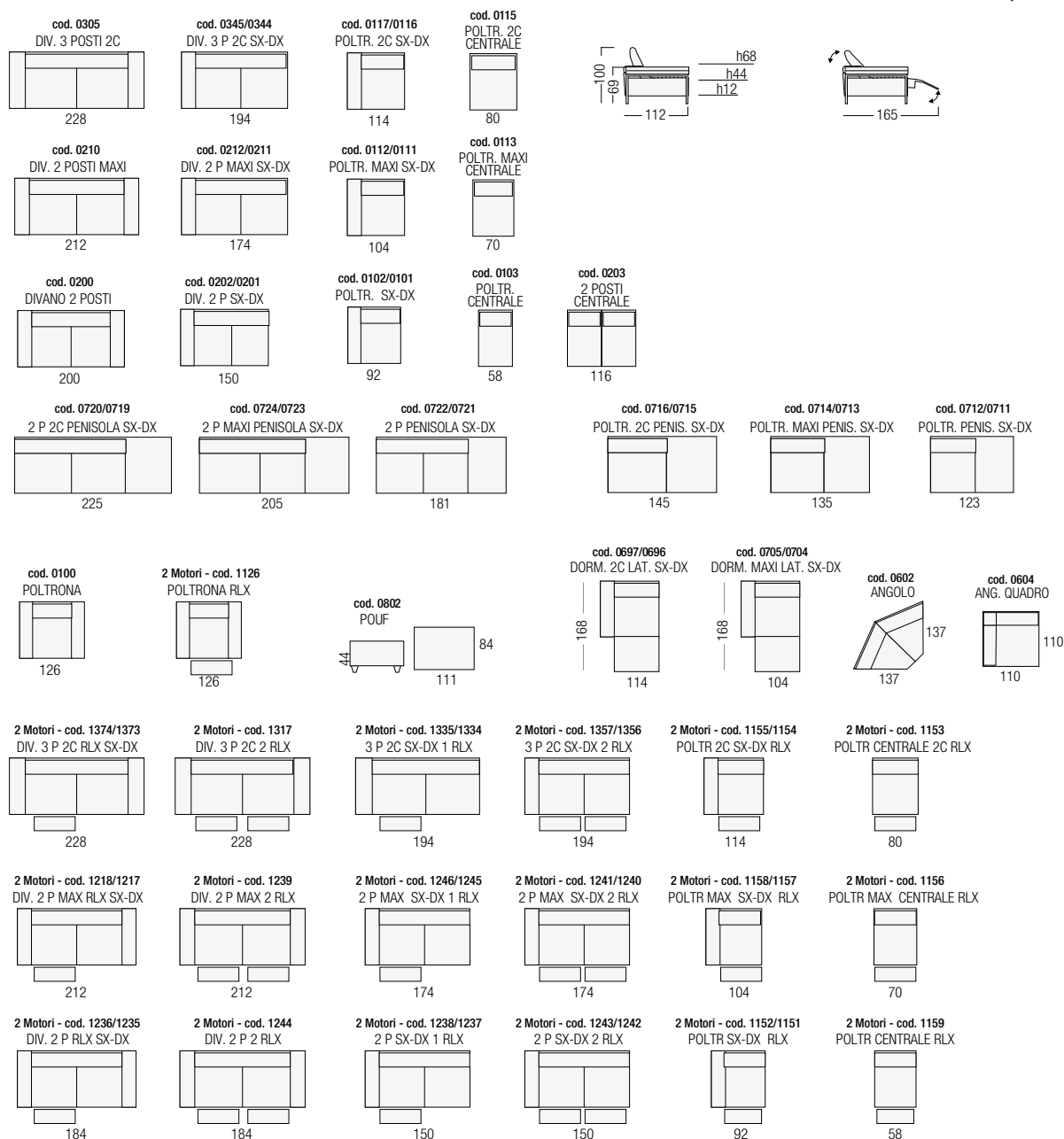

STRUTTURA Realizzata in legno abbinato a particelle di legno grezzo biodegradabile e pannelli di fibra di legno duro.

IMBOTTITURE Cuscini di seduta, braccioli, poggiaieni e spalliere poggiatesta reclinabili sono realizzate in poliuretano espanso a densità differenziate. Tutte le parti sopraelencate sono ricoperte da una termofalda di dacron autoestinguente.

Cuscini di seduta: densità 30 kg/mc. Termofalda da 200 gr/mq.
Braccioli: densità 30 kg/mc. Termofalda da 350 gr/mq.
Poggiaieni: densità 25 kg/mc. Termofalda da 200 gr/mq.
Poggiatesta: densità 25 kg/mc. Termofalda da 350 gr/mq.

Imbottiture di completamento: densità 21 kg/mc.

RIVESTIMENTO Pelle o microfibra non sfoderabile. Per le caratteristiche del rivestimento e della manutenzione vedere relative schede tecniche.

PIEDI in legno massello di faggio evaporato tinto con vernici ecologiche all'acqua. Colore wengè, noce o noce brunito. H = cm. 4

NOTE Nella versione relax il modello è realizzato con meccanismo combinato con movimento schienale poggiatesta. Disponibile sia manuale che elettrico con comando posizionato sul bracciolo laterale. L'elemento relax è sempre staccato da quello fisso e viene agganciato con apposito sistema a baionetta. Il poggiatesta è dotato di uno speciale cricchetto manuale che rende più confortevole la posizione distesa in fase di lettura o di relax davanti alla TV.

Le versioni laterali con 2 meccanismi relax e le poltrone centrali relax sono realizzate esclusivamente con meccanismo dotato di motore elettrico. Le sedute centrali con meccanismo relax elettrico sono dotate di comandi touch control posizionati sul fianco della seduta stessa.

FRAME Hard wood combined with plywood and particle board covered with a Dacron layer.

PADDING Seat cushion, armrest, kidney rest and headrest: double density polyurethane foam covered with a Dacron layer.

Seat cushion: 30kg/m3. Dacron layer: 200 gr/m2
Armrests : 30kg/m3. Dacron layer 350 gr/m2
Kidney rests : 25kg/m3. Dacron layer 200 gr/m2

Headrest: 25 kg/m3. Dacron layer 350 gr/m2

Frame padding: 21 kg/m3

COVERING Leather, microfiber or fabric. Not removable. Please check covering details for care instructions.

FEET In wood available in the colours walnut, dark walnut or Wenge'. Height 4 cm

NOTE Relax versions available both manual and electric. Control panels are placed on the arm side. The relax elements are always separated from the fixed ones and are hooked together with an appropriate bayonet system. The active headrest is provided with a special manual ratchet which allows to adjust to a more comfortable position for reading or relaxing in front of the TV.

The versions with two lateral relaxation mechanisms and the armless relax chairs are equipped exclusively with electric motor. The armless seats are equipped with touch button controls positioned on the seats sides.

STRUCTURE En bois massif, multiplis et particules habillés d'une couche de dacron.

REMBOURRAGE Coussins d'assise, cale-reins, accoudoirs et appui-tête réclinables réalisés en polyuréthane écologique à double densité recouvert avec une couche de dacron.

Coussins d'assise: En mousse 30 Kg/m3. Recouvert d'une couche de Dacron 200gr/m2

Accoudoirs: En mousse 30 Kg/m3. Recouvert d'une couche de Dacron 350gr/m2

Cale-reins: En mousse 25 Kg/m3. Recouvert d'une couche de Dacron 200gr/m2

Appui-tête: En mousse 25 Kg/m3. Recouvert d'une couche de Dacron 350gr/m2

Rembourrage de complément: densité 21 Kg/m3

REVETEMENT Cuir ou microfibre non déhoussable. Pour les caractéristique du revêtement aussi bien que pour l'entretien veuillez consulter les fiches techniques appropriés.

PIEDS En bois massif teinté noyer, noyer foncé et wengé, h 4 cm.

NOTE Les versions relax sont disponible avec mécanique manuelle ou électrique avec commandes placés sur le côté du bras. Les éléments avec relax sont toujours séparés de ceux fixes et sont accrochés avec le système à baionnette appropriée. L'appui-tête actif est fourni avec un cliquet manuel spécial qui permet un position plus confortable en cas de lecture ou de détente devant la télévision.

Les versions avec deux mécanismes de relaxation latérales et les batards avec relax sont équipés uniquement avec moteur électrique. Les contrôle touch sensor (touche tactile) insérés sur le côté des assises.

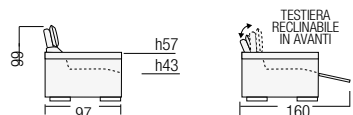
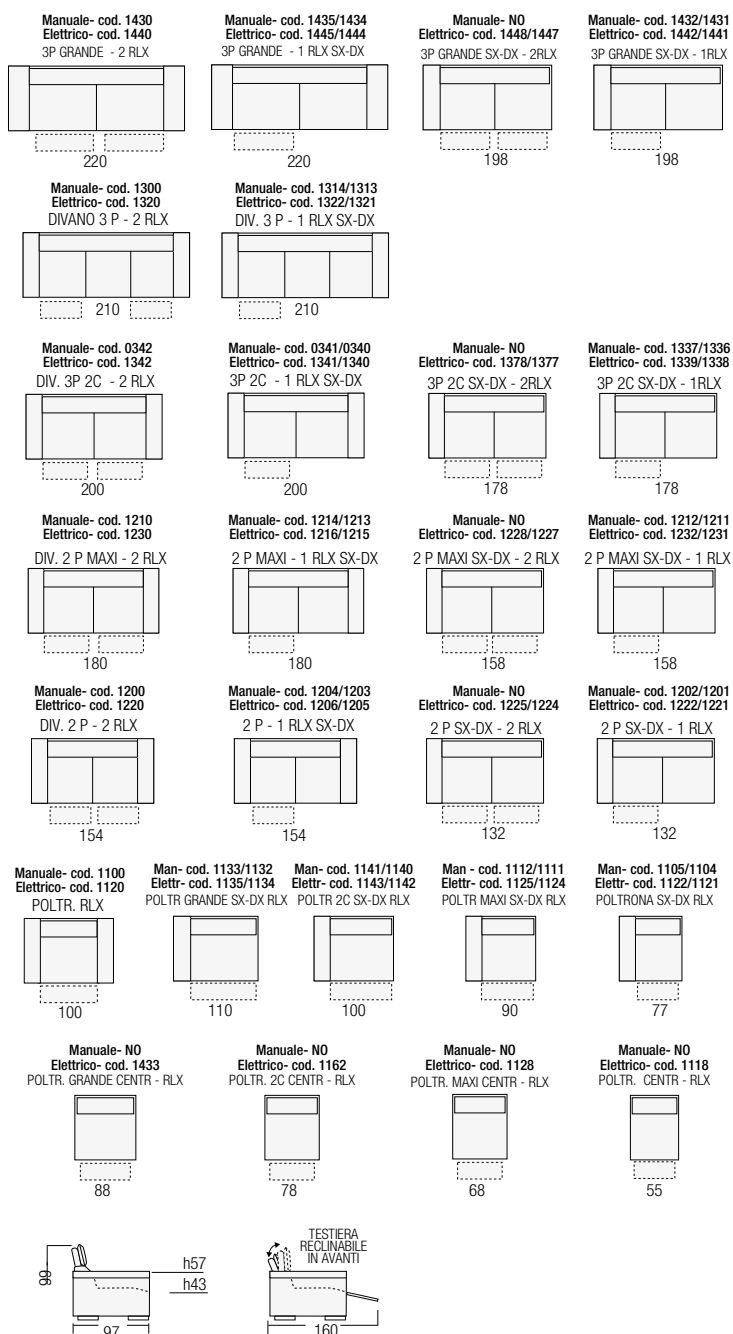
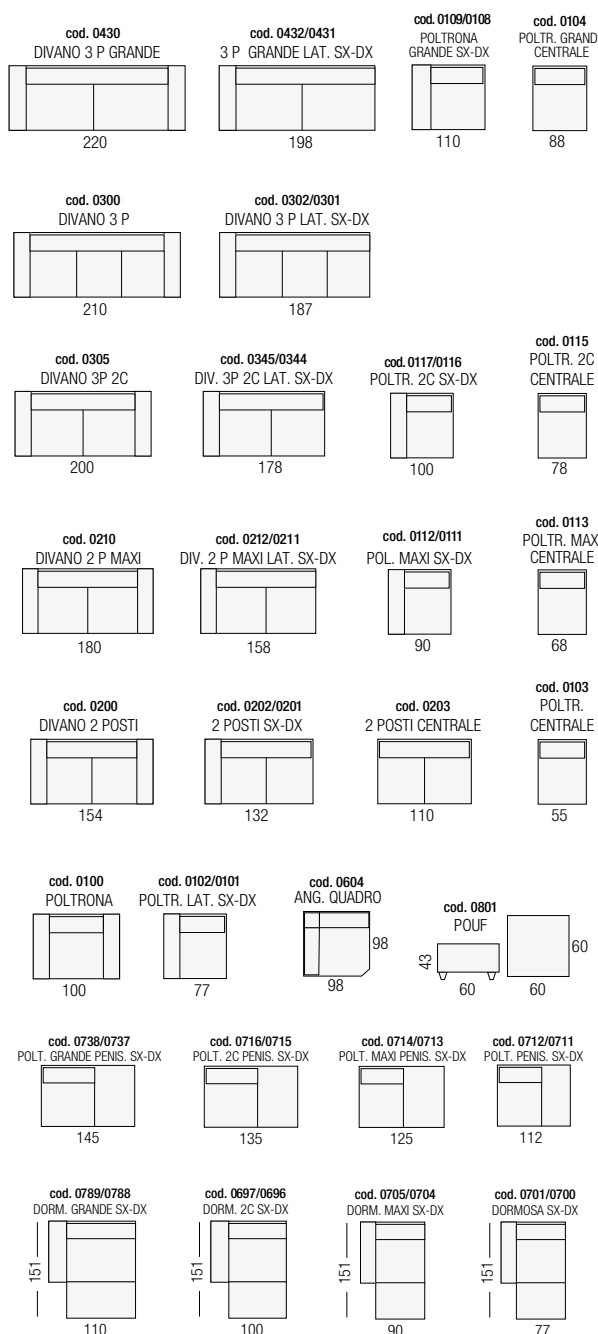

STRUTTURA Realizzata in legno abbinato a particelle di legno grezzo biodegradabile e pannelli di fibra di legno duro.

IMBOTTITURE Cuscini di seduta, braccioli, poggiaresi e spalliere poggiatesta reclinabili sono realizzate in poliuretano espanso a densità differenziate. Tutte le parti sopraelencate sono ricoperte da una termofalda di dacron autoestinguente. Cuscini di seduta: densità 30 kg/mc. Termofalda da 200 gr/mq. Braccioli: densità 30 kg/mc. Termofalda da 350 gr/mq. Poggiaresi: densità 25 kg/mc. Termofalda da 200 gr/mq. Poggiatesta: densità 25 kg/mc. Termofalda da 350 gr/mq. Imbottiture di completamento: densità 21 kg/mc.

RIVESTIMENTO Pelle o microfibra non sfoderabile. Per le caratteristiche del rivestimento e della manutenzione vedere relative schede tecniche.

PIEDI in legno massello di faggio evaporato tinto con vernici ecologiche all'acqua. Colore wengè, noce o noce brunito. H = cm. 4

NOTE Nella versione relax il modello è realizzato con meccanismo combinato con movimento schienale poggiatesta. Disponibile sia manuale che elettrico con comando posizionato sul bracciolo laterale. L'elemento relax è sempre staccato da quello fisso e viene agganciato con apposito sistema a baionetta. Il poggiatesta è dotato di uno speciale cricchetto manuale che rende più confortevole la posizione distesa in fase di lettura o di relax davanti alla TV.

Le versioni laterali con 2 meccanismi relax e le poltrone centrali relax sono realizzate esclusivamente con meccanismo dotato di motore elettrico. Le sedute centrali con meccanismo relax elettrico sono dotate di comandi touch control posizionati sul fianco della seduta stessa.

FRAME Hard wood combined with plywood and particle board covered with a Dacron layer.

PADDING Seat cushion, armrest, kidney rest and headrest: double density polyurethane foam covered with a Dacron layer.
 Seat cushion: 30kg/m3. Dacron layer: 200 gr/m2
 Armrests : 30kg/m3. Dacron layer 350 gr/m2
 Kidney rests : 25kg/m3. Dacron layer 200 gr/m2
 Headrest: 25 kg/m3. Dacron layer 350 gr/m2
 Frame padding: 21 kg/m3

COVERING Leather, microfiber or fabric. Not removable. Please check covering details for care instructions.

FEET In wood available in the colours walnut, dark walnut or Wenge'. Height 4 cm
NOTE Relax versions available both manual and electric. Control panels are placed on the arm side. The relax elements are always separated from the fixed ones and are hooked together with an appropriate bayonet system. The active headrest is provided with a special manual ratchet which allows to adjust to a more comfortable position for reading or relaxing in front of the TV.

The versions with two lateral relaxation mechanisms and the armless relax chairs are equipped exclusively with electric motor. The armless seats are equipped with touch button controls positioned on the seats sides.

STRUCTURE En bois massif, multiplis et particules habillés d'une couche de dacron.

REMBOURRAGE Coussins d'assise, cale-reins, accoudoirs et appui-tête réclinables réalisés en polyuréthane écologique à double densité recouvert avec une couche de dacron.

Coussins d'assise: En mousse 30 Kg/m3. Recouvert d'une couche de Dacron 200gr/m2

Accoudoirs: En mousse 30 Kg/m3. Recouvert d'une couche de Dacron 350gr/m2

Cale-reins: En mousse 25 Kg/m3. Recouvert d'une couche de Dacron 200gr/m2

Appui-tête: En mousse 25 Kg/m3. Recouvert d'une couche de Dacron 350gr/m2

Rebourrage de complément: densité 21 Kg/m3

REVETEMENT Cuir ou microfibre non déhoussable. Pour les caractéristique du revêtement aussi bien que pour l'entretien veuillez consulter les fiches techniques appropriés.

PIEDS En bois massif teinté noyer, noyer foncé et wengé, h 4 cm.

NOTE Les versions relax sont disponible avec mécanique manuelle ou électrique avec commandes placés sur le côté du bras. Les éléments avec relax sont toujours séparés de ceux fixes et sont accrochés avec le système à baionnette appropriée. L'appui-tête actif est fourni avec un cliquet manuel spécial qui permet un position plus confortable en cas de lecture ou de détente devant la télévision. Les versions avec deux mécanismes de relaxation latérales et les batards avec relax sont équipés uniquement avec moteur électrique. Les contrôle touch sensor (touche tactile) insérés sur le côté des assises.

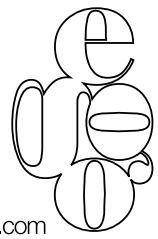
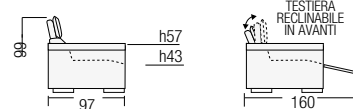
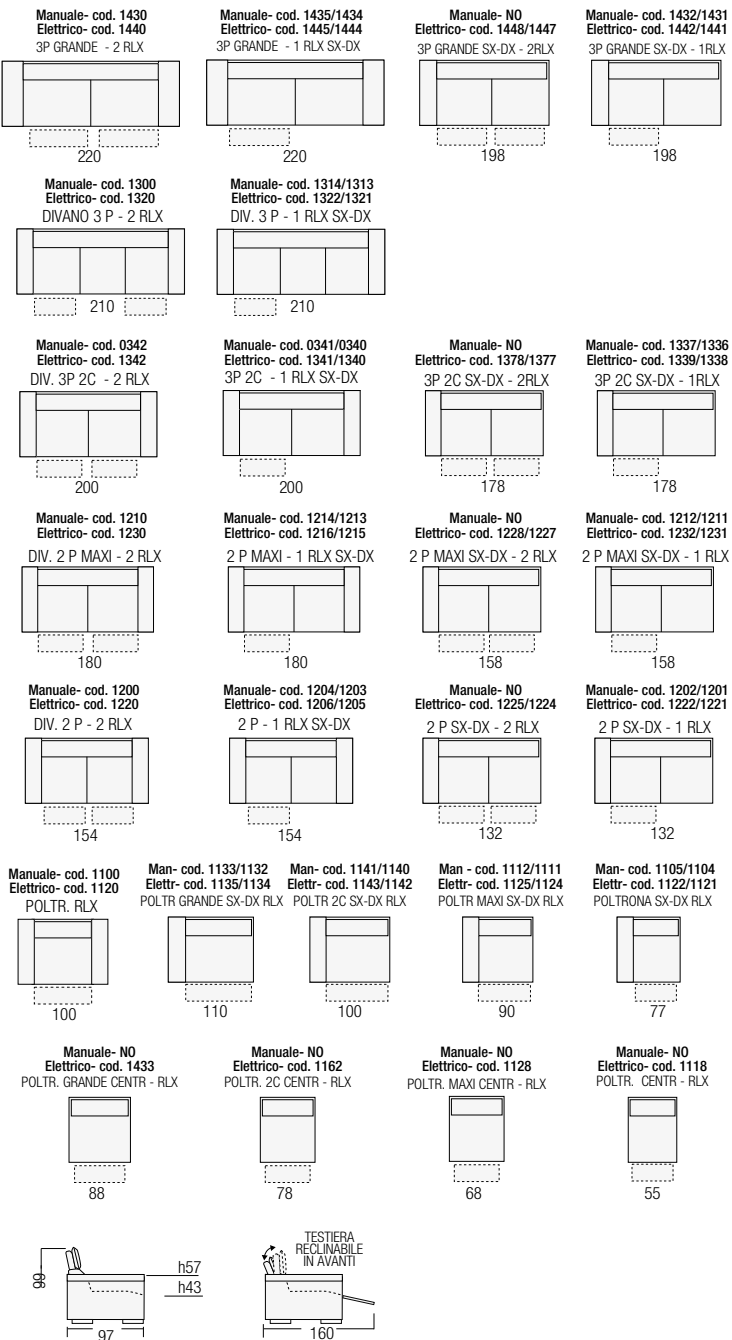
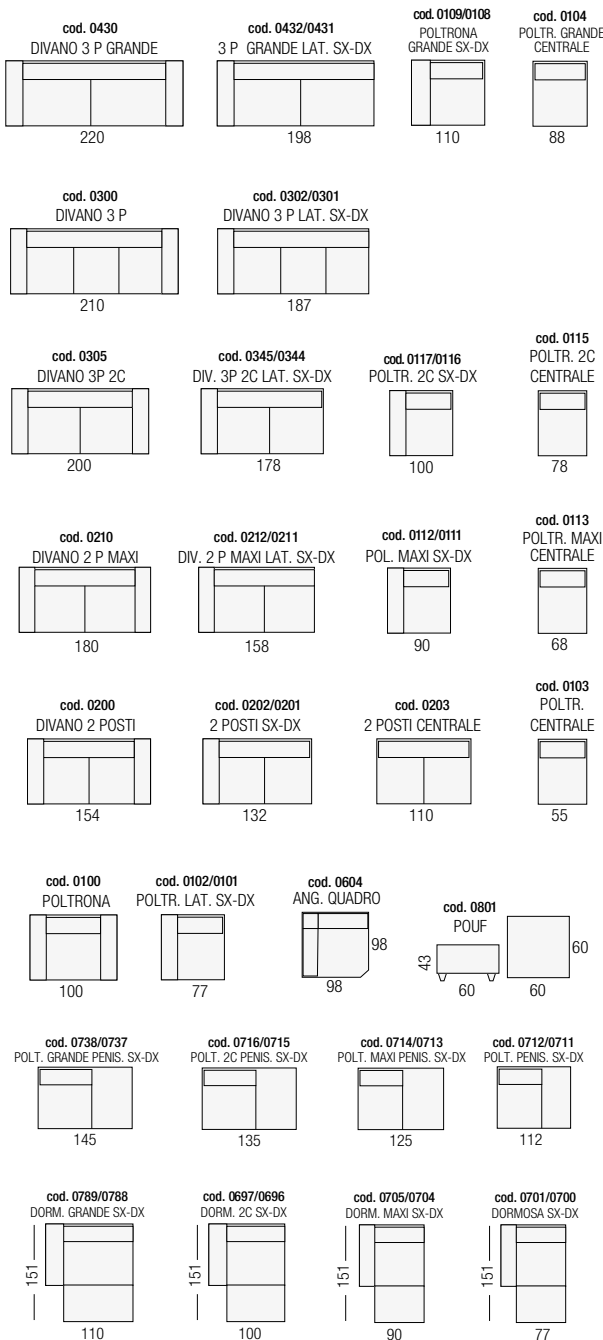

STRUTTURA Realizzata in legno abbinato a particelle di legno grezzo biodegradabile e pannelli di fibra di legno duro.

IMBOTTITURE Cuscini di seduta, braccioli, poggiatesta e spalliere poggiatesta reclinabili sono realizzate in poliuretano espanso a densità differenziate. Tutte le parti sopraelencate sono ricoperte da una termofalda di dacron autoestinguente. Cuscini di seduta: strato superiore: densità 30 kg/mc. Strato inferiore: densità 35 kg/mc, rivestiti con falda di dacron in fibra di poliestere da 100 gr/mq. Braccioli: strato superiore: densità 30 kg/mc. Strato anteriore e posteriore: densità 40 kg/mc. Termofalda di dacron in fibra di poliestere da 400 gr/mq. Poggiatesta: densità 30 kg/mc. Termofalda di dacron in fibra di poliestere da 450 gr/mq. Spalliere poggiatesta: densità 23 kg/mc. Termofalda di dacron in fibra di poliestere da 450 gr/mq. Imbottiture di completamento: densità 21 kg/mc.

RIVESTIMENTO Pelle o microfibra non sfoderabile. Per le caratteristiche del rivestimento e della manutenzione vedere relative schede tecniche.

PIEDI In legno massello tinto wengè con profilo cromato. H = cm 4

NOTE Nella versione relax il modello è dotato esclusivamente di meccanismo elettrico con comando posizionato sul lato interno del divano, mentre le sedute centrali sono dotate di tasti touch control inseriti sul fianco interno delle sedute stesse. I comandi possono agire indipendentemente tra di loro variando solo l'inclinazione della testiera oppure permettendo di distendere solo le gambe offrendo infinite possibilità di comfort. Gli elementi relax sono sempre staccati da quelli fissi e vengono agganciati con apposito sistema a baionetta. Nelle versioni fisse senza meccanismo relax in ogni caso è presente il cricchetto manuale nelle testiere.

FRAME Hard wood combined with plywood and particle board covered with a Dacron layer.

PADDING Seat cushion, armrest, kidney rest and headrest: double density polyurethane foam covered with a Dacron layer.
Seat cushion: upper part: 30kg/m³ "soft comfort". Bottom part: 35 kg/m³ "normal comfort". Dacron layer: 100 gr/m²

Armrests : upper part: 30kg/m³. Lower and front part: 40 kg/m³. Dacron layer 400 gr/m²

Kidney rests : 30kg/m³. Dacron layer 400 gr/m²

Headrest: 23 kg/m³. Dacron layer 450 gr/m²

Frame padding: 21 kg/m³

COVERING Leather, microfiber or fabric. Not removable. Please check covering details for care instructions.

FEET Wenge' wood with chromium-plated profile. Height 4 cm

NOTE In the relax version the model is equipped exclusively with electrical mechanism having its controls positioned on the inner side of the armrest, while the armless seats are equipped with touch button controls positioned on the seats sides. The controls can act independently of each other by varying only the tilt of the headrests or allowing to stretch only the footrests thus allowing many different comfort positions. The relax elements are always separated from the fixed ones and are hooked together with an appropriate bayonet system. Fixed versions without relax mechanism are always equipped with adjustable manual headrests.

STRUCTURE En bois massif, multiplis et particules habillés d'une couche de dacron.

REMBOURRAGE Coussins d'assise, cale-reins, accoudoirs et appuie-tête réclinables réalisés en polyuréthane écologique à double densité recouvert avec une couche de dacron.

Coussins d'assise: Partie supérieure 30 Kg/m³. Partie inférieure: 35 Kg/m³.

Recouvert d'une couche de Dacron 100gr/m²

Accoudoirs: Partie supérieure 30 Kg/m³. Partie inférieure et frontale 40 Kg/m³.

Dacron 400 gr/m²

Cale-reins: densité 30 Kg/m³. Dacron 450 gr/m²

Appuie-tête: densité 23 Kg/m³. Dacron 450 gr/m²

Rembourrage de complément: densité 21 Kg/m³

REVETEMENT Cuir ou microfibre non déhoussable. Pour les caractéristique du revêtement aussi bien que pour l'entretien veuillez consulter les fiches techniques appropriés.

PIEDS En bois massif teinté wengé avec profil chromé, h 4 cm

NOTE Dans les versions avec relax le modèle est équipé exclusivement d'un mécanisme électrique ayant son clavier placé sur le côté interne de l'accoudoir, tandis que les batards sont équipés de contrôle touch sensor (touche tactile) insérés sur le côté des assises. Les commandes peuvent agir indépendamment les uns des autres en faisant varier seulement l'inclinaison de la tête ou des repose pieds, permettant de nombreuses positions de confort. Les éléments avec relax sont toujours séparés de ceux fixes et sont accrochés.

VERSIONI CON MECCANISMO RELAX AZIONABILE SOLO ELETTRICAMENTE.

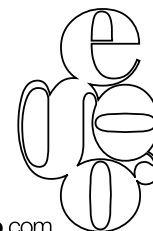
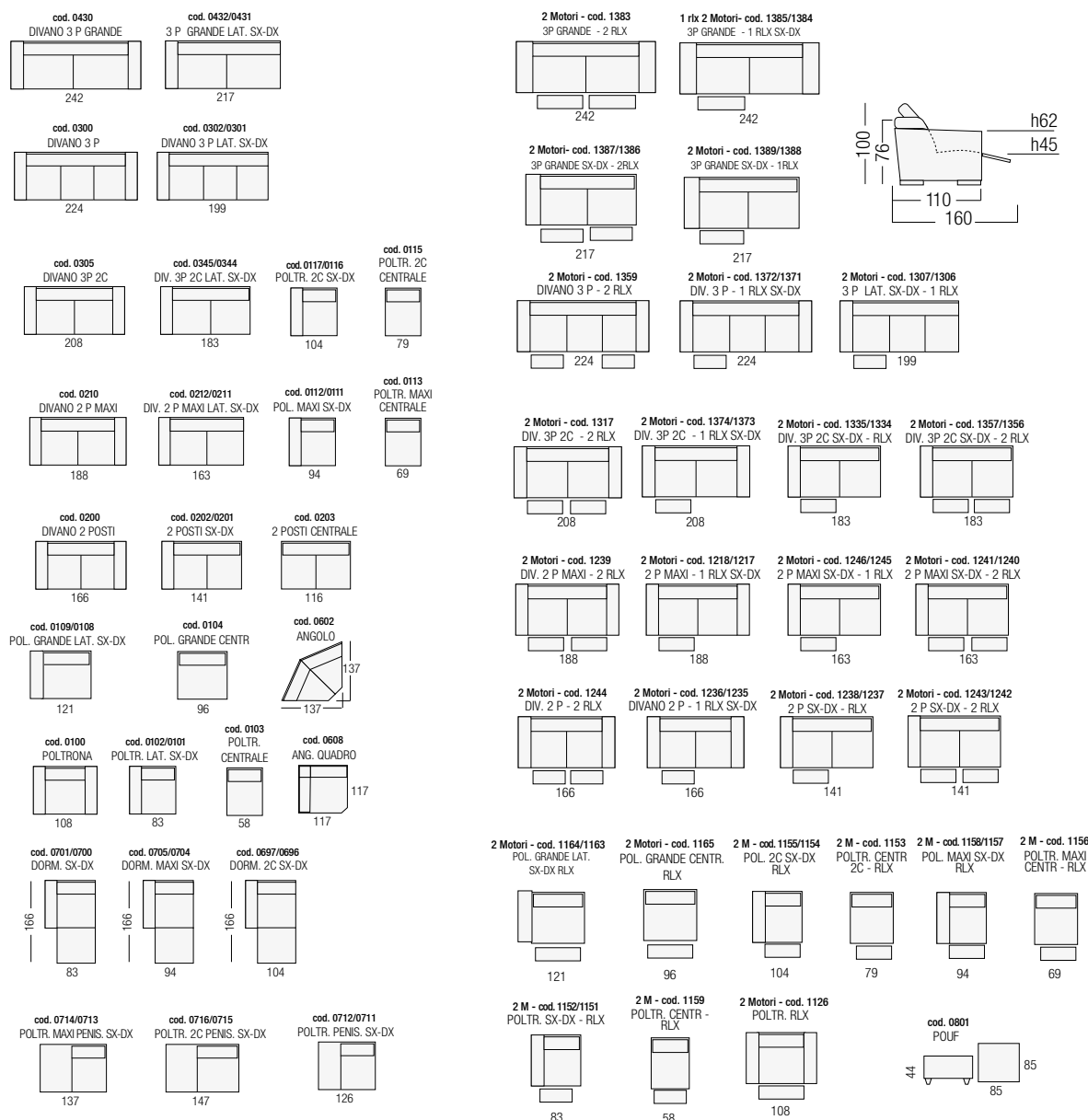

STRUTTURA Realizzata in legno abbinato a particelle di legno grezzo biodegradabile e pannelli di fibra di legno duro.

IMBOTTITURE Braccioli, poggiatesta e spalliere poggiatesta reclinabili sono realizzate in poliuretano espanso a densità differenziate. Tutte le parti sopraelencate sono ricoperte da una termofalda di dacron autoestinguente. Cuscini di seduta: strato superiore: densità 30 kg/mc. soffice. Strato inferiore: densità 35 kg/mc. portante. Tampono anteriore: densità 40 kg/mc. Falda in dacron resinato da 100 gr/mq.

Braccioli: densità 30 kg/mc. Termofalda da 350 gr/mq.

Poggiatesta: densità 25 kg/mc. Termofalda da 350 gr/mq.

Spalliere poggiatesta: densità 25 kg/mc. Termofalda da 350 gr/mq.

Imbottiture di completamento: densità 21 kg/mc.

RVESTIMENTO Pelle o microfibra non sfoderabile. Per le caratteristiche del rivestimento e della manutenzione vedere relative schede tecniche.

PIEDI Struttura in acciaio, H alla base del divano: cm 14. Disponibili nelle finiture: cromato, ottone spazzolato, titanio.

NOTE Gli schienali ed i braccioli sono dotati di meccanismo manuale a cricchetto, reclinabili a seconda del comfort desiderato.

I braccioli, grazie agli speciali cricchetti a frizione di cui sono dotati, possono essere riportati in posizione di chiusura semplicemente premendo verso il basso.

Il modello può essere corredato con il nuovo Sofaudio39x, che permette di trasformare il vostro divano in uno straordinario elemento Hi-Tech, ideale per ascoltare musica o ricaricare i vostri dispositivi mobili.

FRAME Hardwood combined with plywood and particle board.

PADDING Armrests, lumbar supports, backrests and headrests are made in polyurethane foam with varying density. All of the above parts are covers with a Dacron layer.

Seat cushions: upper part: 30 kg/m³ "soft comfort". Bottom part: 35 kg/m³ "hard comfort". Front pad: 40 kg/m³. Dacron layer 100 gr/m².

Armrests: Polyurethane foam 30 kg/m³ covered in dacron 350 gr/m².

Lumbar supports: Polyurethane foam 25 kg/m³ covered in dacron 350 gr/m².

Headrests: 25 kg/m³. Dacron layer 350 gr/m².

Frame padding: 21 kg/m³

COVERING Leather or microfiber. Not removable. Please check covering details for care instructions.

FEET Polished stainless steel. Height 14cm. Available in chrome, titanium or brushed brass finish

NOTE Headrests and armrests are equipped with manual adjustable mechanism that allows you to find the desired comfort position.

Armrests are equipped with a special friction mechanism that allows you bring them back to the starting position by simply pushing them down.

The model can be equipped with the new Sofaudio39x, that allows you to transform your sofa in an extraordinary Hi-Tech piece, ideal for listening to your music or to charge your mobile devices.

STRUCTURE En bois, multiples et particules habillés d'une couche de dacron.

REMBOURRAGE Accoudoirs, cales-reins, dossiers et appuie-tête en polyuréthane expansé à double densité. Toutes les parties susdites sont recouvertes avec une couche de dacron.

Coussins d'assise : Partie supérieure polyuréthane expansé 30 kg/m³ (souple), partie inférieure polyuréthane expansé 35 kg/m³ portante. Tampon en façade 40 kg/m³. Dacron 100 gr/m².

Accoudoirs: Polyuréthane expansé 30 kg/m³ recouvert en dacron 350 gr/m².

Cales-reins: Polyuréthane expansé 25 kg/m³ recouvert en dacron 350 gr/m².

Appuie-tête : 25 kg/m³. Dacron 350/m².

Rembourrage de complément : densité 21 kg/m³.

REVETEMENT Cuir ou microfibre non déhoussable. Pour les caractéristique du revêtement aussi bien que pour l'entretien veuillez consulter les fiches techniques appropriés.

PIEDS Structure en acier, base du canapé H: 14 cm. Disponible en coloris chrome, titanium ou cuivre brossé

NOTES Les appuie-têtes et les accoudoirs sont équipés d'une mécanique manuelle qui permet de trouver la position désirée.

Les accoudoirs, grâce à la mécanique spéciale à friction, peuvent revenir à la position fermée simplement en appuyant dessus.

Le modèle peut être équipé avec le nouveau Sofaudio39x, vous permettant de transformer votre canapé dans un élément extrêmement Hi-Tech, idéal pour écouter votre musique ou bien pour recharger vos appareils mobiles

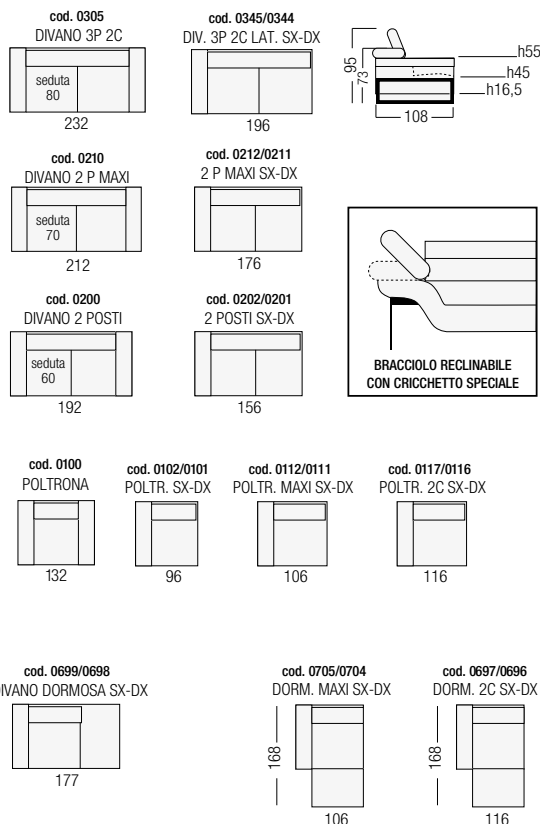

SPECIFICHE

lettore audio e carica iPhone/iPod/iPad - lightning pin bluetooth • NFC • HF reader android • porta USB per lettura audio e carica dispositivi • porta AUX IN per audio • power 4Ω15W per cassa, 6Ω30W subwoofer

COMPOSIZIONE KIT

control box (W 105x105 mm, H 65 mm)
2 casse acustiche • 2 copricassa
subwoofer (L 370x180 mm, H 100 mm)
cavo jack - AUX • trasformatore • manuale d uso

SPECIFICATIONS

lightning dock for play music and recharge iPhone/iPod/iPad bluetooth • NFC • HF reader • USB port • AUX IN port • charger iPhone/iPod • power 4Ω15W for speaker, 6Ω30W subwoofer

KIT COMPOSITION

control box (W 105x105 mm, H 65 mm)
2 speakers • 2 cover speakers
subwoofer (W 370x180 mm, H 100 mm)
Jack cable AUX • transformer • user manual

CARACTÉRISTIQUES

la foudre dock pour jouer de la musique et de recharger l'iPhone / iPod / iPad • Bluetooth • NFC • HF lecteur • port USB • port AUX IN • chargeur pour iPhone / iPod • 4Ω15W de puissance du haut-parleur, 6Ω30W subwoofer

COMPOSITION DU KIT

boîtier de commande (W 105x105 mm, H 65 mm)
2 haut-parleurs • Haut-parleurs 2 de couverture
subwoofer (W 370x180 mm, H 100 mm)
Câble Jack AUX • manuel d'utilisation de transformateur

ANGOLI CON KIT SOFAUDIO X39

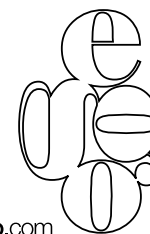
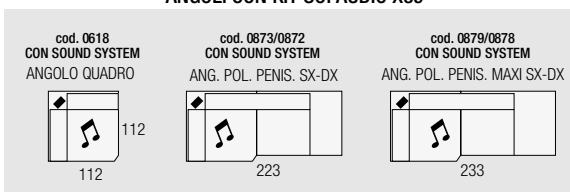
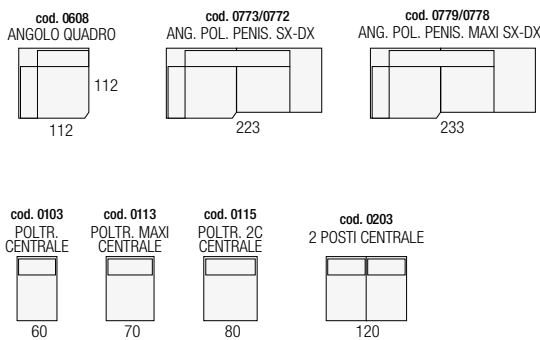

STRUTTURA Realizzata in legno abbinato a particelle di legno grezzo biodegradabile e pannelli di fibra di legno duro.

IMBOTTITURE Cuscini di seduta, braccioli, poggiatesta e spalliere poggiatesta reclinabili sono realizzate in poliuretano espanso. Tutte le parti sopraelencate sono ricoperte da una termofalda di dacron autoestingente. Cuscini di seduta a densità differenziata: parte superiore di densità 30 kg/mc soffice, parte inferiore di densità 35 kg/mc portante, ricoperti da una termofalda da 350 gr/mq.

Braccioli: densità 35 kg/mc. Termofalda da 350 gr/mq.

Poggiatesta: densità 25 kg/mc. Termofalda da 450 gr/mq.

Spalliere poggiatesta: densità 25 kg/mc. Termofalda da 450 gr/mq.

Imbottiture di completamento: densità 21 kg/mc.

RIVESTIMENTO Pelle o microfibra, non sfoderabile. Per le caratteristiche del rivestimento e della manutenzione vedere relative schede tecniche.

PIEDI In legno massello di faggio evaporato con profilo in metallo, tinto con vernici ecologiche ad acqua, nei colori wengè, noce brunito, noce. H: cm. 5.

NOTE Gli schienali sono dotati di meccanismo manuale a cricchetto, reclinabili a seconda del comfort desiderato.

le versioni letto sono dotate di reti a due pieghe elettrosaldate, realizzate in acciaio ad alta resistenza, verniciate a forno con polveri epossidiche.

Reti: divano 3 posti: 180x201; divano 2 posti maxi:

160x201; 2 posti: 140x201; poltrona: 90x201.

Materassi: in poliuretano espanso divano 3 posti: 160x196x16; divano 2 posti

maxi: 140x196x16; divano 2 posti: 120x196x16; poltrona: 70x196x16.

FRAME Hardwood combined with plywood and particle board.

PADDING Seat cushion, armrests, lumbar supports and backrests-headrests are made in polyurethane foam. Every part mentioned is covered with a layer of self extinguishing dacron.

Seat cushions with varying density: Upper part 35 kg/m3 soft, bottom part 35 kg/m3 supporting. Dacron layer 350 gr/m2.

Armrests: Polyurethane foam 30 kg/m3 with part in density 40 kg/m3. Dacron layer 400 gr/m2.

Lumbar supports: Polyurethane foam 25 kg/m3. Dacron layer 450 gr/m2.

Backrests-headrests: Polyurethane foam 25 kg/m3. Dacron layer 450 gr/m2.

Frame padding: Polyurethane foam 21 kg/m3.

COVER Leather not removable. Fabric or microfiber fully removable. Please check covering details for care instructions.

FEET In polished steel or in beech wood coloured wengè, walnut or dark walnut. H 5 cm.

NOTE Bed versions are equipped with two folds electro-welded bed mechanisms made of steel painted with epoxy powder finishes baked.

Mechanisms: 3 seater 180x201; 2 seater maxi 160x201; 2 seater 140x201; Armchair 90x201.

Matress : in polyurethane foam 3 seater 160x193x16; 2 seater maxi 140x193x16 ; 2 seater 120x193x16 ; Armchair 70x193x16.

STRUCTURE En bois, multiples et particules habillés d'une couche de dacron.

REMBOURRAGE Coussins d'assise, accoudoirs, cale reins et dossiers appui-tête en polyuréthane expansé.

Toutes les parties indiquées sont couvertes par une couche de dacron autoextinguible.

Coussins d'assise à densité différenciée: Partie supérieure 35 kg/m3 souple, partie inférieure 35 kg/m3 portante. Couche en dacron 350 gr/m2.

Accoudoirs: Polyuréthane expansé 30 kg/m3 avec parties en densité 40 kg/mc recouvert avec une couche de dacron 400 gr/m2.

Cale reins: Polyuréthane expansé 25 kg/m3 recouvert avec une couche de dacron 450 gr/m2.

Dossiers appui-tête: Polyuréthane expansé 25 kg/m3 recouvert avec une couche de dacron 450 gr/m2.

Rembourrage de complément : densité 21 kg/m3.

REVETEMENT Cuir non déhoussable. Microfibre ou tissu déhoussable. Pour les caractéristiques du revêtement aussi bien que pour l'entretien veuillez consulter les fiches techniques appropriées.

PIEDS En acier poli ou en hêtre massif teinté wengés, noyer ou noyer foncé. H 5 cm.

NOTE Les versions lit sont équipées avec sommier deux plis électro-soudé, réalisé en acier à haute résistance, peint avec des poudres époxy au four.

Sommiers : 3 places 180 x 201 ; 2places maxi 160 x 201 ; 2 places 140 x 201; Fauteuil 90 x 201.

Matelas : en polyuréthane 3 places 160x193x16; 2 places maxi 140x193x16 ; 2 places 120x193x16 ; Fauteuil 70x193x16.

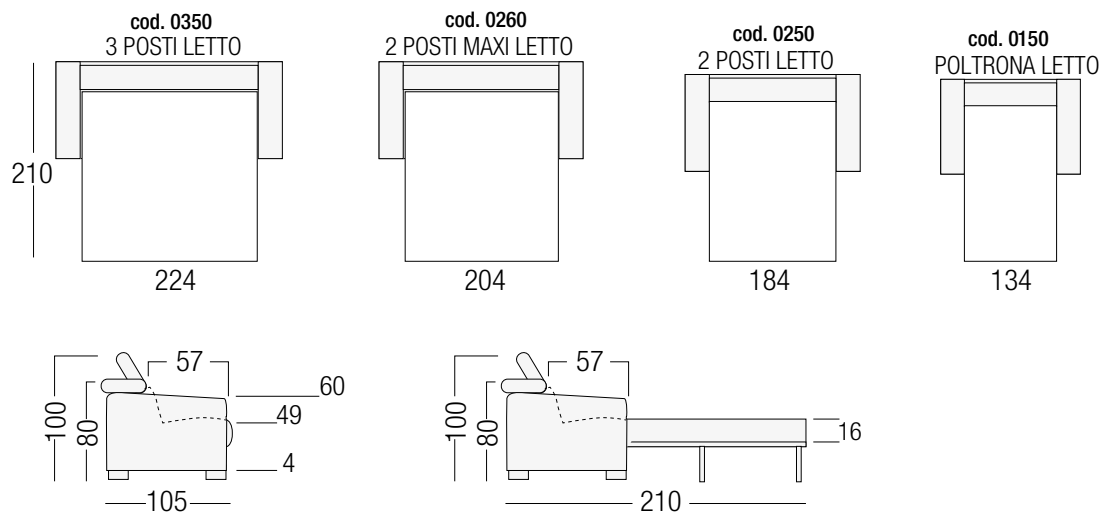

STRUTTURA Realizzata in legno abbinato a particelle di legno grezzo biodegradabile e pannelli di fibra di legno duro.

IMBOTTITURE Cuscini di seduta, braccioli, poggiatesta e spalliere poggiatesta reclinabili sono realizzate in poliuretano espanso. Tutte le parti sopraelencate sono ricoperte da una termofalda di dacron autoestinguente.

Cuscini di seduta a densità differenziata: parte superiore di densità 30 kg/mc soffice, parte inferiore di densità 30 kg/mc portante, ricoperti da una termofalda da 350 gr/mq.

Braccioli: densità 30 kg/mc. Termofalda da 350 gr/mq.

Poggiatesta: densità 25 kg/mc. Termofalda da 350 gr/mq.

Spalliere poggiatesta: densità 25 kg/mc. Termofalda da 350 gr/mq.

Imbottiture di completamento: densità 21 kg/mc.

RIVESTIMENTO Pelle o microfibra non sfoderabile. Per le caratteristiche del rivestimento e della manutenzione vedere relative schede tecniche.

PIEDI In legno massello di faggio evaporato tinto con vernici ecologiche ad acqua, nei colori noce, noce brunito o wengé.

NOTE Nella versione relax il modello è dotato esclusivamente di meccanismo elettrico con comando posizionato sul lato esterno del divano, mentre le sedute centrali sono dotate di un pratico telecomando. Gli elementi relax sono sempre staccati da quelli fissi e vengono agganciati con apposito sistema a baionetta. Nelle versioni fisse senza meccanismo relax in ogni caso è presente il cricchetto manuale nelle testiere.

FRAME Hardwood combined with plywood and particle board.

PADDING Seat cushion, armrests, lumbar supports and backrests-headrests are made in polyurethane foam. Every part mentioned is covered by a Dacron layer.

Seat cushions with varying density: Upper part 30 kg/m3 soft, bottom part 30 kg/m3 supporting. Dacron layer 350 gr/m2.

Armrests: Polyurethane foam 30 kg/m3. Dacron layer 350 gr/m2.

Lumbar supports: Polyurethane foam 25 kg/m3. Dacron layer 350 gr/m2.

Backrests-headrests: Polyurethane foam 25 kg/m3. Dacron layer 350 gr/m2.

Frame padding: Polyurethane foam 21 kg/m3.

COVERING Leather or microfiber. Not removable. Please check covering details for care instructions.

FEET In beech wood coloured with water based paint in wengé, walnut or dark walnut.

NOTE The relax version comes with electric movements only. Controls are placed on the armrest side, whilst armless units are equipped with a remote control. Elements with relax mechanism always delivered separately and connected to the fixed parts by made for purpose bayonet fittings. Fixed versions are always equipped with mechanical headrests mechanism.

STRUCTURE En bois, multiples et particules habillés d'une couche de dacron.

REMBOURRAGE Coussins d'assise, accoudoirs, cale reins et dossiers appui-tête en polyuréthane expansé. Toutes les parties indiquées sont couvertes par une couche de dacron. Coussins d'assise à densité différenciée: Partie supérieure 30 kg/m3 souple, partie inférieure 30 kg/m3 portante. Couche en dacron 350 gr/m2. Accoudoirs: Polyuréthane expansé 30 kg/m3 recouvert avec une couche de dacron 350 gr/m2.

Cale reins: Polyuréthane expansé 25 kg/m3 recouvert avec une couche de dacron 350 gr/m2. Dossiers appui-tête: Polyuréthane expansé 25 kg/m3 recouvert avec une couche de dacron 350 gr/m2.

Rembourrage de complément: densité 21 kg/m3.

RELEVEMENT Cuir ou microfibre non déhoussable. Pour les caractéristiques du revêtement aussi bien que pour l'entretien veuillez consulter les fiches techniques appropriées.

PIEDS En hêtre massif teinté avec vernis écologiques à base d'eau, dans les coloris wengés.

NOTE En version relax le modèle est réalisé exclusivement avec relax électrique ayant sa commande située sur la partie latérale extérieure de l'accoudoir, alors que les assises centrales sont équipées avec une pratique télécommande. Les éléments avec relax sont toujours séparés des éléments fixes et reliés avec un système à baïonnette. Les versions fixes sans relax sont en tout cas toujours équipées avec mécanique à crémaillère des appui tête.

VERSIONI CON MECCANISMO RELAX AZIONABILE SOLO ELETTRICAMENTE.

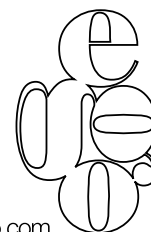
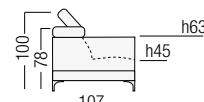
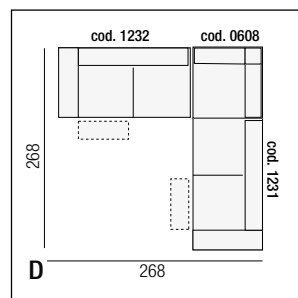
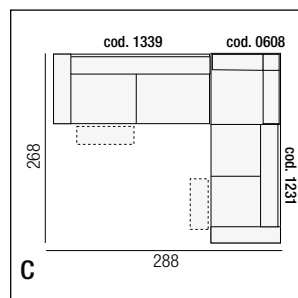
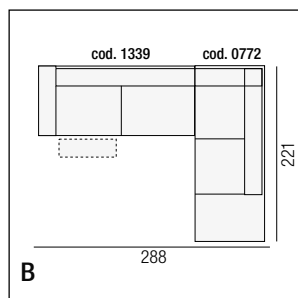
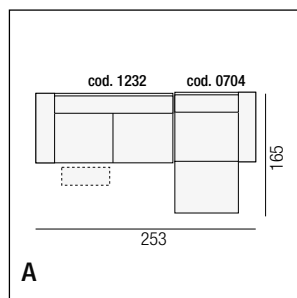
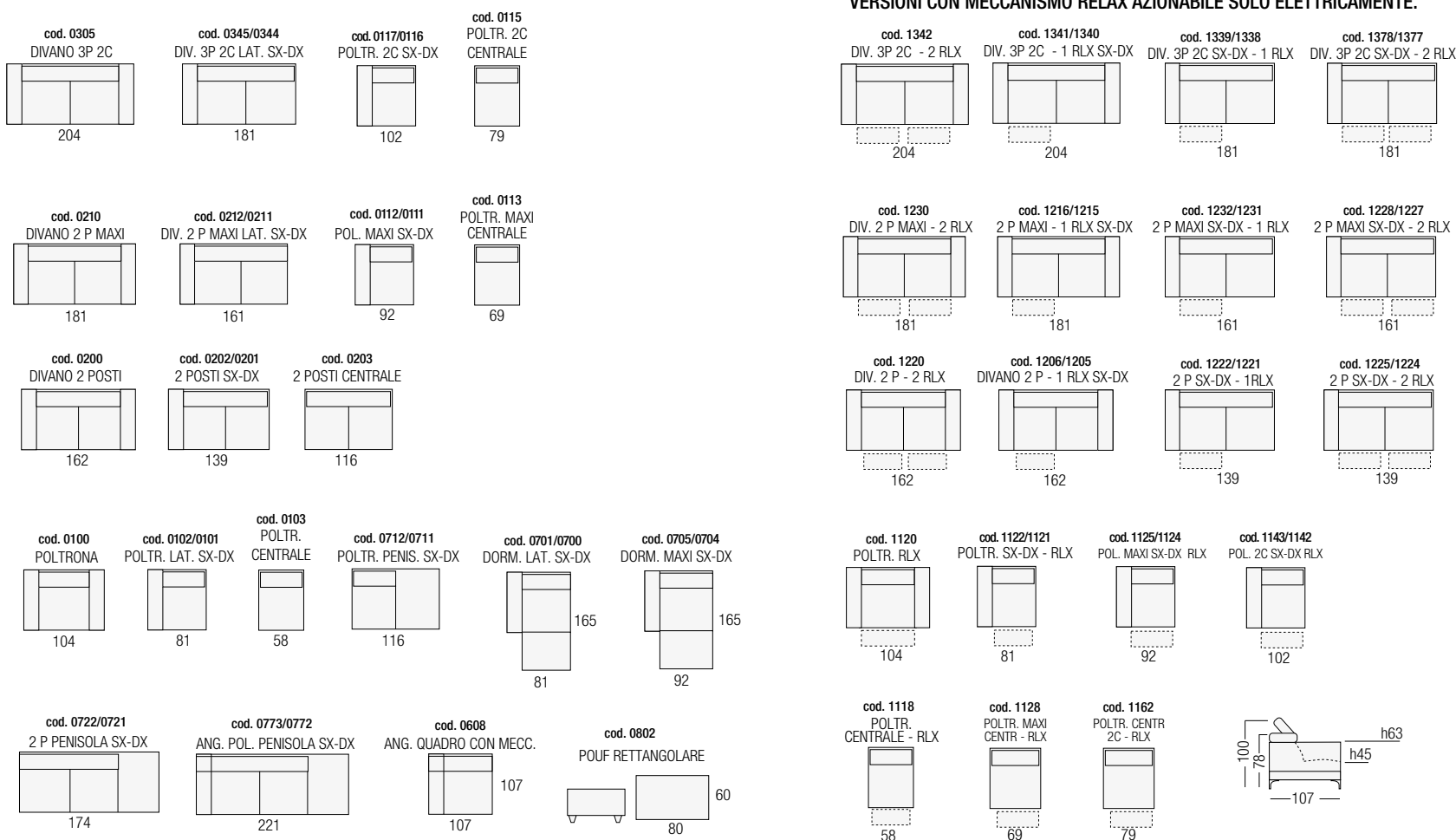

STRUTTURA Realizzata in legno abbinato a particelle di legno grezzo biodegradabile e pannelli di fibra di legno duro.

IMBOTTITURE Cuscini di seduta, braccioli, poggiatesta e spalliere poggiatesta reclinabili sono realizzate in poliuretano espanso a densità differenziate ricoperte da un materassino realizzato in piuma d'oca. Cuscini di seduta: densità 30 kg/mc.

Poggiatesta e poggiatesta: densità 23 kg/mc.

Braccioli: densità 30 kg/mc.

Imbottiture di completamento: densità 21 kg/mc.

RIVESTIMENTO Pelle, tessuto o microfibra. In tessuto, su richiesta, il modello è disponibile anche in versione sfoderabile. Si prega di fare riferimento al listino prezzi appropriato. Per le caratteristiche del rivestimento e della manutenzione vedere relative schede tecniche.

PIEDI In ABS da cm 3

NOTE Gli schienali sono dotati di meccanismo manuale a cricchetto, reclinabili a seconda del comfort desiderato.

Nelle versioni relax, con sedute dotate esclusivamente di motori elettrici, il movimento di apertura/chiusura della seduta è reso possibile agendo su semplici ed intuitivi pulsanti posti sui lati interni delle sedute.

Tutti gli elementi, sia fissi che con meccanismo relax sono modulari ed assemblabili tra di loro per mezzo di appositi agganci a baionetta.

FRAME Hard wood combined with plywood and particle board.

PADDING Seat cushion, armrest, kidney rest and inclining headrest in double density polyurethane foam covered with a layer of goose feathers.

Seat cushion: Polyurethane foam 30kg/m3.

Headrest and Kidney rests : Polyurethane foam 23kg/m3.

Armrests : Polyurethane foam 30kg/m3.

Frame padding: 21 kg/m3

COVERING Leather, fabric or Microfiber. In fabric, upon request, the model is also available with fully removable covers. Please refer to the appropriate price list. Not removable. Please check covering details for care instructions.

FEET In ABS H 3cm.

NOTE The backrests are equipped with manual ratchet mechanism, reclining according to the desired comfort.

In the relax versions, with seats fitted only with electric motors, the opening / closing movement is made possible by acting on the simple and intuitive buttons located on the inner sides of the seats.

All the elements, both fixed and with relax mechanism are modular and assembled by means of special bayonet hooks.

STRUCTURE En bois combiné avec du bois non traité et biodégradables et des panneaux de fibres de bois dur.

REMBOURRAGE Coussins d'assise, accoudoirs, cale-reins et dossiers appuie-tête inclinables réalisés en polyuréthane expansé à densité différenciée recouvert d'une couche de plumes d'oie.

Coussins d'assise: Polyuréthane expansé 30 Kg/m3.

Accoudoirs: Polyuréthane expansé 30 Kg/m3.

Appuie-tête et Cale-reins: Polyuréthane expansé 23 Kg/m3

Rembourrage de complément: densité 21 Kg/m3

REVETEMENT Cuir, tissu ou microfibre. En tissu, sur demande, le modèle est aussi disponible avec revêtement totalement déhoussable. Merci de vous référer au tarif correspondant. Pour les caractéristique du revêtement aussi bien que pour l'entretien veuillez consulter les fiches techniques appropriées.

PIEDS En ABS h 3 cm

NOTE Les dossiers ont un mécanisme à cliquet manuel, inclinables selon le confort souhaité. Dans les versions de relaxation, les assises sont équipés uniquement avec des moteurs électriques, le mouvement de l'ouverture / fermeture du siège est rendue possible en agissant sur les touches touch sensor situées sur les côtés intérieurs des assises. Tous les éléments, à la fois fixes et avec mécanisme de relaxation sont modulaires et assemblables par des crochets à baïonnette.

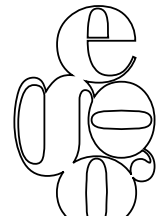
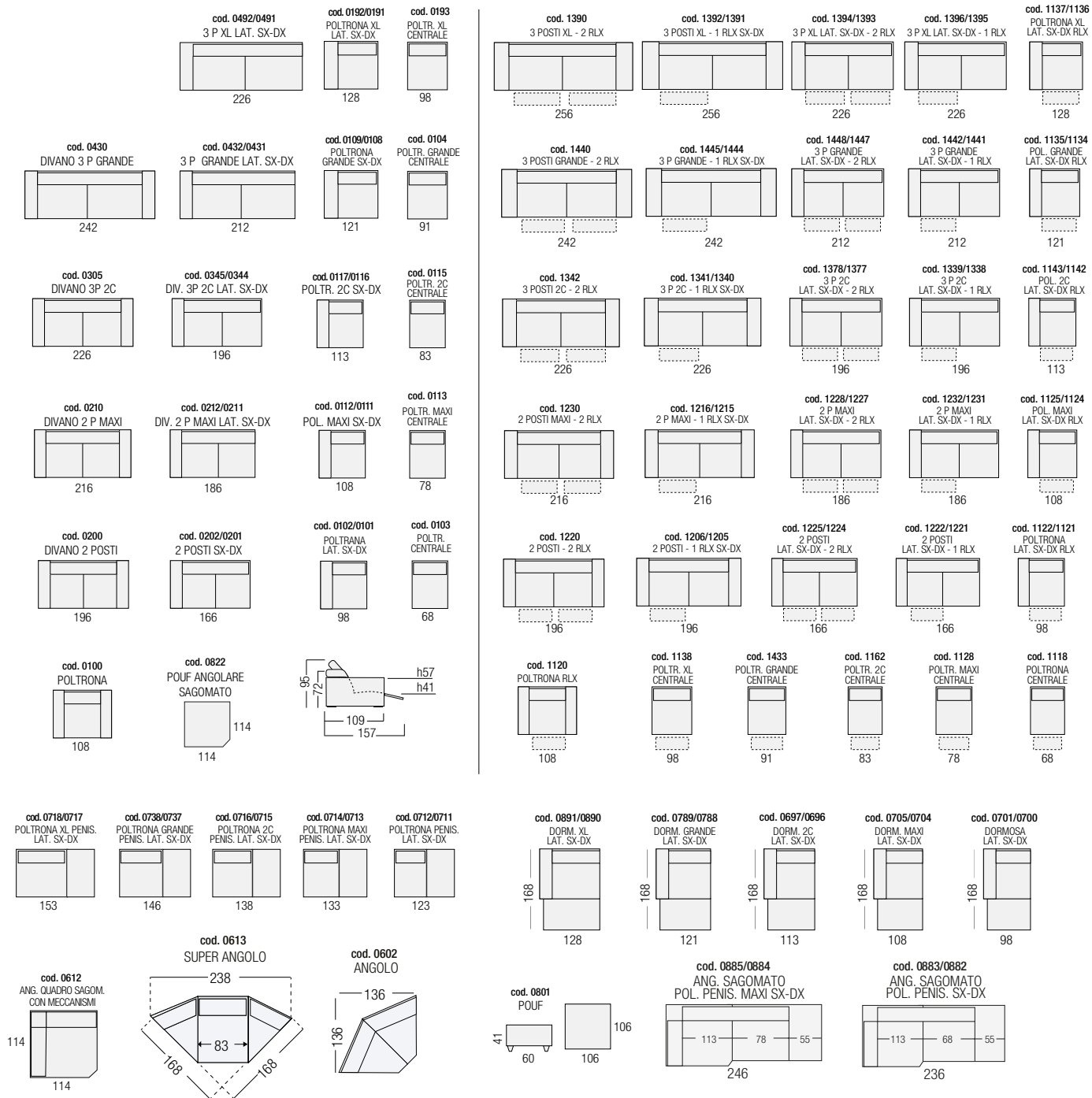

STRUTTURA Realizzata in legno abbinato a particelle di legno grezzo biodegradabile e pannelli di fibra di legno duro.

IMBOTTITURE Cuscini di seduta, braccioli e schienali sono realizzati in poliuretano espanso.

Tutte le parti sopraelencate sono ricoperte da una termofalda di dacron autoestinguente.

Cuscini di seduta: densità 30 kg/mc. Termofalda da 200 gr/mq.

Braccioli: densità 30 kg/mc. Termofalda da 200 gr/mq.

Schienali (poggiareni e poggiatesta): densità 23 kg/mc. Termofalda da 350 gr/mq.

Imbottiture di completamento: densità 21 kg/mc.

RIVESTIMENTO Pelle o microfibra non sfoderabile. Per le caratteristiche del rivestimento e della manutenzione vedere relative schede tecniche.

PIEDI Il modello è caratterizzato da elementi portanti posti a sostegno dei braccioli, realizzati in legno massello di frassino, nelle colorazioni rovere naturale o rovere noce canaletto. H alla base del divano: cm 15

NOTE Gli schienali sono dotati di meccanismo manuale a cricchetto, reclinabili a seconda del comfort desiderato.

FRAME Hardwood combined with plywood and particle board.

PADDING Seat cushions, armrests and backrests are made in polyurethane foam.

All of the above parts are covered with a Dacron layer.

Seat cushions: Polyurethane foam 30 kg/m3. Dacron layer 200 gr/m2.

Armrests: Polyurethane foam 30 kg/m3. Dacron layer 200 gr/m2.

Backrests (lumbar supports and headrests) : Polyurethane foam 30 kg/m3. Dacron layer 200 gr/m2.

Frame padding: 21 kg/m3

COVERING Leather or microfiber. Not removable. Please check covering details for care instructions.

FEET The model is characterized by a structure made of solid ash, available in the colors; natural oak or walnut canaletto. H to the base of the sofa: 15 cm.

NOTE Backrests are equipped with a manual adjustable mechanism, allowing to attain the desired comfort.

STRUCTURE En bois combiné avec du bois non traité et biodégradables et des panneaux de fibres de bois dur.

REMBOURRAGE Coussins d'assise, accoudoirs et dossiers en mousse de polyuréthane expansé. Toutes parties susdites sont recouvertes avec une couche de dacron.

Coussins d'assise: En polyuréthane expansé 30 kg/m3 recouvert de Dacron 200 gr/m2.

Accoudoirs: Polyuréthane expansé 30 kg/m3. Dacron 200 gr/m2.

Dossiers (cales reins et appui-tête): Polyuréthane expansé 23 kg/m3. Dacron 350/m2.

Rembourrage de complément: densità 21 kg/m3.

REVETEMENT Cuir ou microfibra non déhoussable. Pour les caractéristique du revêtement aussi bien que pour l'entretien veuillez consulter les fiches techniques appropriés.

PIEDS Le modèle est caractérisé par une structure portante en frêne massif, soutenant les accoudoirs dans les couleurs chêne naturel ou noyer canaletto. H à la base du canapé: 15 cm.

NOTES Les dossiers sont équipé avec un mécanisme manuel, inclinable selon le confort souhaité.

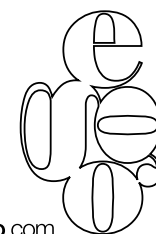
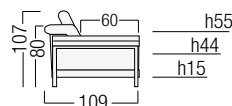
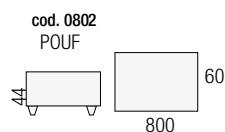
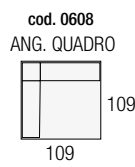
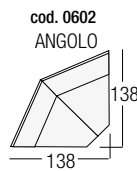
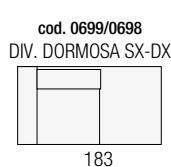
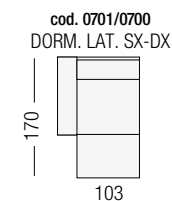
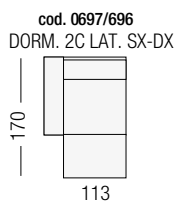
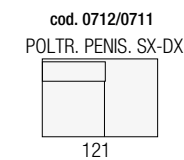
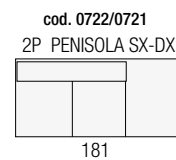
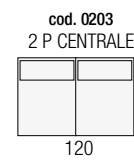
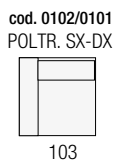
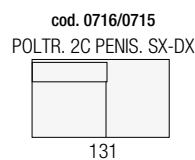
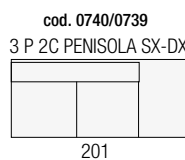
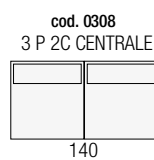
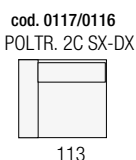
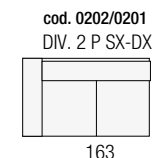
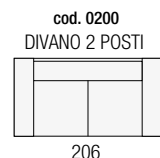
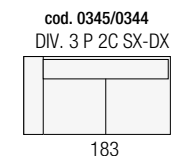
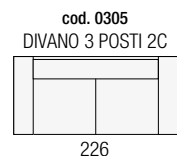
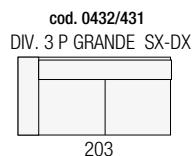
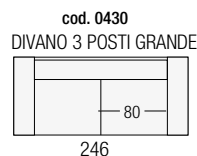

STRUTTURA Realizzata in legno abbinato a particelle di legno grezzo biodegradabile e pannelli di fibra di legno duro.

IMBOTTITURE Cuscini di seduta, braccioli e schienali sono realizzati in poliuretano espanso a densità differenziate, ricoperti da una termofalda di dacron autoestinguente.

Cuscini di seduta: densità 35 kg/mc. Termofalda da 350 gr/mq.

Braccioli : densità 40 kg/mc. Termofalda da 400 gr/mq.

Spalliere : densità 25 kg/mc. Termofalda in doppio strato: inferiore da 200 gr/mq , superiore da 350 gr/mq.

Poggiatesta : densità 25 kg/mc. Termofalda da 350 gr/mq.

Imbottiture di completamento: densità 21 kg/mc.

RIVESTIMENTO Pelle o microfibra non sfoderabile. Per le caratteristiche del rivestimento e della manutenzione vedere relative schede tecniche.

PIED realizzati in metallo con finitura in vernice epossidica colore grigio ombra o testa di moro, in metallo cromato con finitura cromo lucido o titanio. Variante in legno massello di faggio evaporato, tinto color noce toffee. H: cm 13

NOTE Il modello, sia nelle versioni relax che in quelle fisse, è dotato di schienali ad altezza variabile sino ad un massimo di cm 18, regolabili tramite motori elettrici posti all'interno del divano. I motori sono azionabili con semplici ed intuitivi pulsanti posti sui lati interni delle sedute.

Nelle versioni relax , con sedute dotate esclusivamente di motori elettrici, accanto ai pulsanti che agiscono sugli schienali, vi sono quelli che comandano la regolazione di apertura/chiusura della seduta.

Il movimento delle sedute è indipendente da quello degli schienali. Sedute e schienali motorizzati, con la loro azione combinata possono assecondare qualsiasi esigenza di comfort.

Tutti gli elementi, sia fissi che con meccanismo relax sono modulari ed assemblabili tra di loro per mezzo di appositi agganci a baionetta.

FRAME Hardwood combined with plywood and particle board.

PADDING Seat cushion, armrests and backrests are made in polyurethane foam with varying density. All of the above parts are covered with a Dacron layer.

Seat cushions: Polyurethane foam 35 kg/m3. Dacron layer 350 gr/m2.

Armrests: Polyurethane foam 40 kg/m3. Dacron layer 400 gr/m2.

Backrests: Polyurethane foam 25 kg/m3. Double Dacron layer: Upper part part 350 gr/m2, lower part 200 gr/m2

Lumbar supports: Polyurethane foam 25 kg/m3. Dacron layer 350 gr/m2.

Frame padding: 21 kg/m3

COVERING Leather or microfiber. Not removable. Please check covering details for care instructions.

FEET In metal with epoxy powder finish, coloured shadow grey o dark brown; in chromed metal available in steel or titanium finish. Wooden legs also available. Made of solid evaporated beech coloured walnut or toffee. H 13 cm.

NOTE The model is always equipped with variable height backrests up to a maximum of 18 cm, adjustable by electric motors located inside the sofa. The engines can be operated with simple and intuitive buttons located on the inner sides of the seats.

Relax versions have seats fitted with electric motors only, and its controls are placed next to the buttons that act on the backrests.

The seats movement is independent of that of the backrests. Motorized seats and backs, with their combined action can satisfy any need of comfort.

All the elements, both fixed and with relax mechanism, are modular and can be assembled by means of a bayonet fixing hook.

STRUCTURE En bois, multiples et particules habillés d'une couche de dacron.

REMBOURRAGE Coussins d'assise, accoudoirs, et dossiers en polyuréthane expansé à double densité. Toutes parties susdites sont recouvertes avec une couche de dacron.

Coussins d'assise : Polyuréthane expansé 35 kg/m3. Dacron 350 gr/m2.

Accoudoirs: Polyuréthane expansé 40 kg/m3. Dacron 400 gr/m2.

Dossiers : Polyuréthane expansé 25 kg/m3. Dacron en double couche : Inférieure 200gr/m2, supérieure 350 gr/m2.

Cales-reins : Polyuréthane expansé 25 kg/m3. Dacron 350 gr/m2.

Rembourrage de complément : densité 21 kg/m3.

RETEMENT Cuir ou microfibre non déhoussable. Pour les caractéristique du revêtement aussi bien que pour l'entretien veuillez consulter les fiches techniques appropriés.

PIEDS En métal finition peinture à poudre époxy coloris gris ombre ou marron foncé, disponible finition chromée dans les couleurs acier ou titane. Version en bois de hêtre évaporé teinté noyer ou toffee. H 13 cm.

NOTES Le modèle, en version relax ou en version fixe, est équipé de dossiers ayant une hauteur variable jusqu'à un maximum de 18 cm, réglable par des moteurs électriques situés à l'intérieur du canapé. Les moteurs peuvent être actionnés par des boutons simples et intuitifs situés sur les côtés intérieurs des assises.

Dans les versions relax, les assises sont équipés uniquement avec des moteurs électriques, à côté des boutons qui agissent sur les dossiers, il ya ceux qui contrôlent le réglage de l'ouverture / fermeture de l'assise.

Le mouvement des assises est indépendant de celui des dossiers. Assises et dossiers motorisés, avec leur action combinée peuvent satisfaire toutes les exigences de confort.

Tous les éléments, à la fois fixe et avec un mécanisme de relaxation sont modulaires et peuvent être assemblés entre eux au moyen d'un crochet de fixation à baionnette.

N.B. LE SEDUTE SENZA MOTORE RELAX DEVONO ESSERE COMUNQUE DOTATE DI MOTORE LIFT

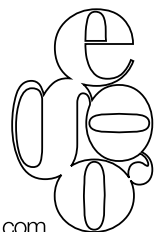
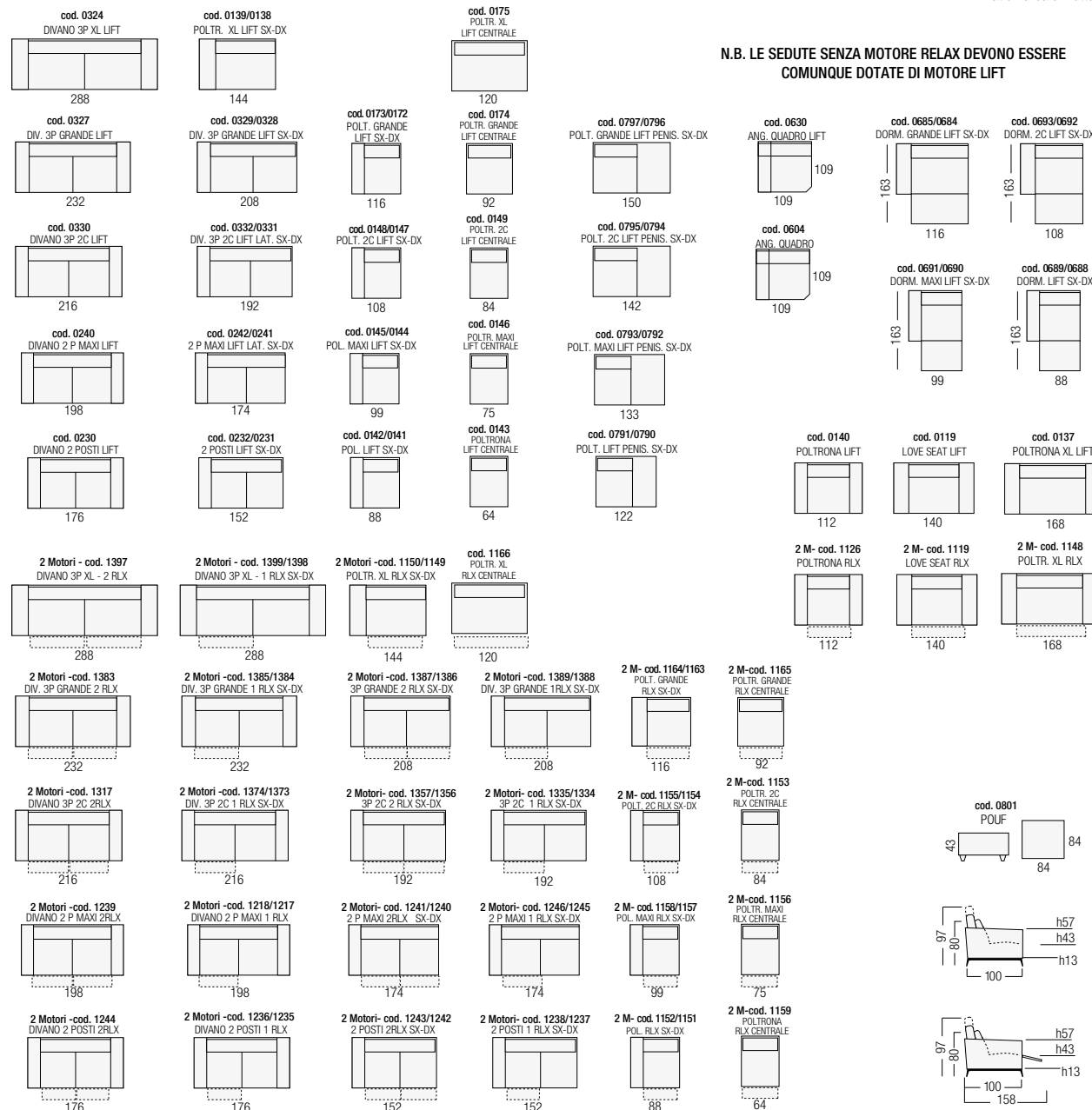

STRUTTURA Realizzata in legno abbinato a particelle di legno grezzo biodegradabile e pannelli di fibra di legno duro.

IMBOTTITURE Cuscini di seduta, braccioli, poggiatesta e spalliere poggiatesta reclinabili sono realizzate in poliuretano espanso. Tutte le parti sopraelencate sono ricoperte da una termofalda di dacron autoestinguente.

Cuscini di seduta: densità 30 kg/mc soffice, ricoperti da una termofalda da 200 gr/mq.

Braccioli: densità 30 kg/mc soffice, ricoperti da una termofalda da 200 gr/mq.

Poggiatesta: densità 23 kg/mc. Termofalda da 350 gr/mq.

Imbottiture di completamento: densità 21 kg/mc.

RIVESTIMENTO Pelle o microfibra non sfoderabile. Per le caratteristiche del rivestimento e della manutenzione vedere relative schede tecniche.

PIEDI In legno massello di faggio evaporato tinto con vernici ecologiche ad acqua, color noce TOFFEE, con inserto portante in acciaio color titanio. H. 13

NOTE Nella versione relax il modello è dotato esclusivamente di meccanismo elettrico con comando posizionato sul lato interno del divano tra seduta e bracciolo, mentre le sedute centrali sono dotate di comandi "touch sensor" posti sul fianco interno della seduta. Gli elementi relax sono sempre staccati da quelli fissi e vengono agganciati con apposito sistema a baionetta. In tutte le versioni, sia fisse che relax, è presente il cricchetto nelle testiere che è regolabile manualmente e permette di creare l'assetto ideale a seconda del tipo di comfort desiderato.

FRAME Hardwood combined with plywood and particle board.

PADDING Seat cushion, armrests, lumbar supports, backrests and headrests are made in polyurethane foam with varying density. All of the above parts are covers with a Dacron layer.

Seat cushions: Polyurethane foam 40 kg/m3. Dacron layer 200 gr/m2.

Armrest: Polyurethane foam 40 kg/m3. Dacron layer 200 gr/m2.

Lumbar support: 23 kg/m3. Dacron layer 350 gr/m2.

Backs and headrests: 23 kg/m3. Dacron layer 350 gr/m2.

Frame padding: 21 kg/m3

COVERING Leather or microfiber. Not removable. Please check covering details for care instructions.

FEET In beech wood stained with ecological water based paints, available in walnut or Toffee colour, with supporting inlay metal bar in titanium colour. H. 13 cm

NOTE When with recliner seats, the model is always equipped with electric mechanisms. Control panel are placed on the inside part of the armrest. The central seats, when recliner, are equipped with "touch sensor" buttons placed on the seat side. Recliner elements are always detached from fixed elements and can be assembled by means of a bayonet fixing hook.

Headrests are always equipped with manual adjustable mechanism.

STRUCTURE En bois combiné avec du bois non traité et biodégradables et des panneaux de fibres de bois dur.

REMBOURRAGE Coussins d'assise, accoudoirs, et dossiers en polyuréthane expansé à double densité. Toutes parties susdites sont recouvertes avec une couche de dacron.

Coussins d'assise : Polyuréthane expansé 30 kg/m3 . Dacron 200 gr/m2.

Accoudoirs : Polyuréthane expansé 30 kg/m3 . Dacron 200 gr/m2.

Cales-reins : 23 kg/m3. Dacron 350 gr/m2.

Dossiers et appuie-tête : 23 kg/m3. Dacron 350/m2.

Rembourrage de complément : densité 21 kg/m3.

RETEVEMENT Cuir ou microfibre non déhoussable. Pour les caractéristique du revêtement aussi bien que pour l'entretien veuillez consulter les fiches techniques appropriés.

PIEDS En bois de hêtre évaporé teinté avec peintures à l'eau écologique, disponible en coloris noyer et toffee, avec un détail en en acier coloris titanium. H 13 cm.

NOTES Dans les versions relax, les assises sont équipés uniquement avec des moteurs électriques avec commandes situées sur le côté interne des accoudoirs, alors que les assises centrales sont équipées avec des boutons « touch sensor » placés sur côté interne de l'assise. Les éléments ave relax sont toujours séparés et peuvent être assemblés entre eux au moyen d'un crochet de fixation à baionnette.

Toute version est toujours équipée d'un mécanisme de réglage des têtes manuelle qui permet de trouver la position de confort souhaité.

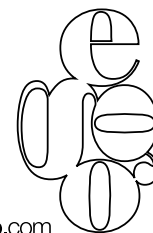
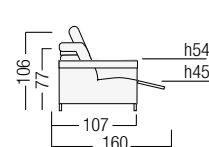
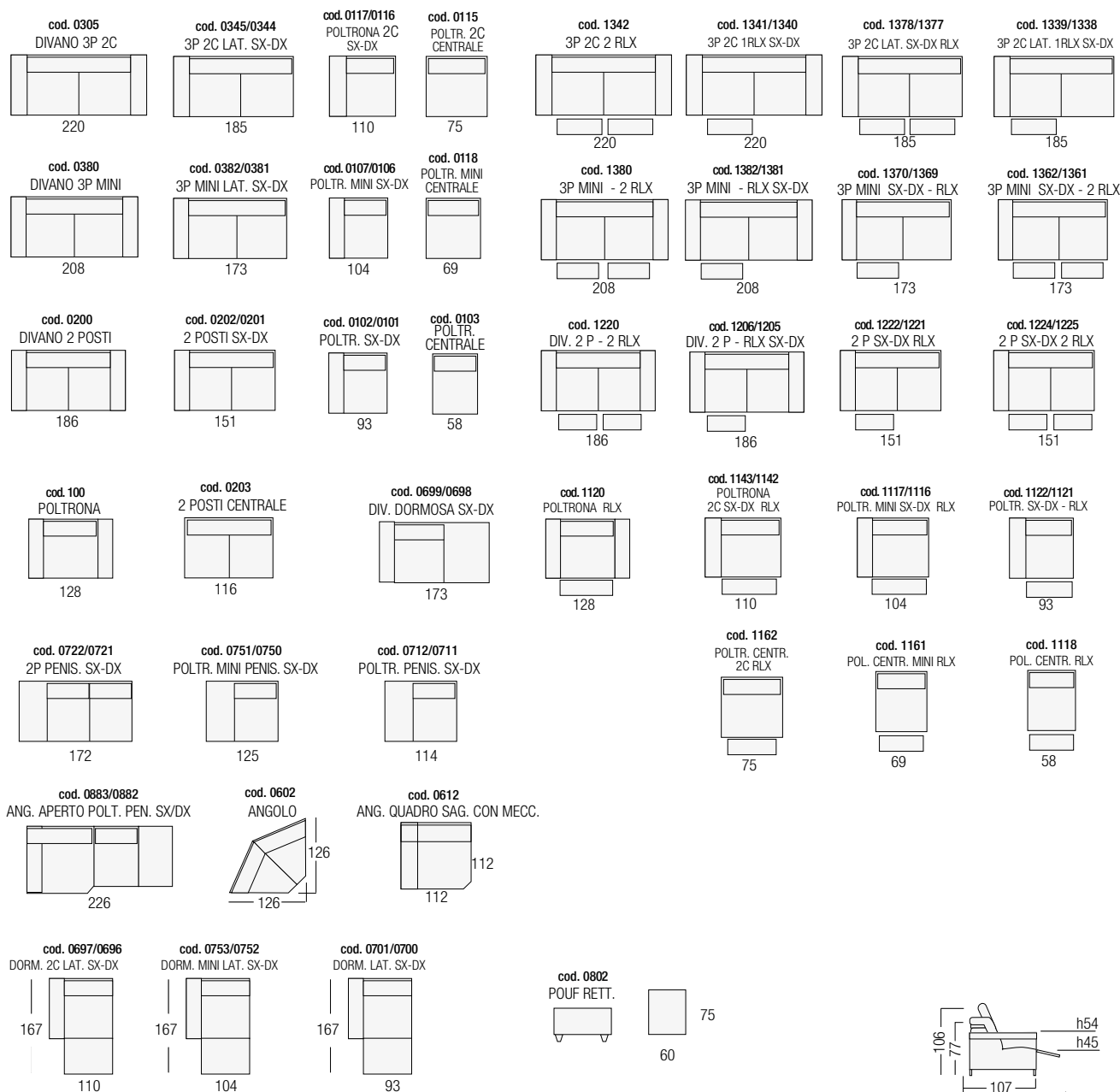

STRUTTURA Realizzata in legno abbinato a particelle di legno grezzo biodegradabile e pannelli di fibra di legno duro.

IMBOTTITURE Cuscini di seduta, braccioli, poggiatesta e spalliere poggiatesta reclinabili sono realizzate in poliuretano espanso. Tutte le parti sopraelencate sono ricoperte da una termofalda di dacron autoestingente.

Cuscini di seduta a densità differenziata: parte superiore di densità 25 kg/mc soffice, parte inferiore di densità 30 kg/mc portante, ricoperti da una termofalda da 100 gr/mq.

Braccioli: densità 30 kg/mc. Termofalda da 200 gr/mq.

Poggiatesta: densità 25 kg/mc. Termofalda da 350 gr/mq.

Spalliere poggiatesta: densità 25 kg/mc. Termofalda da 350 gr/mq.

Imbottiture di completamento: densità 21 kg/mc.

RIVESTIMENTO Pelle non sfoderabile, microfibra o tessuto sfoderabile. Per le caratteristiche del rivestimento e della manutenzione vedere relative schede tecniche.

PIEDI realizzati in metallo nelle finiture titanio o ottone spazzolato. H: cm. 13.

NOTE le versioni letto sono dotate di reti a due pieghe elettrosaldate, realizzate in acciaio ad alta resistenza, verniciate a forno con polveri epossidiche.

Reti : divano 3 posti: 180 x 201; divano 2 posti maxi:

160 x 201; 2 posti: 140 x 201; poltrona: 90 x 201.

Materassi : in poliuretano espanso divano 3 posti: 160 x 193 x 13; divano 2 posti maxi: 140 x 193 x 13; divano 2 posti: 120 x 193 x 13; poltrona: 70 x 193 x 13.

FRAME Hardwood combined with plywood and particle board.

PADDING Seat cushion, armrests, lumbar supports and backrests-headrests are made in polyurethane foam. Every part mentioned is covered with a layer of self extinguishing dacron.

Seat cushions with varying density: Upper part 25 kg/m3 soft, bottom part 30 kg/m3 supporting. Dacron layer 100 gr/m2.

Armrests: Polyurethane foam 30 kg/m3 with part in density 40 kg/m3. Dacron layer 200 gr/m2.

Lumbar supports: Polyurethane foam 25 kg/m3. Dacron layer 350 gr/m2.

Backrests-headrests: Polyurethane foam 25 kg/m3. Dacron layer 350 gr/m2.

Frame padding: Polyurethane foam 21 kg/m3.

COVER Leather not removable. Fabric or microfiber fully removable. Please check covering details for care instructions.

FEET Metal finishes in titanium or brushed brass. H 13 cm.

NOTE Bed versions are equipped with two folds electro-welded bed mechanisms made of steel painted with epoxy powder finishes baked.

Mechanisms: 3 seater 180 x 201 ; 2 seater maxi 160 x 201 ; 2 seater 140 x 201 ; Armchair 90 x 201.

Mattress : in polyurethane foam 3 seater 160 x 193 x 13 ; 2 seater maxi 140 x 193 x 13 ; 2 seater 120 x 193 x 13 ; Armchair 70 x 193 x 13.

STRUCTURE En bois, multiplés et particules habillés d'une couche de dacron.

REMBOURRAGE Coussins d'assise, accoudoirs, cale reins et dossiers appui-tête en polyuréthane expansé.

Toutes les parties indiquées sont couvertes par une couche de dacron autoextinguible.

Coussins d'assise à densité différenciée: Partie supérieure 25 kg/m3 souple, partie inférieure 30 kg/m3 portante. Couche en dacron 100 gr/m2.

Accoudoirs: Polyuréthane expansé 30 kg/m3 avec parties en densité 40 kg/mc recouvert avec une couche de dacron 200 gr/m2.

Cale reins: Polyuréthane expansé 25 kg/m3 recouvert avec une couche de dacron 350 gr/m2.

Dossiers appui-tête: Polyuréthane expansé 25 kg/m3 recouvert avec une couche de dacron 350 gr/m2.

Rembourrage de complément : densité 21 kg/m3.

REVETEMENT Cuir non déhoussable. Microfibre ou tissu déhoussable. Pour les caractéristiques du revêtement aussi bien que pour l'entretien veuillez consulter les fiches techniques appropriées.

PIEDS Finitions métalliques en titane ou en laiton brossé. H 13 cm.

NOTE Les versions lit sont équipées avec sommier deux plis électro-soudé, réalisé en acier à haute résistance, peint avec des poudres époxy au four. Sommier : 3 places 180 x 201 ; 2 places maxi 160 x 201 ; 2 places 140 x 201 ; Fauteuil 90 x 201.

Matelas : en polyuréthane 3 places 160 x 193 x 13 ; 2 places maxi 140 x 193 x 13 ; 2 places 120 x 193 x 13 ; Fauteuil 70 x 193 x 13.

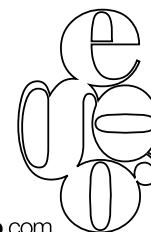
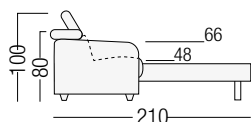
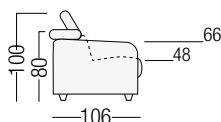
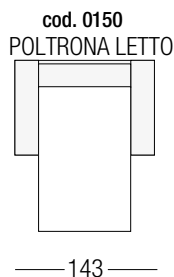
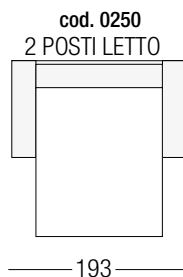
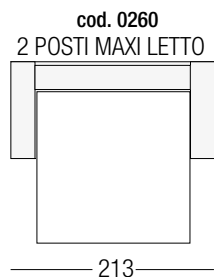
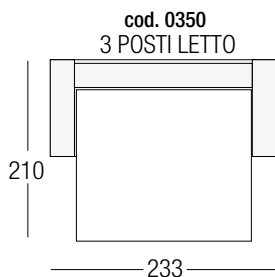
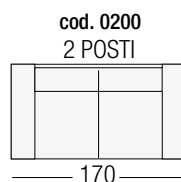
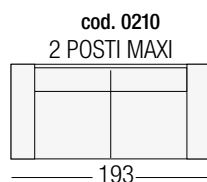
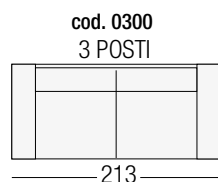
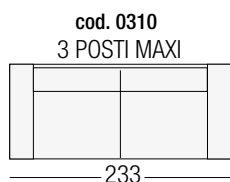

STRUTTURA Realizzata in legno abbinato a particelle di legno grezzo biodegradabile e pannelli di fibra di legno duro.

IMBOTTITURE Cuscini di seduta, braccioli e schienali sono realizzati in poliuretano espanso a densità differenziate, ricoperti da una termofalda di dacron autoestinguente.

Cuscini di seduta: densità 35 kg/mc. Termofalda da 350 gr/mq.

Braccioli: densità 30 kg/mc. Termofalda da 350 gr/mq.

Spalliere: densità 25 kg/mc. Termofalda in doppio strato: inferiore da 200 gr/mq, superiore da 350 gr/mq.

Poggiareni: densità 25 kg/mc. Termofalda da 350 gr/mq.

Imbottiture di completamento: densità 21 kg/mc.

RIVESTIMENTO Pelle o microfibra non sfoderabile. Per le caratteristiche del rivestimento e della manutenzione vedere relative schede tecniche.

PIEDI realizzati in metallo nelle finiture titanio o ottone spazzolato. H: cm 13

NOTE Il modello, sia nelle versioni relax che in quelle fisse, è dotato di schienali ad altezza variabile sino ad un massimo di cm 18, regolabili tramite motori elettrici posti all'interno del divano. I motori sono azionabili con semplici ed intuitivi pulsanti posti sui lati interni delle sedute.

Nelle versioni relax, con sedute dotate esclusivamente di motori elettrici, accanto ai pulsanti che agiscono sugli schienali, vi sono quelli che comandano la regolazione di apertura/chiusura della seduta.

Il movimento delle sedute è indipendente da quello degli schienali. Sedute e schienali motorizzati, con la loro azione combinata possono assecondare qualsiasi esigenza di comfort.

Tutti gli elementi, sia fissi che con meccanismo relax sono modulari ed assemblabili tra di loro per mezzo di appositi agganci a baionetta.

FRAME Hardwood combined with plywood and particle board.

PADDING Seat cushion, armrests and backrests are made in polyurethane foam with varying density. All of the above parts are covered with a Dacron layer.

Seat cushions: Polyurethane foam 35 kg/m3. Dacron layer 350 gr/m2.

Armrests: Polyurethane foam 30 kg/m3. Dacron layer 350 gr/m2.

Backrests and Lumbar supports: 25 kg/m3. Dacron layer 350 gr/m2.

Frame padding: 21 kg/m3

COVERING Leather or microfiber. Not removable. Please check covering details for care instructions.

FEET In metal available either in titanium finish or brushed brass. H 13 cm.

NOTE The model is always equipped with variable height backrests up to a maximum of 18 cm, adjustable by electric motors located inside the sofa. The engines can be operated with simple and intuitive buttons located on the inner sides of the seats.

Relax versions have seats fitted with electric motors only, and its controls are placed next to the buttons that act on the backrests.

The seats movement is independent of that of the backrests. Motorized seats and backs, with their combined action can satisfy any need of comfort.

All the elements, both fixed and with relax mechanism, are modular and can be assembled by means of a bayonet fixing hook.

STRUCTURE En bois, multiples et particules habillés d'une couche de dacron.

REMBOURRAGE Coussins d'assise, accoudoirs, et dossiers en polyuréthane expansé à double densité. Toutes parties susdites sont recouvertes avec une couche de dacron.

Coussins d'assise: Polyuréthane expansé 35 kg/m3. Dacron 350 gr/m2.

Accoudoirs: Polyuréthane expansé 35 kg/m3. Dacron 350 gr/m2.

Dossiers et Cales-reins: 30 kg/m3. Dacron 350 gr/m2.

appuie-tête: Polyuréthane expansé 25 kg/m3. Dacron 350/m2.

Rembourrage de complément: densité 21 kg/m3.

RETEVEMENT Cuir ou microfibre non déhoussable. Pour les caractéristique du revêtement aussi bien que pour l'entretien veuillez consulter les fiches techniques appropriés.

PIEDS En métal disponible dans les couleurs Titane ou Cuivre brossé, H 13 cm.

NOTES Le modèle, en version relax ou en version fixe, est équipé de dossiers ayant une hauteur variable jusqu'à un maximum de 18 cm, réglable par des moteurs électriques situés à l'intérieur du canapé. Les moteurs peuvent être actionnés par des boutons simples et intuitifs situés sur les côtés intérieurs des assises. Dans les versions relax, les assises sont équipés uniquement avec des moteurs électriques, à côté des boutons qui agissent sur les dossiers, il ya ceux qui contrôlent le réglage de l'ouverture / fermeture de l'assise. Le mouvement des assises est indépendant de celui des dossiers. Assises et dossiers motorisés, avec leur action combinée peuvent satisfaire toutes les exigences de confort.

Tous les éléments, à la fois fixe et avec un mécanisme de relaxation sont modulaires et peuvent être assemblés entre eux au moyen d'un crochet de fixation à baïonnette.

N.B. LE SEDUTE SENZA MOTORE RELAX DEVONO ESSERE COMUNQUE DOTATE DI MOTORE LIFT

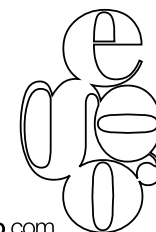
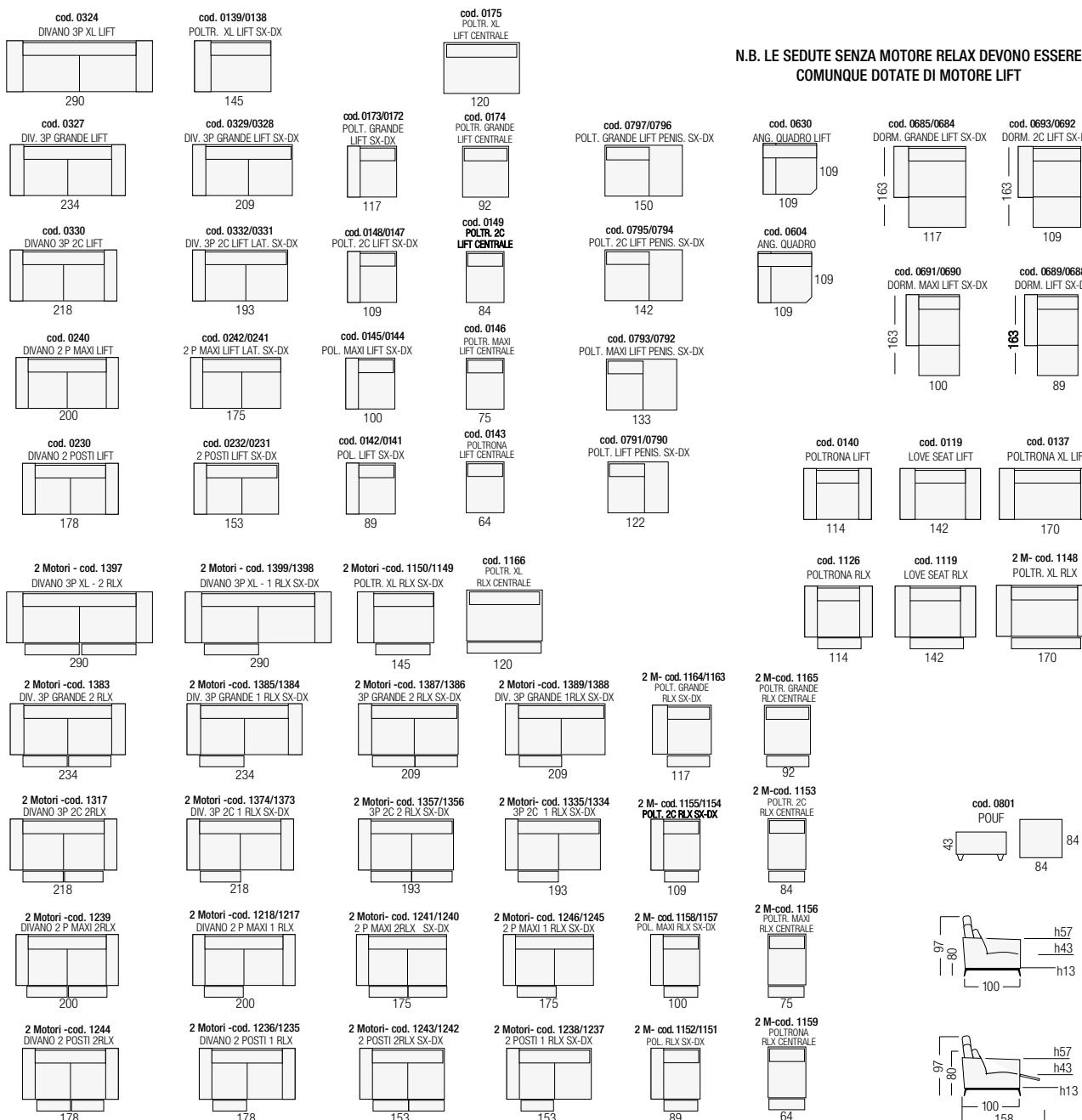

STRUTTURA Realizzata in legno abbinato a particelle di legno grezzo biodegradabile e pannelli di fibra di legno duro.

IMBOTTITURE Cuscini di seduta, braccioli, poggiatesta e schienali sono realizzati in poliuretano espanso a densità differenziate ricoperte da un materassino realizzato in piuma d'oca.

Cuscini di seduta: densità 30 kg/mc.

Poggiatesta e poggiatesta: densità 23 kg/mc.

Imbottiture di completamento: densità 21 kg/mc.

Braccioli: densità 30 kg/mc.

RIVESTIMENTO Pelle, tessuto o microfibra. In tessuto, su richiesta, il modello è disponibile anche in versione sfoderabile. Si prega di fare riferimento al listino prezzi appropriato. Per le caratteristiche del rivestimento e della manutenzione vedere relative schede tecniche.

PIEDI in acciaio finitura cromo o titanio. H cm 14,5

NOTE Gli schienali sono dotati di meccanismo manuale a cricchetto, reclinabili a seconda del comfort desiderato.

FRAME Hard wood combined with plywood and particle board.

PADDING Seat cushion, armrest, kidney rest and inclining headrest in double density polyurethane foam covered with a layer of goose feathers.

Seat cushion: Polyurethane foam 30kg/m3.

Headrest and Kidney rests : Polyurethane foam 23kg/m3.

Armrests : Polyurethane foam 30kg/m3.

Frame padding: 21 kg/m3

COVERING Leather, fabric or Microfiber. In fabric, upon request, the model is also available with fully removable covers. Please refer to the appropriate price list.

Please check covering details for care instructions.

FEET In metal color chrome or Titanium H 14.5 cm

NOTE The backrests are equipped with manual ratchet mechanism, reclining according to the desired comfort.

STRUCTURE En bois combiné avec du bois non traité et biodégradables et des panneaux de fibres de bois dur.

REMBOURRAGE Coussins d'assise, accoudoirs, cale-reins et dossiers appui-tête inclinables réalisés en polyuréthane expansé à densité différenciée recouvert d'une couche de plumes d'oie.

Coussins d'assise: Polyuréthane expansé 30 Kg/m3.

Accoudoirs: Polyuréthane expansé 30 Kg/m3.

Appuie-tête et Cale-reins: Polyuréthane expansé 23 Kg/m3

Rembourrage de complément: densité 21 Kg/m3

RETEVEMENT Cuir, tissu ou microfibre. En tissu, sur demande, le modèle est disponible avec revêtement totalement déhoussable. Merci de vous référer au tarif correspondant. Pour les caractéristique du revêtement aussi bien que pour l'entretien veuillez consulter les fiches techniques appropriées.

PIEDS En acier couleur chromé ou Titanium H 14.5

NOTE Les dossiers ont un mécanisme à cliquet manuel, inclinables selon le confort souhaité.

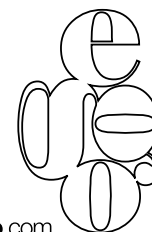
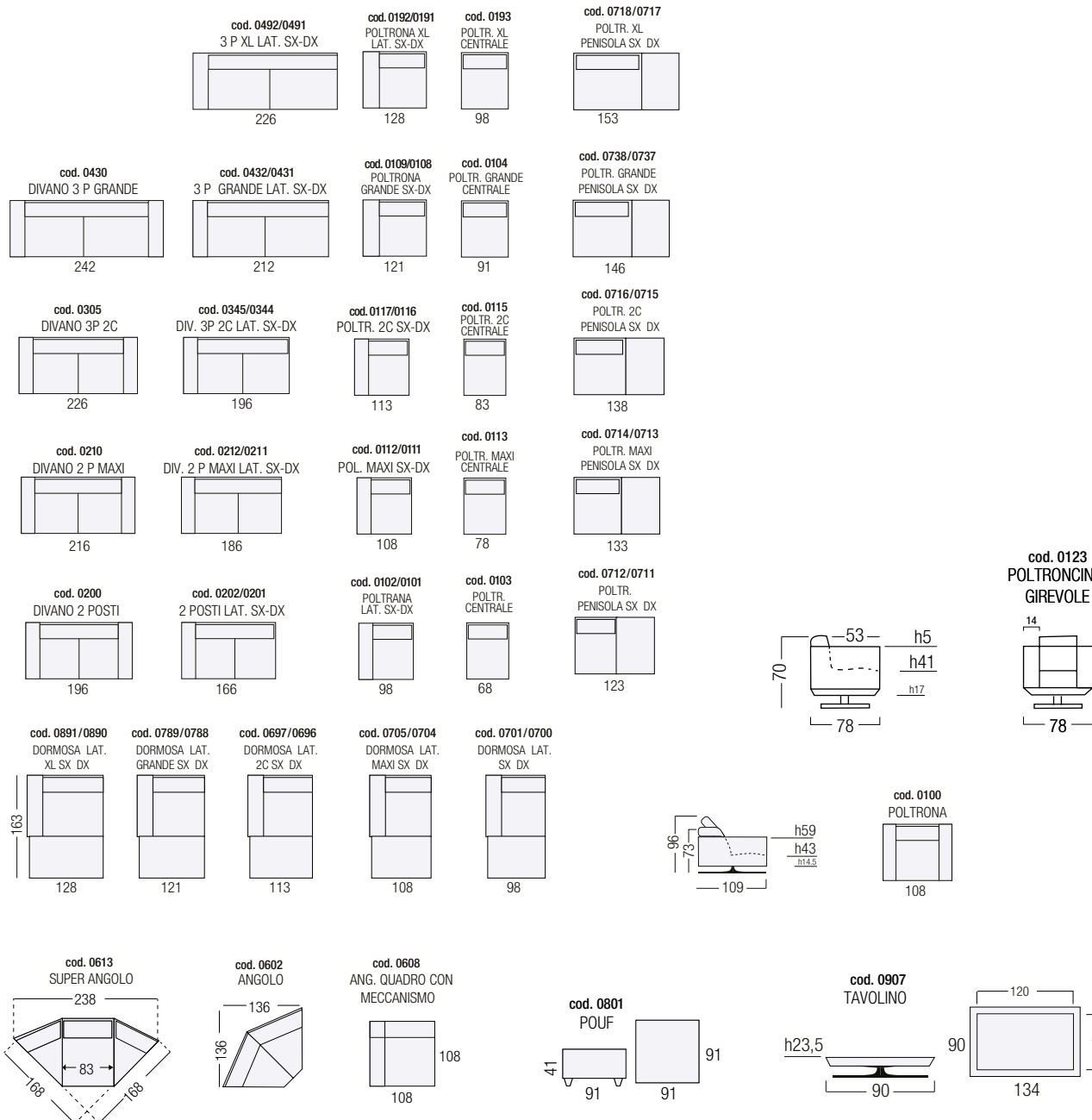

Pouf contenitore con struttura in legno ed interno foderato. Il pouf Tonder è rivestito in pelle con una placca in cuoio e clip laccate. Questa placca ha la funzione di sigillare Tonder una volta utilizzato come contenitore, ed aiuta a tenere fermo e stabile il cuscino di seduta. La fascia circolare inferiore e la placca di chiusura sono in color cuoio, mentre il cuscino di seduta e la fascia più grande intermedia possono essere personalizzati con altre pelli e colori.

Footstool with container made with wooden frame and lined interior. The Tonder Footstool is upholstered in leather with a leather plate and lacquered clips. This plate serves to seal the Tonder top, and helps to hold in place the seat cushion. The lower circular band and the closing plate are in leather, while the seat cushion and the largest middle cover can be customized with other leathers and colours.

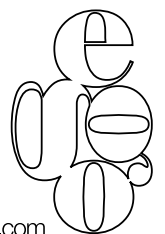
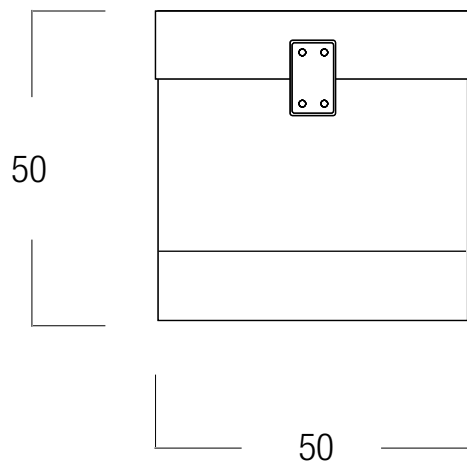

STRUTTURA Realizzata in legno abbinato a particelle di legno grezzo biodegradabile e pannelli di fibra di legno duro.

IMBOTTITURE Cuscini di seduta, braccioli, poggiatesta e spalliere poggiatesta reclinabili sono realizzate in poliuretano espanso. Tutte le parti sopraelencate sono ricoperte da una termofalda di dacron autostinguente.

Cuscini di seduta a densità differenziata: parte superiore di densità 30 kg/mc soffice, parte inferiore di densità 30 kg/mc portante, ricoperti da una termofalda da 350 gr/mq.

Braccioli: densità 30 kg/mc. Termofalda da 350 gr/mq.

Poggiatesta: densità 25 kg/mc. Termofalda da 350 gr/mq.

Spalliere poggiatesta: densità 25 kg/mc. Termofalda da 350 gr/mq.

Imbottiture di completamento: densità 21 kg/mc.

RIVESTIMENTO Pelle o microfibra non sfoderabile. Per le caratteristiche del rivestimento e della manutenzione vedere relative schede tecniche.

PIEDI In metallo finitura cromo o titanio. H cm 13

NOTE Nella versione relax il modello è dotato esclusivamente di meccanismo elettrico con comando posizionato sul lato esterno del divano, mentre le sedute centrali sono dotate di pulsanti touch control inseriti sul fianco della seduta stessa.

Gli elementi relax sono sempre

staccati da quelli fissi e vengono agganciati con apposito sistema a baionetta.

Nelle versioni fisse senza meccanismo relax in ogni caso è presente il cricchetto manuale nelle testiere.

FRAME Hardwood combined with plywood and particle board.

PADDING Seat cushion, armrests, lumbar supports and backrests-headrests are made in polyurethane foam. Every part mentioned is covered by a Dacron layer. Seat cushions with varying density: Upper part 30 kg/m3 soft, bottom part 30 kg/m3 supporting. Dacron layer 350 gr/m2.

Armrests: Polyurethane foam 30 kg/m3. Dacron layer 350 gr/m2.

Lumbar supports: Polyurethane foam 25 kg/m3. Dacron layer 350 gr/m2.

Backrests-headrests: Polyurethane foam 25 kg/m3. Dacron layer 350 gr/m2.

Frame padding: Polyurethane foam 21 kg/m3.

COVERING Leather or microfiber. Not removable. Please check covering details for care instructions.

FEET In metal colour chrome or titanium, H 13 cm.

NOTE The relax version comes with electric movements only. Controls are placed on the armrest side, whilst armless units are equipped with practical touch sensor buttons placed on the side of the seat cushion itself. Elements with relax mechanism always delivered separately and connected to the fixed parts by made for purpose bayonet fittings. Fixed versions are always equipped with mechanical headrests mechanism.

STRUCTURE En bois, multiples et particules habillés d'une couche de dacron.

REMBOURRAGE Coussins d'assise, accoudoirs, cale reins et dossiers appui-tête en polyuréthane expansé.

Toutes les parties indiquées sont couvertes par une couche de dacron.

Coussins d'assise à densité différenciée: Partie supérieure 30 kg/m3 souple, partie inférieure 30 kg/m3 portante. Couche en dacron 350 gr/m2.

Accoudoirs: Polyuréthane expansé 30 kg/m3 recouvert avec une couche de dacron 350 gr/m2.

Cale reins: Polyuréthane expansé 25 kg/m3 recouvert avec une couche de dacron 350 gr/m2.

Dossiers appui-tête: Polyuréthane expansé 25 kg/m3 recouvert avec une couche de dacron 350 gr/m2.

Rembourrage de complément: densité 21 kg/m3.

REVETEMENT Cuir ou microfibre non déhoussable. Pour les caractéristiques du revêtement aussi bien que pour l'entretien veuillez consulter les fiches techniques appropriées.

PIEDS En métal couleur chromé ou H 13 cm

NOTE En version relax le modèle est réalisé exclusivement avec relax électrique ayant sa commande située sur la partie latérale extérieure de l'accoudoir, alors que les assises centrales sont équipées avec bouton Touch control placé sur le côté de l'assise. Les éléments avec relax sont toujours séparés des éléments fixes et reliés avec un système à baïonnette. Les versions fixes sans relax sont en tout cas toujours équipées avec mécanique à crémaillère des appui-tête.

VERSIONI CON MECCANISMO RELAX AZIONABILE SOLO ELETTRICAMENTE.

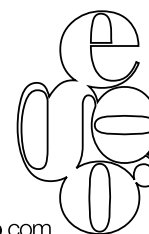

STRUTTURA Realizzata in legno abbinato a particelle di legno grezzo biodegradabile e pannelli di fibra di legno duro.

IMBOTTITURE Cuscini di seduta, braccioli, poggiatesta e schienali reclinabili sono realizzati in poliuretano espanso a densità differenziate ricoperte da un materassino realizzato in piuma d'oca.

Cuscini di seduta: densità 30 kg/mc.

Poggiatesta e poggiatesta : densità 23 kg/mc.

Imbottiture di completamento: densità 21 kg/mc.

Braccioli : densità 30 kg/mc.

RIVESTIMENTO Pelle o microfibra non sfoderabile. Per le caratteristiche del rivestimento e della manutenzione vedere relative schede tecniche.

PIEDI in acciaio finitura cromo o titanio. H cm 14,5

NOTE Gli schienali sono dotati di meccanismo manuale a cricchetto, reclinabili a seconda del comfort desiderato.

FRAME Hard wood combined with plywood and particle board.

PADDING Seat cushion, armrest, kidney rest and inclining headrest in double density polyurethane foam covered with a layer of goose feathers.

Seat cushion: Polyurethane foam 30kg/m3.

Headrest and Kidney rests : Polyurethane foam 23kg/m3.

Armrests : Polyurethane foam 30kg/m3.

Frame padding: 21 kg/m3

COVERING Leather, microfiber or fabric. Not removable. Please check covering details for care instructions.

FEET In metal color chrome or Titanium H 14.5 cm

NOTE The backrests are equipped with manual ratchet mechanism, reclining according to the desired comfort.

STRUCTURE En bois combiné avec du bois non traité et biodégradables et des panneaux de fibres de bois dur.

REMBOURRAGE Coussins d'assise, accoudoirs, cale-reins et dossiers appuie-tête inclinables réalisés en polyuréthane expansé à densité différenciée recouvert d'une couche de plumes d'oie.

Coussins d'assise: Polyuréthane expansé 30 Kg/m3.

Accoudoirs: Polyuréthane expansé 30 Kg/m3.

Appuie-tête et Cale-reins: Polyuréthane expansé 23 Kg/m3

Rembourrage de complément: densité 21 Kg/m3

RETEVEMENT Cuir ou microfibre non déhoussable. Pour les caractéristique du revêtement aussi bien que pour l'entretien veuillez consulter les fiches techniques appropriés.

PIEDS En acier couleur chromé ou Titanium H 14.5

NOTE Les dossiers ont un mécanisme à cliquet manuel, inclinables selon le confort souhaité.

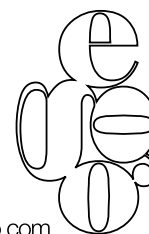
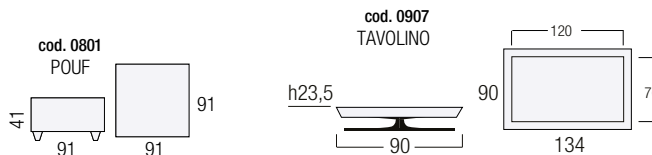
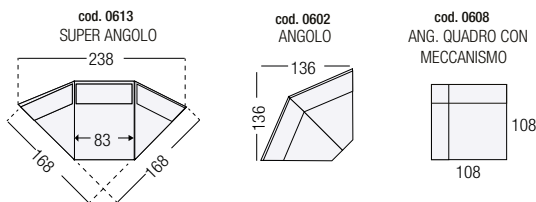
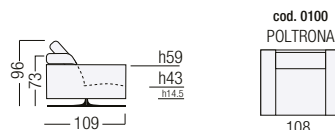
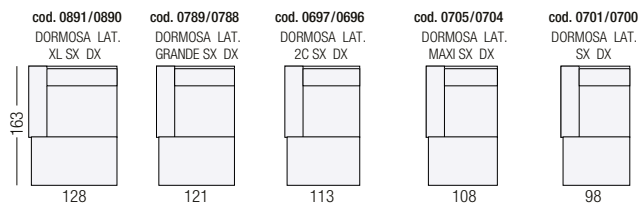
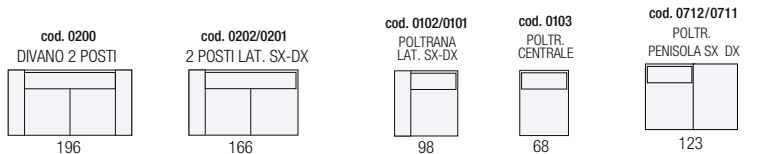
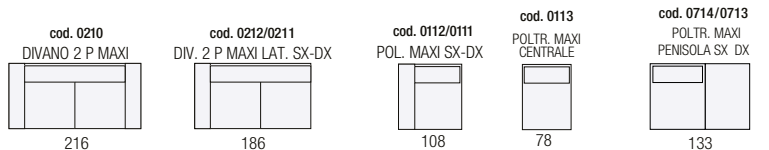
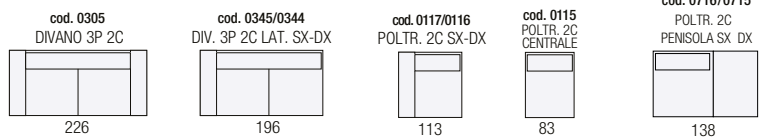
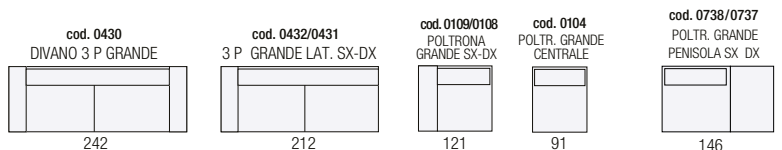
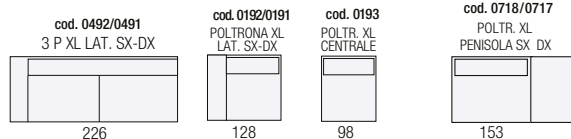

IRON TABLES

STRUTTURA In metallo da mm 4 con finitura in vernici a polvere epossidica, nei colori bianco perla opaco, nero graphite opaco, marrone anticato opaco

FRAME metal feet mm 4 in epoxy powder finish, colour pearl white, black graphite o dark brown.



PLANET COLLECTION

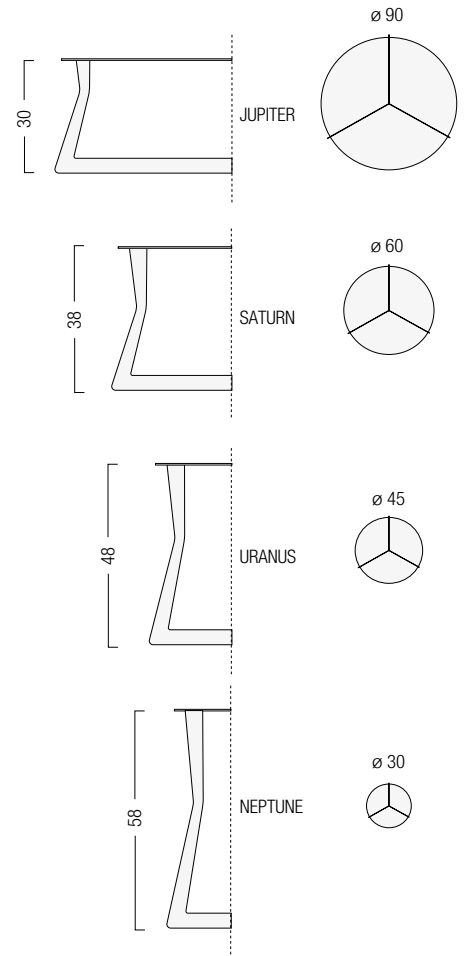

AVAILABLE COLOURS

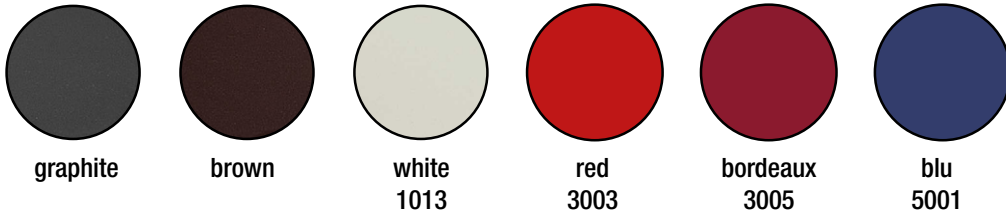

SERVETTI TABLE ARMREST

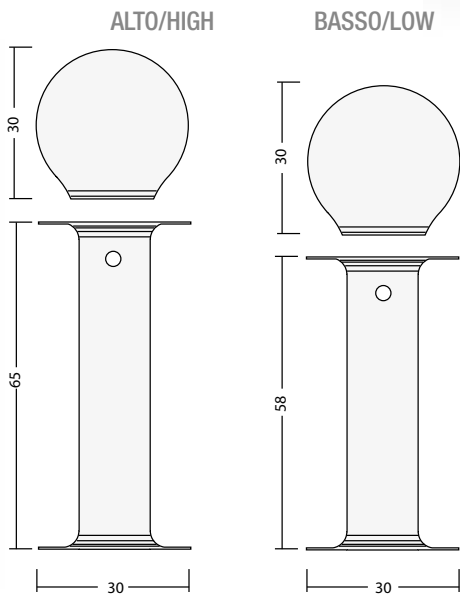
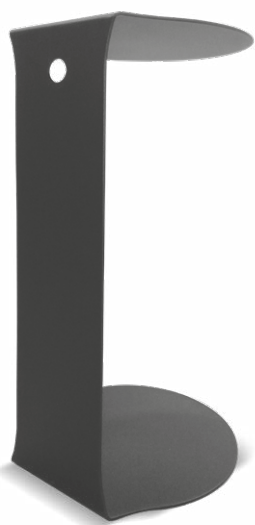

ECLIPSE

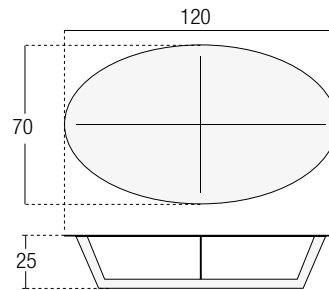

PLECTRUM

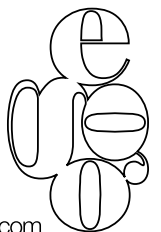
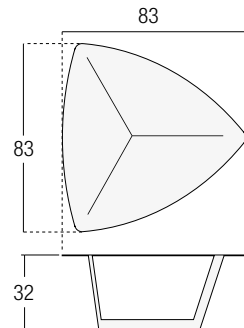

STRUTTURA Realizzata in legno abbinato a particelle di legno grezzo biodegradabile e pannelli di fibra di legno duro.

IMBOTTITURE Cuscini di seduta, braccioli, poggiatesta e spalliere poggiatesta reclinabili sono realizzate in poliuretano espanso. Tutte le parti sopraelencate sono ricoperte da una termofalda di dacron autoestinguente.

Cuscini di seduta a densità differenziata: parte superiore di densità 30 kg/mc soffice, parte inferiore di densità 30 kg/mc portante, ricoperti da una termofalda da 350 gr/mq. Braccioli: densità 30 kg/mc. con completamenti da 21 kg/mc, ricoperti da una falda di dacron resinato da 350 gr/mq.

Poggiatesta: densità 25 kg/mc. Termofalda da 350 gr/mq.

Spalliere poggiatesta: densità 25 kg/mc. Termofalda da 350 gr/mq.

Imbottiture di completamento: densità 21 kg/mc.

RIVESTIMENTO Pelle o microfibra non sfoderabile. Per le caratteristiche del rivestimento e della manutenzione vedere relative schede tecniche.

PIEDI A slitta in metallo, nelle finiture: acciaio lucidato o titanio. H alla base del divano: cm 14,5

NOTE Nella versione relax il modello è dotato esclusivamente di meccanismo elettrico con comando posizionato sul lato esterno del divano, mentre le sedute centrali sono dotate di comandi "touch sensor" posti sul fianco interno della seduta. Gli elementi relax sono sempre staccati da quelli fissi e vengono agganciati con apposito sistema a baionetta. In tutte le versioni, sia fisse che relax, è presente il cricchetto nelle testiere che è regolabile manualmente e permette di creare l'assetto ideale a seconda del tipo di comfort desiderato.

FRAME Hardwood combined with plywood and particle board.

PADDING Seat cushion, armrests, lumbar supports, backrests and headrests are made in polyurethane foam with varying density. All of the above parts are covers with a Dacron layer.

Seat cushions: upper part: 30 kg/m³ "soft comfort". Bottom part: 30 kg/m³ "rigid comfort". Dacron layer 350 gr/m².

Armrest: Polyurethane foam 30 kg/m³ with completion parts in 21 kg/m³ covered in dacron 350 gr/m².

Lumbar support: 25 kg/m³. Dacron layer 350 gr/m².

Backs and headrests: 25 kg/m³. Dacron layer 350 gr/m².

Frame padding: 21 kg/m³

COVERING Leather or microfiber. Not removable. Please check covering details for care instructions.

FEET In metal available in polished steel or titanium. H 14,5 cm.

NOTE when with recliner seats, the model is always equipped electric mechanisms with control panel on the outside part of the armrest. The central seats, when recliner, are equipped with "touch sensor" buttons placed on the seat side. Recliner elements are always detached from fixed elements and can be assembled by means of a bayonet fixing hook.

Headrests are always equipped with manual adjustable mechanism.

STRUCTURE En bois, multiples et particules habillées d'une couche de dacron.

REMBOURRAGE Coussins d'assise, accoudoirs, et dossiers en polyuréthane expansé à double densité. Toutes parties susdites sont recouvertes avec une couche de dacron.

REMBOURRAGE Coussins d'assise, accoudoirs, cales-reins, dossiers et appuie-tête en polyuréthane expansé à double densité. Toutes parties susdites sont recouvertes avec une couche de dacron.

Coussins d'assise : Partie supérieure polyuréthane expansé 30 kg/m³ (souple), partie inférieure polyuréthane expansé 30 kg/m³ portante. Dacron 350 gr/m².

Accoudoirs : Polyuréthane expansé 30 kg/m³ avec rembourrage de complément densité 21 kg/m³ recouvert en dacron 350 gr/m².

Cales-reins : 25 kg/m³. Dacron 350 gr/m².

Dossiers et appuie-tête : 25 kg/m³. Dacron 350/m².

Rembourrage de complément : densité 21 kg/m³.

RETEVEMENT Cuir ou microfibre non déhoussable. Pour les caractéristique du revêtement aussi bien que pour l'entretien veuillez consulter les fiches techniques appropriés.

PIEDS En métal disponible dans les finitions acier poli ou titane, H 14,5 cm.

NOTES Dans les versions relax, les assises sont équipés uniquement avec des moteurs électriques avec commandes situées sur le côté extérieur des accoudoirs, alors que les assises centrales sont équipées avec des boutons « touch sensor » placés sur côté interne de l'assise. Les éléments ave relax sont toujours séparés et peuvent être assemblés entre eux au moyen d'un crochet de fixation à baïonnette.

Toute version est toujours équipée d'un mécanisme de réglage des têtes manuel qui permet de trouver la position de confort souhaité.

VERSIONI CON MECCANISMO RELAX AZIONABILE SOLO ELETTRICAMENTE.

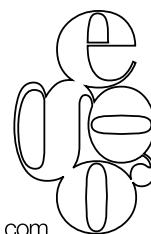
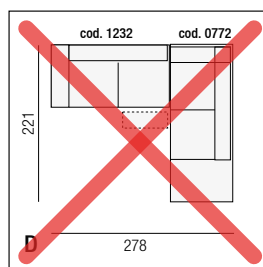
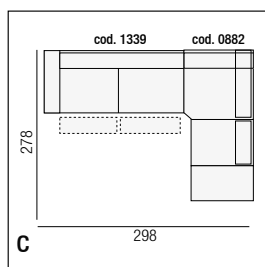
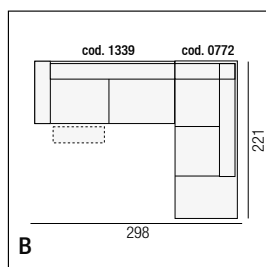
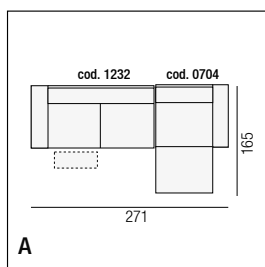
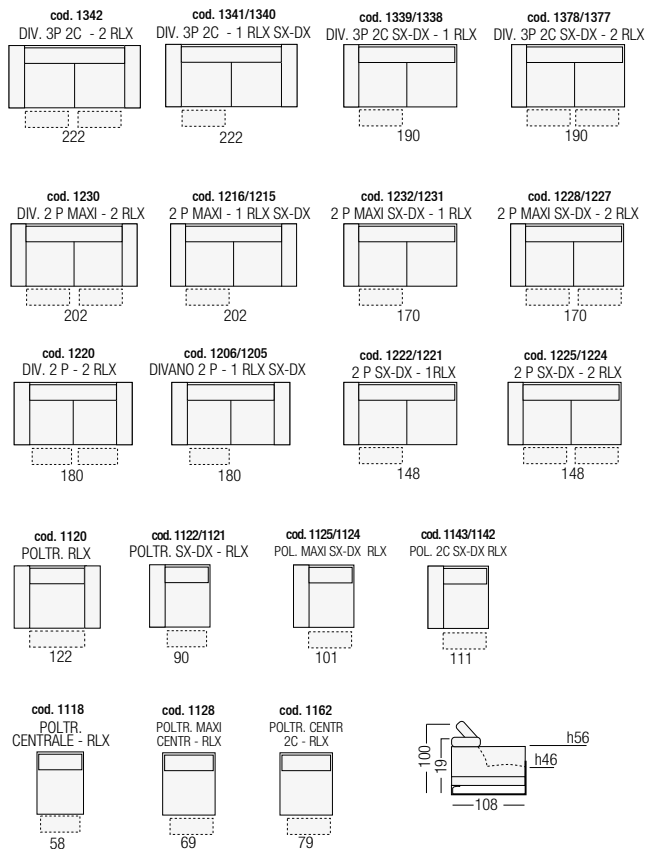
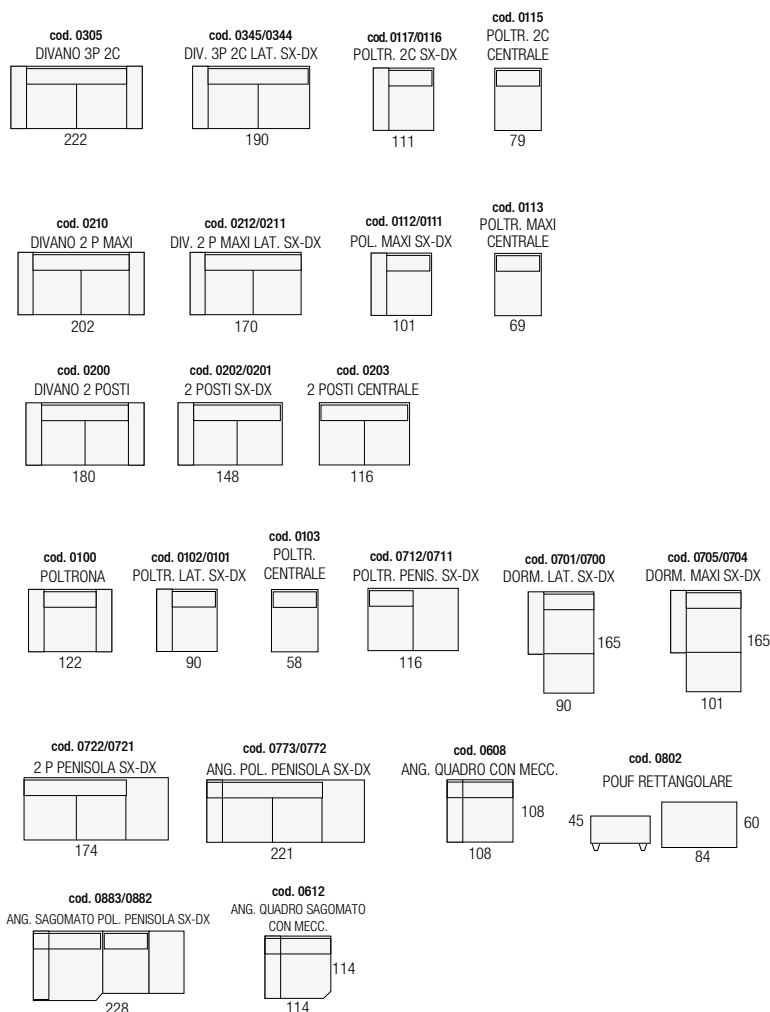

STRUTTURA Realizzata in legno abbinato a particelle di legno grezzo biodegradabile e pannelli di fibra di legno duro.

IMBOTTITURE Cuscino di seduta, braccioli e schienale sono realizzati in poliuretano espanso a densità differenziate. Tutte le parti sopraelencate sono ricoperte da una termofalda di dacron autoestinguente.

Cuscino di seduta: densità 30 kg/mc. ricoperto con una termofalda in dacron resinato da 200 gr/mq.

Braccioli: densità 30 kg/mc. Termofalda da 100 gr/mq.

Schienale: densità 23 kg/mc. Termofalda da 200 gr/mq.

Imbottiture di completamento: densità 21 kg/mc.

RIVESTIMENTO Pelle, tessuto o microfibra. In tessuto o microfibra, su richiesta, il modello è disponibile anche in versione sfoderabile. Si prega di fare riferimento al listino prezzi appropriato. Per le caratteristiche del rivestimento e della manutenzione vedere relative schede tecniche.

PIEDI base circolare girevole in acciaio, disponibile nelle finiture cromo o titanio. H base: cm 12

NOTE Il modello è realizzato con meccanismo combinato con movimento schienale poggiatesta. Tale meccanismo (push-arm) è facilmente azionabile facendo leva sui braccioli e reclinando la seduta nella propria posizione ideale. Kelly è realizzabile esclusivamente con meccanismo manuale.

FRAME Hardwood combined with plywood and particle board.

PADDING Seat cushion, armrests and backrest in polyurethane foam with varying density. All parts are covered with a fire retardant Dacron layer.

Seat cushion: In polyurethane foam 30 kg/m3 covered with a layer of Dacron of 200 gr /sq m.

Armrests: in polyurethane foam 30 kg/m3 covered with a layer of Dacron of 100 gr /sq m.

Backrest: In polyurethane foam 23 kg/m3 covered with a layer of Dacron of 200 gr /sq m.

Frame padding: 21 kg/m3

COVERING Leather, fabric or Microfiber. In fabric or microfiber, upon request, the model is also available with fully removable covers. Please refer to the appropriate price list. Please check covering details for care instructions.

FEET The chair is equipped with a tubular steel circular base, available in chrome or titanium finish. H base: 12 cm.

NOTE The model is equipped with a mechanism allowing the movement of backrest and footrest. This mechanism (push-arm) is easily operated by leveraging on the armrests and reclining the seat in your ideal position. Kelly is only available with manual mechanism.

STRUCTURE En bois, multiples et particules habillée d'une couche de dacron.

REMBOURRAGE Coussin d'assise, accoudoirs et dossiers en polyuréthane expansé. Toutes les son couvertes par une couche de dacron ignifugé.

Assise en polyuréthane expansé densité 30 kg/m3 couvert par une couche de dacron ignifugé de 200 gr/m2.

Accoudoirs en polyuréthane expansé densité 30 kg/m3 couvert par une couche de dacron ignifugé de 100 gr/m2.

Dossiers en polyuréthane expansé densité 23 kg/m3 couvert par une couche de dacron ignifugé de 200 gr/m2.

Rembourrage de complément : densité 21 kg/m3.

REVETEMENT Cuir, tissu ou microfibre. En tissu ou microfibre, sur demande, le modèle est aussi disponible avec revêtement totalement déhoussable. Merci de vous référer au tarif correspondant. Pour les caractéristique du revêtement aussi bien que pour l'entretien veuillez consulter les fiches techniques appropriées.

PIEDS Le fauteuil est équipé avec une base pivotante circulaire en acier, disponible en finition chromé ou titanium. H 12 cm.

NOTE Le modèle est doté d'un mécanisme de mouvement combiné pour dossier et repose-pieds. Ce mécanisme (push-arm) est facilement actionné en appuyant sur les accoudoirs afin d'incliner le siège dans votre emplacement idéal. Kelly est seulement réalisable avec mécanisme manuel.

cod. 0129

POLTRONA GIREVOLE RELAX

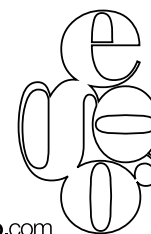
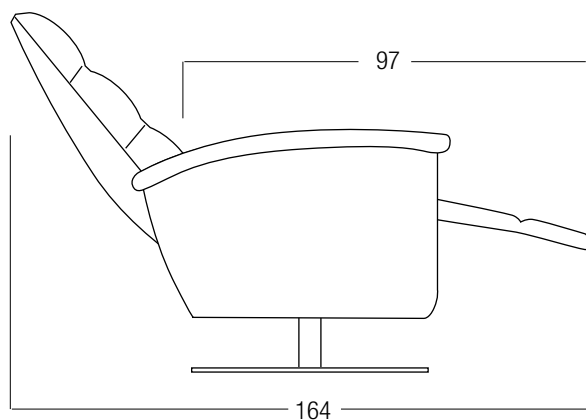
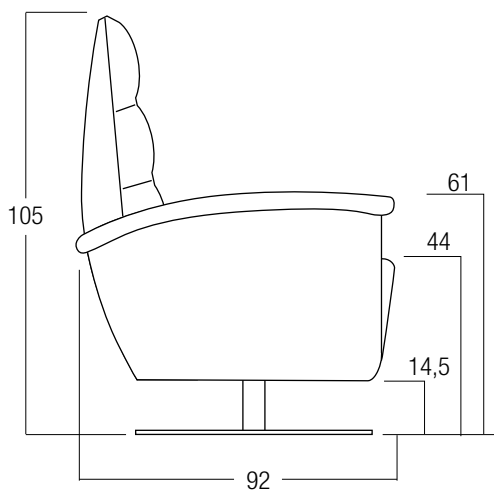
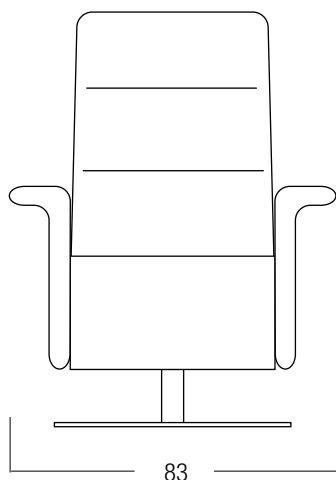

RIVESTIMENTO Pelle o microfibra non sfoderabile. Per le caratteristiche del rivestimento e la manutenzione vedere relative schede tecniche.

IMBOTTITURA Cuscini di seduta e braccioli in poliuretano espanso ecologico a densità differenziata. Cuscini di seduta di densità 30 kg/mc ricoperti con falda di dacron resinato da 100 gr/mq. Cuscini schienali realizzati in fibra di poliestere siliconata in fiocchi. Braccioli di densità 22 Kg/mc ricoperti da una termofalda di dacron autoestingente da 350 gr/mq.

PIEDI In Legno massello di faggio evaporato tinto con vernici ecologiche ad acqua, nei colori: Noce brunito, Wengè. H 4 cm.

STRUTTURA Realizzata in legno abbinato a particelle di legno grezzo biodegradabile e pannelli di fibra di legno duro.

RETE due pieghe elettrosaldati (3 POSTI 150x186), (2 P MAX 120x186).

MATERASSO a molle, optional in poliuretano espanso (3 POSTI 130x180x12), (2 P MAX 100x180x12).

NOTE Le versioni relax presentano un cricchetto manuale nelle testiere, il quale permette di mantenere la testa in posizione diritta (TV position) anche con il meccanismo in posizione di apertura.

COVERING Leather, microfiber or fabric. Not removable.

PADDING Ecologic polyurethane foam.

Seat cushion 30kg/m3 covered with a dacron layer 100gr/m2

Armrest 22kg/m3 covered with dacron layer 350gr/m2

Backrest cushion: siliconed polyester fibre

FEET Beech feet color dark walnut, wengè. H4cm

FRAME Hard wood combined with plywood and particle board covered with a dacron layer.

BASE Electro-welded 2-ply (3 seater 150x186cm, 2 seater maxi 120x186cm)

MATRESS Spring, polyurethane on demand (3 seater 130x180x12cm, 2 seater maxi 100x180x12cm)

NOTE Recliner seats are equipped with an adjustable headrest to reach the « TV position » when the footrest is opened.

REVETEMENT Cuir, microfibre ou tissu non déhoussable.

REMBOURRAGE Coussins d'assise et accoudoirs: polyuréthane écologique à densité différenciée. Coussins d'assise: 30kg/m3 recouverts d'une couche de Dacron résiné 100gr/m2. Dossiers: flocons de mousse. Accoudoirs: densité 22kg/m3 recouverts d'une couche de dacron 350gr/m2.

PIED hêtre massif, vernis écologiques: noyer brun ou Wengè. H 4cm.

STRUCTURE Bois recouvert d'une couche de dacron.

SOMMIER Electro-soudé à 2 plis (3 places 150x186, 2p.max 120x186).

MATELAS À ressorts, sur demande en polyuréthane (3 places 130x180x12, 2p.max 100x180x12).

NOTE Les versions relax sont équipées d'un mécanisme à crémaillère dans la tête pour rejoindre la « position TV » quand le repose-pieds est ouvert.

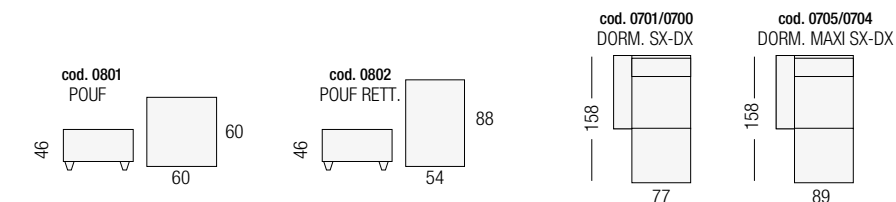
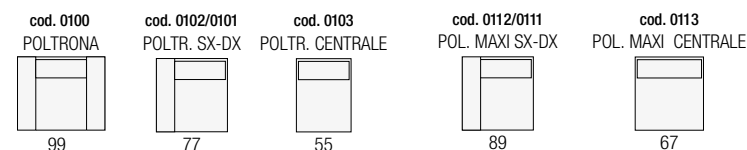
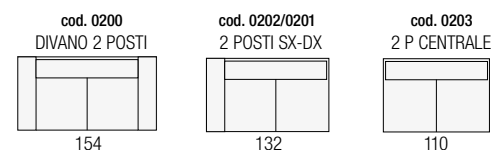
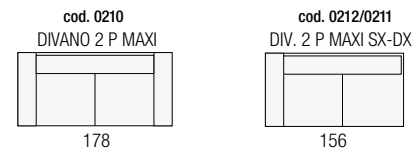
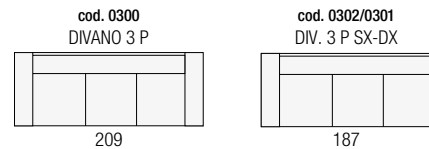
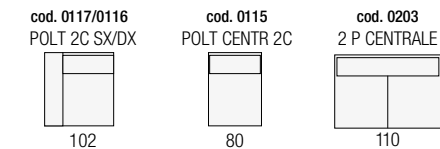
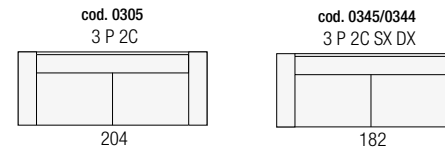

Le versioni relax presentano un cricchetto manuale nelle testiere, il quale permette di mantenere la testa in posizione diritta (TV position) anche con il meccanismo in posizione di apertura.

Les versions relax sont équipées d'un mécanisme à crémaillère dans la tête pour rejoindre la « position TV » quand le repose-pieds est ouvert

Recliner seats are equipped with an adjustable headrest to reach the « TV position » when the footrest is opened

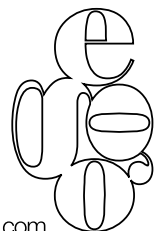
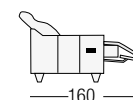
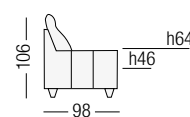
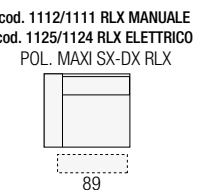
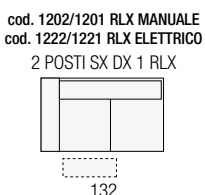
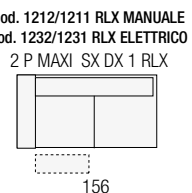
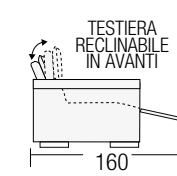
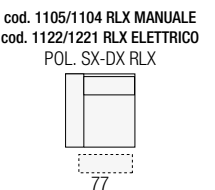
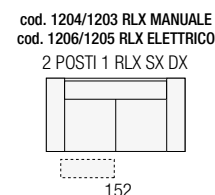
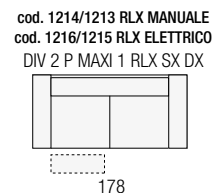
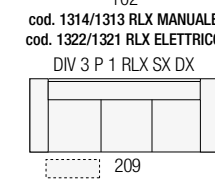
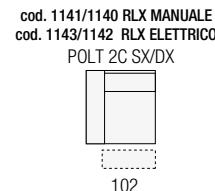
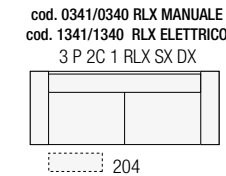
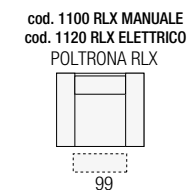
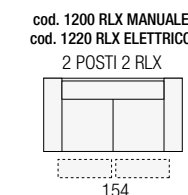
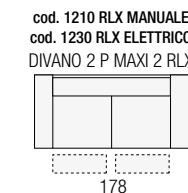
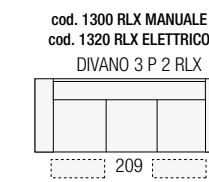
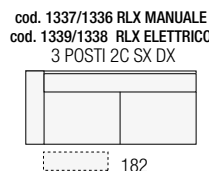
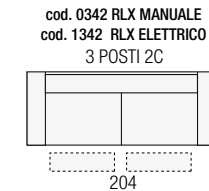

STRUTTURA Realizzata in legno abbinato a particelle di legno grezzo biodegradabile e pannelli di fibra di legno duro.

IMBOTTITURE Cuscini di seduta, braccioli, poggiatesta e spalliere poggiatesta reclinabili sono realizzate in poliuretano espanso a densità differenziate. Tutte le parti sopraelencate sono ricoperte da una termofalda di dacron autoestinguente. Cuscini di seduta: densità 30 kg/mc. falda di dacron da 200 gr/mq. Braccioli: densità 30 kg/mc. Termofalda da 350 gr/mq. Spalliere poggiatesta e poggiatesta: densità 25 kg/mc. Termofalda da 350 gr/mq. Imbottiture di completamento: densità 21 kg/mc.

RIVESTIMENTO Pelle o microfibra non sfoderabile. Per le caratteristiche del rivestimento e della manutenzione vedere relative schede tecniche.

PIEDI In acciaio finitura titanio o nei colori previsti sulle palette disponibili. H alla base del divano: cm 13

NOTE Nella versione relax il modello è dotato esclusivamente di meccanismo elettrico con comando posizionato sul lato esterno del divano, mentre le sedute centrali sono dotate di pulsanti touch control. Gli elementi relax sono sempre staccati da quelli fissi e vengono agganciati con apposito sistema a baionetta. Nelle versioni fisse senza meccanismo relax in ogni caso è presente il cricchetto manuale nelle testiere.

FRAME Hardwood combined with plywood and particle board.

PADDING Seat cushion, armrests, lumbar supports and backrests-headrests are made in polyurethane foam with varying density. Every part mentioned above is covered by a Dacron layer.

Seat cushions: In polyurethane foam 30 kg/m3. Covered by a dacron layer 200 gr/m2. Armrests: Polyurethane foam 30 kg/m3. Dacron layer 350 gr/m2.

Backrests-headrests and lumbar supports: Polyurethane foam 25 kg/m3. Dacron layer 350 gr/m2.

Frame padding: Polyurethane foam 21 kg/m3.

COVERING Leather or microfiber. Not removable. Please check covering details for care instructions.

FEET In metal colour titanium or in the optional colours available in its palette. Height to the base of the sofa 13cm.

NOTE The relax version comes with electric movements only. Controls are placed on the armrest side, whilst armless units are equipped with practical touch sensor buttons placed on the side of the seat cushion itself. Elements with relax mechanism always delivered separately and connected to the fixed parts by made for purpose bayonet fittings. Fixed versions are always equipped with mechanical headrests mechanism.

STRUCTURE En bois, multiples et particules habillés d'une couche de dacron.

REMBOURRAGE Coussins d'assise, accoudoirs, cale reins et dossiers appui-tête en polyuréthane expansé à densité différenciée. Toutes les parties indiquées sont couvertes par une couche de dacron.

Coussins d'assise: en polyuréthane expansé 30 kg/m3. Couche en dacron 200 gr/m2. Accoudoirs: Polyuréthane expansé 30 kg/m3 recouvert avec une couche de dacron 350 gr/m2.

Dossiers appui-tête et cale reins: Polyuréthane expansé 25 kg/m3 recouvert avec une couche de dacron 350 gr/m2.

Rembourrage de complément: densité 21 kg/m3.

RETEMENT Cuir ou microfibre non déhoussable. Pour les caractéristiques du revêtement aussi bien que pour l'entretien veuillez consulter les fiches techniques appropriées.

PIEDS En métal couleur titanium ou dans les finitions prévues dans sa palette. Hauteur à la base du canapé 13 cm

NOTE En version relax le modèle est réalisé exclusivement avec relax électrique ayant sa commande située sur la partie latérale extérieure de l'accoudoir, alors que les assises centrales sont équipées avec bouton Touch control placé sur le côté de l'assise. Les éléments avec relax sont toujours séparés des éléments fixes et reliés avec un système à baïonnette. Les versions fixes sans relax sont en tout cas toujours équipées avec mécanique à crémaillère des appui tête.

VERSIONI CON MECCANISMO RELAX AZIONABILE SOLO ELETTRICAMENTE.

The grid contains the following models and their dimensions (width x height):

- cod. 0430: DIVANO 3 POSTI GRANDE (234 x 117)
- cod. 0432/431: DIV. 3 P GRANDE SX-DX (208 x 117)
- cod. 0109/0108: POLTR. GRANDE SX-DX (117 x 117)
- cod. 0104: POLTR. GRANDE CENTRALE (91 x 117)
- cod. 0305: DIVANO 3P 2C (208 x 117)
- cod. 0345/0344: DIV. 3P 2C LAT. SX-DX (182 x 117)
- cod. 0117/0116: POLTR. 2C SX-DX (104 x 117)
- cod. 0115: POLTR. 2C CENTRALE (78 x 117)
- cod. 0210: DIVANO 2 P MAXI (188 x 117)
- cod. 0212/0211: DIV. 2 P MAXI LAT. SX-DX (162 x 117)
- cod. 0112/0111: POL. MAXI SX-DX (94 x 117)
- cod. 0113: POLTR. MAXI CENTRALE (68 x 117)
- cod. 0103: POLTR. CENTRALE (57 x 117)
- cod. 0200: DIVANO 2 POSTI (166 x 117)
- cod. 0202/0201: 2 POSTI LAT. SX-DX (140 x 117)
- cod. 0203: 2 POSTI CENTRALE (114 x 117)
- cod. 0100: POLTRONA (120 x 117)
- cod. 0102/0101: POLTR. LAT. SX-DX (83 x 117)
- cod. 0176: POLTR. XL (172 x 117)
- cod. 0192/0191: POLTR. XL LAT. SX-DX (146 x 117)
- cod. 0193: POLTR. XL CENTRALE (120 x 117)
- cod. 0771/0770: TERM. TRAPEZIO SX-DX (155 x 126)
- cod. 0701/0700: DORM. LAT. SX-DX (83 x 163)
- cod. 0705/0704: DORM. MAXI SX-DX (94 x 163)
- cod. 0697/0696: DORM. 2C SX-DX (104 x 163)
- cod. 0789/0788: DORM. GRANDE SX-DX (117 x 163)
- cod. 0891/0890: DORM. XL SX-DX (126 x 163)
- cod. 0883/0882: ANG. SAGOMATO POLTR. PEN. SX-DX (107 x 126)
- cod. 0773/0772: ANG. POL. PENISOLA SX-DX (224 x 126)
- cod. 0602: ANGOLO (136 x 136)
- cod. 0608: ANG. QUADRO CON MECC. (115 x 115)
- cod. 0738/0737: POL. GRANDE PENIS. SX-DX (132 x 115)
- cod. 0718/0717: POL. XL PENIS. SX-DX (161 x 115)
- cod. 0716/0715: POL. 2C PENIS. SX-DX (119 x 115)
- cod. 0714/0713: POL. MAXI PENIS. SX-DX (109 x 115)
- cod. 0712/0711: POLTR. PENIS. SX-DX (98 x 115)
- cod. 0802: POUF RETTANGOLARE (80 x 65)
- cod. 0802: POUF RETTANGOLARE (107 x 160)

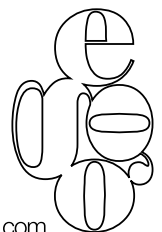

STRUTTURA Realizzata in legno abbinato a particelle di legno grezzo biodegradabile e pannelli di fibra di legno duro.

Struttura della base, portante con funzione di piede, realizzata in legno massello di faggio evaporato con telaio in ferro integrato all'interno.

IMBOTTITURE Cuscini di seduta, braccioli, poggiatesta e spalliere poggiatesta reclinabili sono realizzati in poliuretano espanso a densità differenziate. Tutte le parti sopraelencate sono ricoperte da una termofalda di dacron autoestinguente.

Cuscini di seduta: densità 35 kg/mc. Termofalda da 350 gr/mq.

Braccioli: densità 30 kg/mc. Termofalda da 200 gr/mq.

Spalliere e poggiatesta: densità 25 kg/mc. Termofalda di dacron da 350 gr/mq

Cuscinetto poggiatesta : densità 25 kg/mc. Termofalda da 450 gr/mq.

Imbottiture di completamento: densità 21 kg/mc.

RIVESTIMENTO Pelle o microfibra non sfoderabile. Per le caratteristiche del rivestimento e della manutenzione vedere relative schede tecniche.

PIEDI Base portante con funzione di piede, realizzata in legno massello di faggio evaporato con telaio in ferro integrato ed esclusivamente rivestita in pelle.

H 29,5 cm

NOTE Gli schienali del modello sono dotati di un meccanismo manuale che permette facilmente di spostarli in posizione arretrata ottenendo una maggiore profondità di seduta ed offrendo la possibilità di distendere le gambe per un comfort superiore. Le testiere sono corredate di meccanismi manuali a cricchetto, reclinabili a seconda del comfort desiderato.

FRAME Hardwood combined with plywood and particle board. The base serving as supporting feet is made in beech wood with an integrated metal frame.

PADDING Seat cushions, armrests, lumbar supports and backrests are made in polyurethane foam with varying density. All of the above parts are covered with a Dacron layer.

Seat cushions: In polyurethane foam 35 kg/m3. Dacron layer 350 gr/m2.

Armrests: In polyurethane foam 30 kg/m3. Dacron layer 200 gr/m2.

Backrests and headrests: In polyurethane foam 25 kg/m3. Dacron layer 350 gr/m2.

Lumbar supports: In polyurethane foam 25 kg/m3. Dacron layer 450 gr/m2.

Frame padding: 21 kg/m3

COVERING Leather or microfiber. Not removable. Please check covering details for care instructions.

FEET base serving as supporting feet in beech wood with an integrated metal frame totally covered in leather. H 29.5 cm

NOTE The backrests of the model are equipped with a manual mechanism which makes it possible to easily vary the depth of the seating to gain more place for a greater comfort.

The headrests are equipped with manual ratchet mechanism, tilting according to the desired comfort.

STRUCTURE En bois, multiples et particules habillés d'une couche de dacron. La structure de la base portante ayant fonction de piétement, est réalisée en bois de hêtre et cadre en fer intégré à son intérieur.

REMBOURRAGE Coussins d'assise, accoudoirs, cales reins et dossiers en polyuréthane expansé à double densité. Toutes parties susdites sont recouvertes avec une couche de dacron.

Coussins d'assise: En polyuréthane expansé 35 kg/m3. Dacron 350 gr/m2.

Accoudoirs: En polyuréthane expansé 30 kg/m3. Dacron 200 gr/m2.

Dossiers et têtes: En polyuréthane expansé 25 kg/m3 habillé avec une couche de dacron 350 gr/m2.

Coussin cales reins: En polyuréthane expansé 25 kg/m3 habillé avec une couche de dacron 450 gr/m2.

Rembourrage de complément : densité 21 kg/m3.

REVETEMENT Cuir ou microfibra non déhoussable. Pour les caractéristique du revêtement aussi bien que pour l'entretien veuillez consulter les fiches techniques appropriés.

PIEDS Base portante ayant fonction de piétement en bois de hêtre et cadre en fer intégré, totalement habillé en cuir. H 29.5 cm

NOTES Les dossiers du modèle sont équipés d'un mécanisme manuel qui permet de varier facilement la profondeur de la place assise pour un plus grand confort.

Les têtes sont équipées de mécanique manuelles à crémaillère, inclinable selon le confort souhaité.

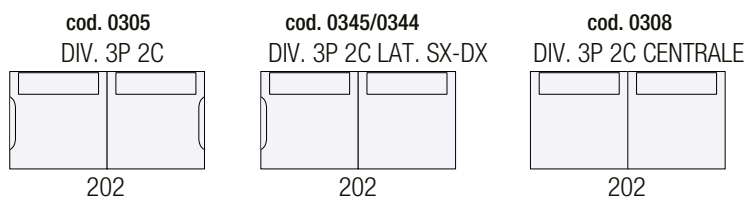

cod. 0100
POLTRONA

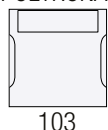

cod. 0102/0101
POL. LAT. SX-DX

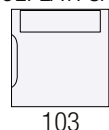

cod. 0103
POL. CENTRALE

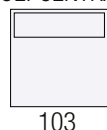

cod. 0801
POUF

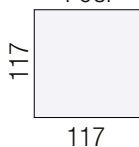

cod. 0851
POUF
TAVOLINO

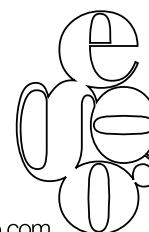
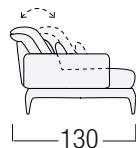
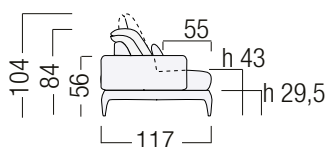
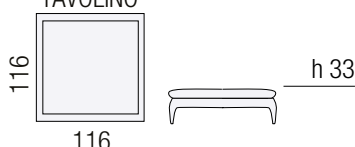

STRUTTURA Realizzata in legno abbinato a particelle di legno grezzo biodegradabile e pannelli di fibra di legno duro.

IMBOTTITURE Cuscini di seduta, braccioli, poggiatesta e spalliere poggiatesta reclinabili sono realizzate in poliuretano espanso a densità differenziate. Tutte le parti sopraelencate sono ricoperte da una termofalda di dacron autoestinguente. Cuscini di seduta: densità 35 kg/mc. Termofalda di dacron da 350 gr/mq.

Braccioli: densità 30 kg/mc. Termofalda da 200 gr/mq.

Spalliere poggiatesta e poggiatesta: densità 25 kg/mc. Termofalda da 350 gr/mq. Imbottiture di completamento: densità 21 kg/mc.

RIVESTIMENTO Pelle o microfibra non sfoderabile. Per le caratteristiche del rivestimento e della manutenzione vedere relative schede tecniche.

PIEDI In acciaio finitura titanio o nei colori previsti sulle palette disponibili. H alla base del divano: cm 12

NOTE Nella versione relax il modello è dotato esclusivamente di meccanismo elettrico con comando posizionato sul lato interno delle sedute. Gli elementi relax sono sempre staccati da quelli fissi e vengono agganciati con apposito sistema a baionetta. Nelle versioni fisse senza meccanismo relax in ogni caso è presente il cricchetto manuale nelle testiere.

FRAME Hardwood combined with plywood and particle board.

PADDING Seat cushion, armrests, lumbar supports and backrests-headrests are made in polyurethane foam with varying density. Every part mentioned above is covered by a Dacron layer.

Seat cushions: In polyurethane foam 35 kg/m3. Covered by a dacron layer 350 gr/m2.

Armrests: Polyurethane foam 30 kg/m3. Dacron layer 200 gr/m2.

Backrests-headrests and lumbar supports: Polyurethane foam 25 kg/m3. Dacron layer 350 gr/m2.

Frame padding: Polyurethane foam 21 kg/m3.

COVERING Leather or microfiber. Not removable. Please check covering details for care instructions.

FEET In metal colour titanium or in the optional colours available in its palette. Height to the base of the sofa 12cm.

NOTE The relax version comes with electric movements only. Controls are placed on the seat side. Elements with relax mechanism always delivered separately and connected to the fixed parts by made for purpose bayonet fittings. Fixed versions are always equipped with mechanical headrests mechanism.

STRUCTURE En bois, multiplies et particules habillés d'une couche de dacron.

REMBOURRAGE Coussins d'assise, accoudoirs, cale reins et dossiers appui-tête en polyuréthane expansé à densité différenciée. Toutes les parties indiquées sont couvertes par une couche de dacron.

Coussins d'assise: en polyuréthane expansé 35 kg/m3. Couche en dacron 350 gr/m2.

Accoudoirs: Polyuréthane expansé 30 kg/m3 recouvert avec une couche de dacron 200 gr/m2.

Dossiers appui-tête et cale reins: Polyuréthane expansé 25 kg/m3 recouvert avec une couche de dacron 350 gr/m2.

Rembourrage de complément: densité 21 kg/m3.

REVETEMENT Cuir ou microfibre non déhoussable. Pour les caractéristiques du revêtement aussi bien que pour l'entretien veuillez consulter les fiches techniques appropriées.

PIEDS En métal couleur titanium ou dans les finitions prévues dans sa palette. Hauteur à la base du canapé 12 cm

NOTE En version relax le modèle est réalisé exclusivement avec relax électrique ayant sa commande située sur la partie latérale interne des assises. Les éléments avec relax sont toujours séparés des éléments fixes et reliés avec un système à baïonnette. Les versions fixes sans relax sont en tout cas toujours équipées avec mécanique à crémaillère des appui tête.

VERSIONI CON MECCANISMO RELAX AZIONABILE SOLO ELETTRICAMENTE.

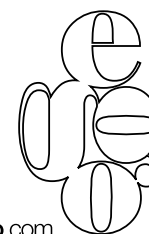
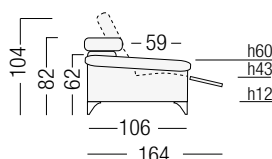
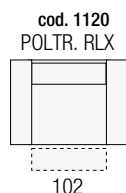
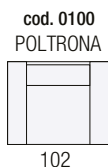
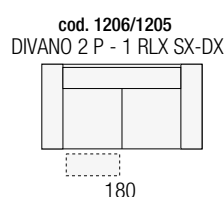
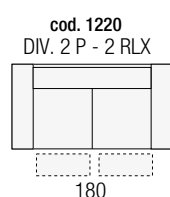
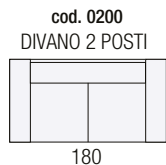
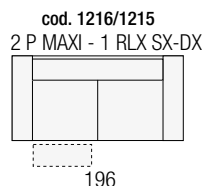
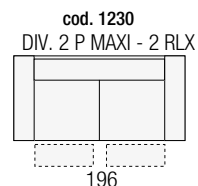
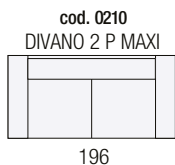
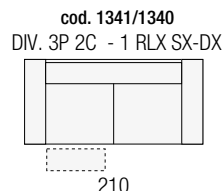
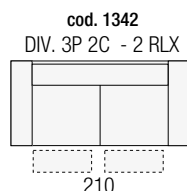
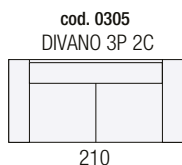
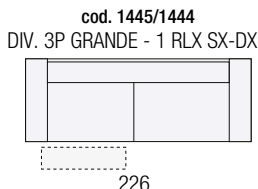
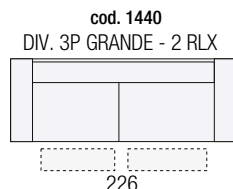
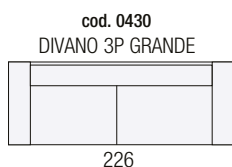

STRUTTURA Realizzata in legno abbinato a particelle di legno grezzo biodegradabile e pannelli di fibra di legno duro.

IMBOTTITURE Cuscini di seduta, braccioli e schienali sono realizzati in poliuretano espanso a densità differenziate, ricoperti da una termofalda di dacron autoestinguente.

Cuscini di seduta: estremità anteriore e posteriore: densità 35 kg/mc. Parte centrale: densità 30 kg/mc. Termofalda da 350 gr/mq.

Spalliere: densità 25 kg/mc, ricoperte sui fianchi con dacron resinato da 200 gr/mq ed avvolte in una termofalda di dacron da 350 gr/mq

Poggiareni: densità 25 kg/mc. Termofalda da 350 gr/mq.

Imbottiture di completamento: densità 21 kg/mc.

RIVESTIMENTO Pelle o microfibra non sfoderabile. Per le caratteristiche del rivestimento e della manutenzione vedere relative schede tecniche.

PIEDI in legno massello di faggio evaporato H cm 16, rivestiti in cuoietto nei seguenti colori: 0001B nero / C130N testa di moro / I152N cuoio / F135N tortora.

NOTE Il modello è concepito con elementi modulari assemblabili tra di loro con facilità, tramite agganci a scomparsa posizionati lateralmente sotto ogni modulo. Gli schienali sono dotati di una meccanica manuale "a bilanciere" che permette di spostare gli stessi in maniera tale da rendere bifacciale l'elemento di seduta.

FRAME Hardwood combined with plywood and particle board.

PADDING Seat cushion, armrests and backrests are made in polyurethane foam with varying density. All of the above parts are covered with a Dacron layer.

Seat cushions: Front and back part in polyurethane foam 35 kg/m3. Central part in polyurethane foam 30 kg/mc. Dacron layer 350 gr/m2.

Backrests: In polyurethane foam 25 kg/m3 covered on the sides by a dacron layer 200 gr/m2 and subsequently wrapped with a 350 gr/m2 dacron layer.

Frame padding: 21 kg/m3

COVERING Leather or microfiber. Not removable. Please check covering details for care instructions.

FEET In wood H 16 cm, covered in leather in the following colours:

0001B black / C130N dark brown / I152N cuoio / F135N tortora

NOTE The model is made by modular elements that can be assembled between them with ease, by means of hooks placed laterally under each module. The backrests are equipped with a manual "rocker" mechanism that allows you to move their position so that you can change the seating direction, thus making a double-sided sofa.

STRUCTURE En bois, multiples et particules habillés d'une couche de dacron.

REMBOURRAGE Coussins d'assise, accoudoirs, et dossiers en polyuréthane expansé à double densité. Toutes parties susdites sont recouvertes avec une couche de dacron.

Coussins d'assise: Partie antérieure et postérieure en polyuréthane expansé 35 kg/m3. Partie centrale densité 30 kg/m3. Dacron 350 gr/m2.

Dossiers: en polyuréthane expansé 25 kg/m3 couvert sur le cotés avec du dacron 200 gr/m2 et habillé avec couche de dacron 350 gr/m2.

Rembourrage de complément: densité 21 kg/m3.

RETEVEMENT Cuir ou microfibre non déhoussable. Pour les caractéristique du revêtement aussi bien que pour l'entretien veuillez consulter les fiches techniques appropriés.

PIEDS En bois, H 16 cm habillé avec cuir/cuoietto dans les couleurs suivants: 0001B noir / C130N tête de nègre / I152N cuoio / F135N tortora

NOTES Le modèle est conçu avec des éléments modulaires qui peuvent être assemblés entre eux avec facilité, au moyen de crochets placés latéralement en dessous de chaque module. Les dossiers sont équipés d'une mécanique «à bascule» qui permet de les déplacer tout en réalisant un modèle avec direction d'assise double face.

cod. 0104
POLTR. GRANDE
CENTRALE



92

cod. 0223
2 POSTI CENTRALE
GRANDE



184

cod. 0103
POLTRONA
CENTRALE

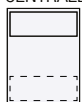

72

cod. 0203
2 POSTI CENTRALE

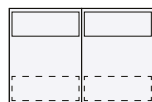

144

cod. 0682
DORMOSA

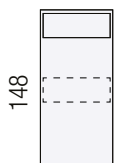

148

72

cod. 0683
DORMOSA
GRANDE

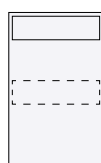

92

cod. 0820
POUF QUADRATO
GRANDE



92

92

cod. 0801
POUF QUADRATO

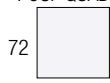

72

72

cod. 0851
POUF
TAVOLINO



91

91

25

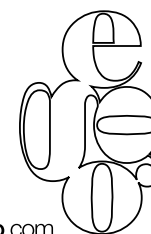
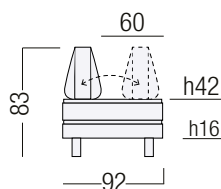

STRUTTURA Realizzata in legno abbinato a particelle di legno grezzo biodegradabile e pannelli di fibra di legno duro.

IMBOTTITURE Cuscini di seduta, braccioli, poggiatesta reclinabili sono realizzate in poliuretano espanso a densità differenziate. Tutte le parti sopraelencate sono ricoperte da una termofalda di dacron autoestinguente. Cuscini di seduta: densità 30 kg/mc con parte anteriore di densità 35 kg/mc. Termofalda da 350 gr/mq.

Braccioli: densità 30 kg/mc. Termofalda da 350 gr/mq.

Poggiatesta e poggiatesta: densità 23 kg/mc. Termofalda da 350 gr/mq.

Imbottiture di completamento: densità 21 kg/mc.

RIVESTIMENTO Pelle o microfibra non sfoderabile. Per le caratteristiche del rivestimento e della manutenzione vedere relative schede tecniche.

PIEDI In acciaio verniciato nei colori previsti sulle palette disponibili oppure in legno massello di faggio evaporato, tinto con vernici ecologiche ad acqua, color noce toffee. H alla base del divano: cm 13

NOTE Nella versione relax il modello è dotato esclusivamente di meccanismo elettrico con comandi touch sensor posizionati nello spazio interno tra seduta e bracciolo. Anche sulle sedute centrali i tasti touch sensor sono posizionati sul fianco interno della seduta. Gli elementi relax sono sempre staccati da quelli fissi e vengono agganciati con apposito sistema a baionetta. Nelle versioni fisse senza meccanismo relax in ogni caso è presente il cricchetto manuale nelle testiere.

FRAME Hard wood combined with plywood and particle board covered with a Dacron layer.

PADDING Seat cushion, armrest, kidney rest and headrest: double density polyurethane foam covered with a Dacron layer.

Seat cushion: polyurethane foam 30kg/m3 and front part in 35 kg/m3. Dacron layer 350 gr/m2

Armrests : polyurethane foam 30kg/m3. Dacron layer 350 gr/m2

Headrests and Kidney rests : polyurethane foam 23 kg/m3. Dacron layer 350 gr/m2.

Frame padding: 21 kg/m3

COVERING Leather, microfiber or fabric. Not removable. Please check covering details for care instructions.

FEET In metal varnished in the available colour palette or in wooden coloured with ecologic finishes, toffee walnut. Height to the base of the sofa 13 cm.

NOTE In the relax version the model is equipped exclusively with electrical mechanism having its touch button controls positioned between the seat side and the armrest. Also on the armless units the touch button controls are positioned on the seats sides. The relax elements are always separated from the fixed ones and are hooked together with an appropriate bayonet system. Fixed versions without relax mechanism are always equipped with adjustable manual headrests.

STRUCTURE En bois massif, multiplis et particules habillées d'une couche de dacron.

REMBOURRAGE Coussins d'assise, cales reins, accoudoirs et dossiers/appuie-tête réclinables réalisés en polyuréthane expansé écologique à double densité recouvert avec une couche de dacron.

Coussins d'assise: En polyuréthane expansé 30 Kg/m3. Partie frontale: 35 Kg/m3. Recouvert d'une couche de Dacron 350gr/m2

Accoudoirs: : En polyuréthane expansé 30 Kg/m3. Dacron 350 gr/m2

Cale-reins et Appuie-tête: En polyuréthane expansé 23Kg/m3. Dacron 350 gr/m2

Rembourrage de complément: densità 21 Kg/m3

REVETEMENT Cuir ou microfibre non déhoussable. Pour les caractéristique du revêtement aussi bien que pour l'entretien veuillez consulter les fiches techniques appropriés.

PIEDS En metal disponible dans les couleurs en applette ou bien en bois massif teinté avec vernis écologiques noyer toffee. Hauteur à l'abese du canapé 13 cm.

NOTE Dans les versions avec relax le modèle est équipé exclusivement d'un mécanisme électrique ayant son contrôle touch sensor (touche tactile) placé sur le côté interne entre accoudoir et assise. Les éléments batards sont aussi équipés de contrôle touch sensor (touche tactile) insérés sur le côté des assises. Les éléments avec relax sont toujours séparés de ceux fixes et sont accrochés avec le système à baïonnette appropriée. Dans la version fixe sans mécanisme de relaxation les têtes sont en tout cas équipées avec mécanique manuelle.

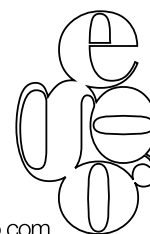
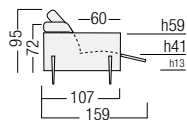
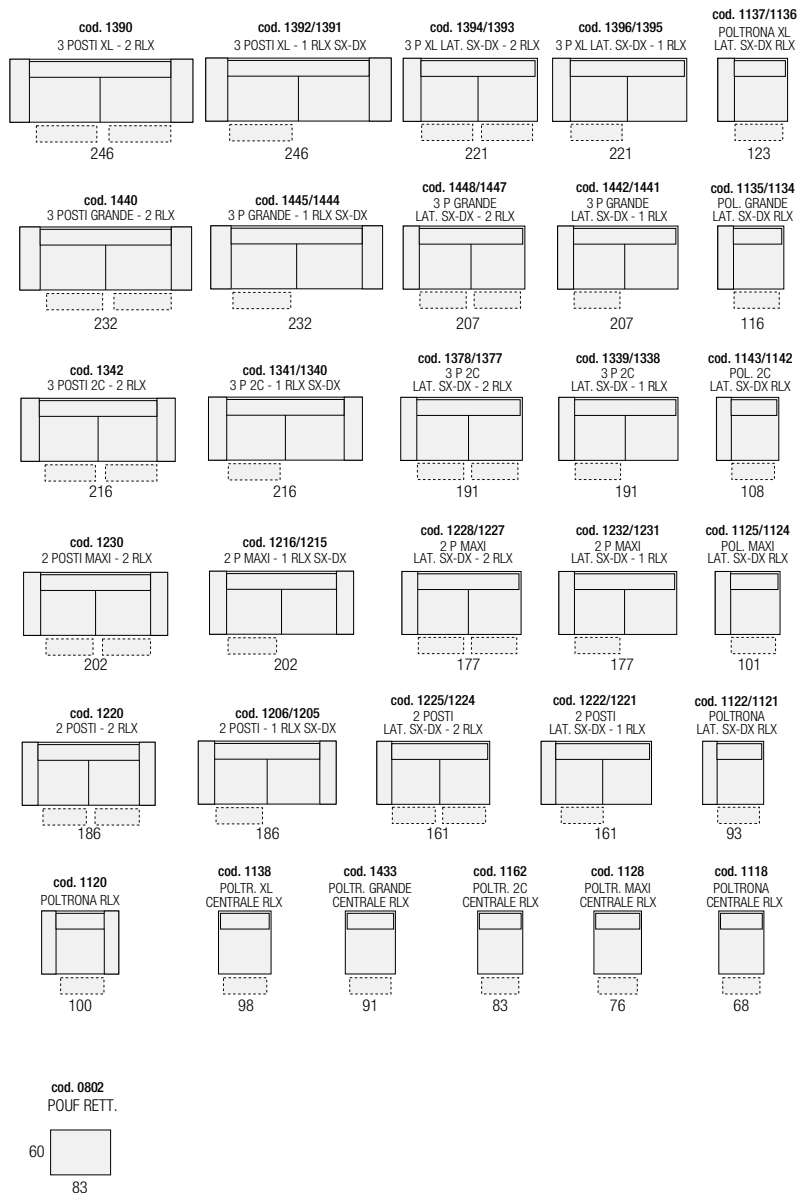
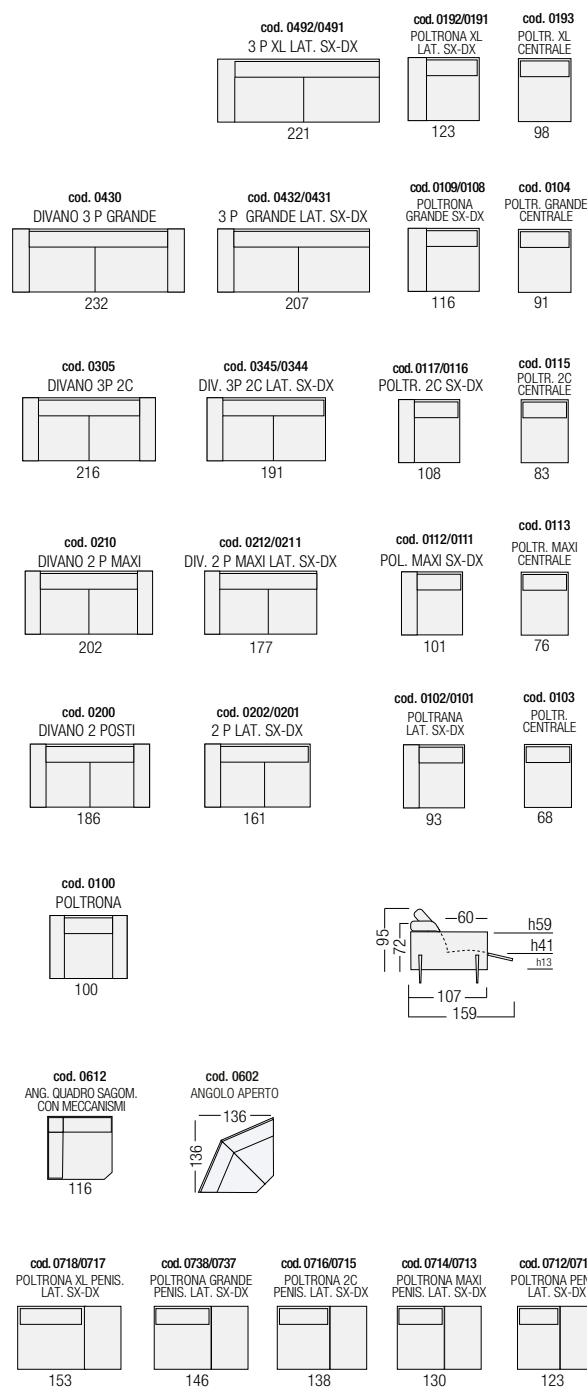

STRUTTURA Realizzata in legno abbinato a particelle di legno grezzo biodegradabile e pannelli di fibra di legno duro.

IMBOTTITURE Cuscini di seduta e poggiatesta sono realizzati in poliuretano espanso a densità differenziate, ricoperti da un materassino realizzato in piuma d'oca. Schienali e braccioli sono realizzati in poliuretano espanso a densità differenziate, ricoperti da una termofalda di dacron autoestinguente.

Cuscini di seduta: densità 30 kg/mc. Con parte anteriore di densità 35 kg/mc. Copertura con materassino in piuma. Braccioli: densità 40 kg/mc. Termofalda da 200 gr/mq. Schienali: parte anteriore di densità 23 kg/mc, parte posteriore di densità 40 kg/mc. ricoperti con termofalda in doppio strato: inferiore da 200 gr/mq, superiore da 350 gr/mq. Poggiatesta: parte anteriore di densità 23kg/mc, parte posteriore densità 40 kg/mc. Copertura con materassino in piuma. Imbottiture di completamento: densità 21 kg/mc.

RIVESTIMENTO Pelle, tessuto o microfibra. In tessuto, su richiesta, il modello è disponibile anche in versione sfoderabile. Si prega di fare riferimento al listino prezzi appropriato. Per le caratteristiche del rivestimento e della manutenzione vedere relative schede tecniche.

PIEDI in ABS da cm 4

NOTE Il modello, sia nelle versioni relax che in quelle fisse, è dotato di schienali ad altezza variabile sino ad un massimo di cm 18, regolabili tramite motori elettrici posti all'interno del divano. I motori sono azionabili con semplici ed intuitivi pulsanti posti sui lati interni delle sedute. Nelle versioni relax, con sedute dotate esclusivamente di motori elettrici, accanto ai pulsanti che agiscono sugli schienali, vi sono quelli che comandano la regolazione di apertura/chiusura della seduta. Il movimento delle sedute è indipendente da quello degli schienali. Sedute e schienali motorizzati, con la loro azione combinata possono assecondare qualsiasi esigenza di comfort. Tutti gli elementi, sia fissi che con meccanismo relax sono modulari ed assemblabili tra di loro per mezzo di appositi agganci a baionetta.

FRAME Hardwood combined with plywood and particle board.

PADDING Seat cushions and lumbar supports are made in polyurethane foam with varying density, covered with a layer of duck feathers. Backrests and armrests are made in polyurethane foam with varying density covered with a Dacron layer. Seat cushions: Polyurethane foam 30 kg/m3 with front part in polyurethane foam density 35 kg/m3. Duck feathers layer.

Armrests: Polyurethane foam 40 kg/m3. Dacron layer 200 gr/m2. Backrests: front part in polyurethane foam density 23 kg/m3 and back part in polyurethane foam density 40 kg/m3 covered by a double Dacron layer: bottom part 200 gr/m2 and top part 350 gr/m2.

Lumbar supports: front part in polyurethane foam density 23 kg/m3 and back part in polyurethane foam density 40 kg/m3 covered by a duck feathers layer. Frame padding: 21 kg/m3

COVERING Leather, fabric or Microfiber. In fabric, upon request, the model is also available with fully removable covers. Please refer to the appropriate price list. Please check covering details for care instructions.

FEET In black ABS 4 cm.

NOTE The model is always equipped with variable height backrests up to a maximum of 18 cm, adjustable by electric motors located inside the sofa. The engines can be operated with simple and intuitive buttons located on the inner sides of the seats.

Relax versions have seats fitted with electric motors only, and its controls are placed next to the buttons that act on the backrests. The seats movement is independent of that of the backrests. Motorized seats and backs, with their combined action can satisfy any need of comfort.

All the elements, both fixed and with relax mechanism, are modular and can be assembled by means of a bayonet fixing hook.

STRUCTURE En bois, multiples et particules habillés d'une couche de dacron.

REMBOURRAGE Coussins d'assise et cales-reins en polyuréthane expansé à double densité couvert par une couche de plumes d'oie. Dossiers et accoudoirs en polyuréthane expansé à double densité. Toutes parties susdites sont recouvertes avec une couche de dacron. Coussins d'assise: Polyuréthane expansé 30 kg/m3 avec partie antérieure 35 kg/m3. Couche en plumes d'oie. Accoudoirs: Polyuréthane expansé 40 kg/m3. Dacron 200 gr/m2. Dossiers: Partie antérieure en polyuréthane expansé 23 kg/m3 avec partie postérieure 40 kg/m3 recouvert par une double couche de dacron : inférieure 200 gr/mq, supérieure 350 gr/mq. Cales-reins: Partie antérieure en polyuréthane expansé 23 kg/m3 et partie postérieure 40 kg/m3 recouvert par une couche en plumes d'oie. Rembourrage de complément: densité 21 kg/m3.

REVÊTEMENT Cuir, tissu ou microfibre. En tissu, sur demande, le modèle est aussi disponible avec revêtement totalement déhoussable. Merci de vous référer au tarif correspondant. Pour les caractéristique du revêtement aussi bien que pour l'entretien veuillez consulter les fiches techniques appropriées.

PIEDS En ABS de 4 cm.

NOTES Le modèle, en version relax ou en version fixe, est équipé de dossiers ayant une hauteur variable jusqu'à un maximum de 18 cm, réglable par des moteurs électriques situés à l'intérieur du canapé. Les moteurs peuvent être actionnés par des boutons simples et intuitifs situés sur les côtés intérieurs des assises.

Dans les versions relax, les assises sont équipés uniquement avec des moteurs électriques, à côté des boutons qui agissent sur les dossiers, il ya ceux qui contrôlent le réglage de l'ouverture / fermeture de l'assise. Le mouvement des assises est indépendant de celui des dossiers. Assises et dossiers motorisés, avec leur action combinée peuvent satisfaire toutes les exigences de confort.

Tous les éléments, à la fois fixe et avec un mécanisme de relaxation sont modulaires et peuvent être assemblés entre eux au moyen d'un crochet de fixation à baïonnette.

N.B. LE SEDUTE SENZA MOTORE RELAX DEVONO ESSERE COMUNQUE DOTATE DI MOTORE LIFT

cod. 0324 DIVANO 3P XL LIFT 272	cod. 0326/0325 DIV. 3P XL LIFT SX-DX 246	cod. 0139/0138 POLTR. XL LIFT SX-DX 136	cod. 0175 POLTR. XL LIFT CENTRALE 110	cod. 0798/0799 POLTR. XL LIFT PENIS. SX-DX 165	cod. 0687/0686 DORM. XL LIFT SX-DX 160 136
cod. 0327 DIV. 3P GRANDE LIFT 234	cod. 0329/0328 DIV. 3P GRANDE LIFT SX-DX 208	cod. 0173/0172 POLTR. GRANDE LIFT SX-DX 117	cod. 0174 POLTR. GRANDE LIFT CENTRALE 91	cod. 0797/0796 POLTR. GRANDE LIFT PENIS. SX-DX 146	cod. 0630 ANG. QUADRO LIFT 110 110
cod. 0330 DIVANO 3P 2C LIFT 216	cod. 0332/0331 DIV. 3P 2C LIFT LAT. SX-DX 190	cod. 0148/0147 POLTR. 2C LIFT SX-DX 108	cod. 0149 POLTR. 2C LIFT CENTRALE 82	cod. 0795/0794 POLTR. 2C LIFT PENIS. SX-DX 137	cod. 0604 ANG. QUADRO 110 110
cod. 0240 DIVANO 2 P MAXI LIFT 202	cod. 0242/0241 2 P MAXI LIFT LAT. SX-DX 176	cod. 0145/0144 POL. MAXI LIFT SX-DX 101	cod. 0146 POLTR. MAXI LIFT CENTRALE 75	cod. 0793/0792 POLTR. MAXI LIFT PENIS. SX-DX 130	cod. 0602 ANGOLO 130 130
cod. 0230 DIVANO 2 POSTI LIFT 180	cod. 0232/0231 2 POSTI LIFT SX-DX 154	cod. 0142/0141 POL. LIFT SX-DX 90	cod. 0143 POLTRONA LIFT CENTRALE 64	cod. 0791/0790 POLTR. LIFT PENIS. SX-DX 119	cod. 0691/0690 DORM. MAXI LIFT SX-DX 160 101
2 Motori - cod. 1397 DIVANO 3P XL - 2 RLX 272	2 Motori - cod. 1399/1398 DIVANO 3P XL - 1 RLX SX-DX 272	2 Motori - cod. 1325/1324 DIVANO 3P XL - 2 RLX SX-DX 246	2 Motori - cod. 1327/1326 DIVANO 3P XL - 1 RLX SX-DX 246	2 Motori - cod. 1150/1149 POLTR. XL RLX SX-DX 136	2 M-cod. 1166 POLTRONA RLX CENTRALE 110
2 Motori - cod. 1383 DIV. 3P GRANDE 2 RLX 234	2 Motori - cod. 1385/1384 DIV. 3P GRANDE 1 RLX SX-DX 234	2 Motori - cod. 1387/1386 3P GRANDE 2 RLX SX-DX 208	2 Motori - cod. 1389/1388 DIV. 3P GRANDE 1RLX SX-DX 208	2 M-cod. 1164/1163 POLTR. GRANDE RLX SX-DX 117	2 M-cod. 1165 POLTR. GRANDE RLX CENTRALE 91
2 Motori - cod. 1317 DIVANO 3P 2C 2 RLX 216	2 Motori - cod. 1374/1373 DIV. 3P 2C 1 RLX SX-DX 216	2 Motori - cod. 1357/1356 3P 2C 2 RLX SX-DX 190	2 Motori - cod. 1335/1334 3P 2C 1 RLX SX-DX 190	2 M-cod. 1155/1154 POLTR. 2C RLX SX-DX 108	2 M-cod. 1153 POLTR. 2C RLX CENTRALE 82
2 Motori - cod. 1239 DIVANO 2 P MAXI 2RLX 202	2 Motori - cod. 1218/1217 DIVANO 2 P MAXI 1 RLX 202	2 P-cod. 1241/1240 2 P MAXI 2RLX SX-DX 176	2 Motori - cod. 1246/1245 2 P MAXI 1 RLX SX-DX 176	2 M-cod. 1158/1157 POL. MAXI RLX SX-DX 101	2 M-cod. 1156 POLTR. MAXI RLX CENTRALE 75
2 Motori - cod. 1244 DIVANO 2 POSTI 2RLX 180	2 Motori - cod. 1236/1235 DIVANO 2 POSTI 1 RLX 180	2 Motori - cod. 1243/1242 2 POSTI 2RLX SX-DX 154	2 Motori - cod. 1238/1237 2 POSTI 1 RLX SX-DX 154	2 M-cod. 1152/1151 POL. RLX SX-DX 90	2 M-cod. 1159 POLTRONA RLX CENTRALE 64
					cod. 0801 POUFI 41 75 75
					Diagramma di dettaglio con dimensioni: 57, h57, h41, 102, 160, 79, 86

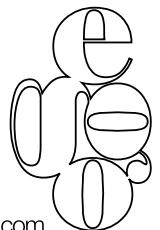

STRUTTURA In acciaio.

IMBOTTITURE Cuscino di seduta, braccioli e schienale sono realizzati in poliuretano espanso a densità differenziata. Tutte le parti sopraelencate sono ricoperte da una termofalda di dacron autoestinguente da 200 gr/mq.

Cuscino di seduta: densità 35 kg/mc.

Braccioli : densità 30 kg/mc.

Schienale: zona poggiatesta densità 25 kg/mc. Zona spalliera densità 23 kg/mc.

Imbottiture di completamento: densità 21 kg/mc.

RIVESTIMENTO Pelle o microfibra non sfoderabile. Per le caratteristiche del rivestimento e della manutenzione vedere relative schede tecniche.

PIEDI Base girevole in acciaio lucido. H: cm 14

NOTE La struttura della poltrona è costituita da un doppio telaio in acciaio denominato "frame in frame" con molle greche sulla seduta, dotato di due motori elettrici che agiscono indipendentemente l'uno dall'altro ed azionano il movimento dello schienale e della seduta.

I comandi sono posti sul fianco interno del bracciolo e comprendono i tasti di apertura/chiusura della seduta e dello schienale oltre al tasto reset che riporta la poltrona in posizione iniziale. I tasti si illuminano durante il funzionamento.

I meccanismi operano grazie a batterie al litio a lunga durata ricaricabili che ne permettono l'utilizzo anche lontano da una presa di corrente.

La parte superiore dello schienale può essere reclinata manualmente in avanti, tramite un cricchetto a scatti con ritorno a molla integrato nel telaio della spalliera, che rende più confortevole la lettura o la visione della TV.

STRUCTURE Stainless Steel.

PADDING Seat cushion, armrests and backrest are made of polyurethane foam with varying densities. All parts listed are covered with an acrylic layer of self-extinguishing dacron from 200 gr / mq.

Seat cushion: density 35 kg / mc.

Arms: density 30 kg / mc.

Backrest: Lumbar area density 25 kg / mc. Upper back density 23 kg / mc.

Frame Padding: density 21 kg / mc.

COVER Leather or non-removable microfiber. For the covering characteristics and maintenance instructions see relative data sheet.

FEET polished steel swivel base. H: 14 cm

NOTES The armchair structure is constituted by a double steel frame called "frame in frame" with no sags springs on the seat, equipped with two electric motors which act independently of one another and actuate the movement of the backrest and the seat.

The controls are located on the inner side of the armrest and include the opening / closing buttons for the seat and backrest in addition to the reset button which brings the chair back in its initial position. The control panel lights up during operation.

The mechanisms operate thanks to rechargeable long-life lithium battery that allow its use also away from a power outlet.

The upper part of the backrest can be reclined forward manually, via a ratchet mechanism with integrated return spring integrated into the backrest frame, thus making reading or watching TV more comfortable.

STRUCTURE Acier Inoxydable.

REMBOURRAGE Coussin d'assise, accoudoirs et dossier sont en mousse de polyuréthane à densités différenciées. Toutes les pièces énumérées sont recouvertes d'une couche acrylique de dacron anti-feu de 200 gr / mq.

Coussin d'assise: densité 35 kg / mc.

Accoudoir: densité 30 kg / mc.

Dossier: Partie cales reins densité 25 kg / mc. Partie supérieure dossier densité 23 kg / mc.

Rembourrage de complément: densité 21 kg / mc.

REVETEMENT Cuir ou microfibre non déhoussable. Pour les caractéristiques du revêtement et l'entretien voir la fiche de données relatives.

PIEDS base pivotante en acier poli. H: 14 cm

NOTES La structure du fauteuil est constitué par un double cadre d'acier nommé « frame in frame » ayant des ressorts nassags sous l'assise, équipé de deux moteurs électriques qui agissent indépendamment l'un de l'autre et actionnent le mouvement du dossier et de l'assise.

Le clavier de fonctionnement est situé sur le côté interne de l'accoudoir et comprend les touches d'ouverture / fermeture du siège et du dossier, aussi bien que de la touche de remise à zéro qui remet le fauteuil dans sa position initiale. Les touches s'allument pendant le fonctionnement.

Les mécanismes fonctionnent grâce à des batteries rechargeables au lithium à longue durée qui permettent son utilisation aussi loin d'une prise de courant.

La partie supérieure du dossier peut être inclinée vers l'avant manuellement, grâce à une mécanique cliquet avec ressort de retour intégré dans l'armature du dossier, ce qui rend la lecture ou regarder la télévision plus confortable.

POLTRONA GIREVOLE RELAX

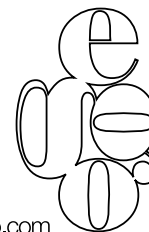
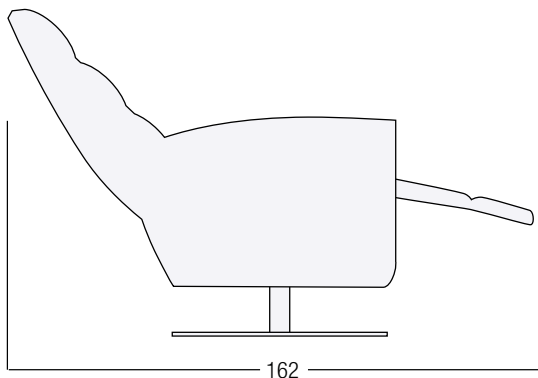
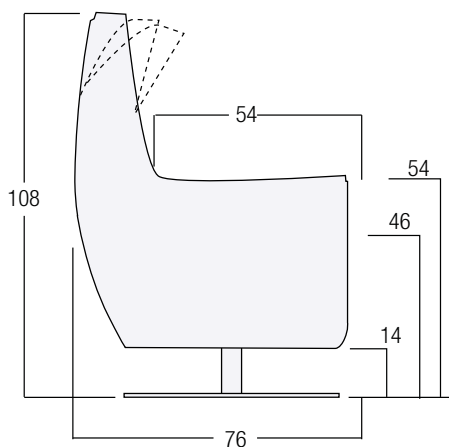
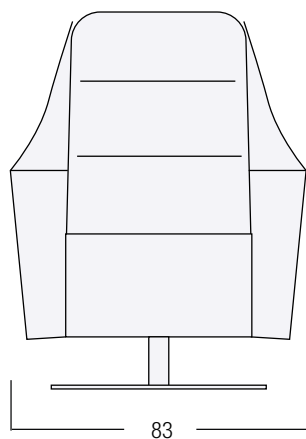

STRUTTURA Realizzata in acciaio. Disponibile nella finitura titanio o nei colori previsti sulle palette disponibili. Ripiano in legno massello di frassino in tinta noce canaletto o rovere naturale.

IMBOTTITURE Seduta realizzata in poliuretano espanso di densità 30 kg/mc.

RIVESTIMENTO Pelle o microfibra non sfoderabile. Per le caratteristiche del rivestimento e della manutenzione vedere relative schede tecniche.

NOTE Il pouf Sylt si trasforma in un tavolino velocemente e con un semplice gesto. Grazie alle scanalature create sul ripiano in legno, è sufficiente capovolgere il ripiano e poggiarlo sulla struttura per poterlo usare come comodo tavolino o come un semplice piano d'appoggio.

STRUCTURE Made of steel. Available in titanium finish or in the colors provided on the available palette. Solid ash wood shelf colored in Canaletto walnut or natural oak.

PADDING Seat made of polyurethane foam of density 30 kg / mc.
COVER Leather or non-removable microfiber. For the covering characteristics and maintenance instructions see relative data sheet.

COVER Leather or non-removable microfiber. For the covering characteristics and maintenance see relative data sheet.

NOTES The Sylt ottoman turns into a coffee table quickly and with a simple gesture. Thanks to the grooves on the wooden shelf, it is sufficient to overturn the top and place it on the structure in order to enjoy a convenient coffee table or as a simple support surface.

STRUCTURE Fabriqué en acier. Disponible en finition titane ou dans les couleurs fournies sur la palette disponible. solide étagère de bois de frêne en noyer noir ou chêne naturel.

REMBOURRAGE Siège en mousse de polyuréthane de densité 30 kg / mc.

REVETEMENT Peau ou microfibre non amovible. Pour les caractéristiques du revêtement et son entretien voir la fiche de données relatives.

NOTES Le pouf Sylt se transforme en une table basse rapidement et d'un simple geste. Grâce aux rainures créées sur le plateau en bois, il suffit de renverser le plateau et le placer sur la structure pour avoir une table basse où une simple surface de support..

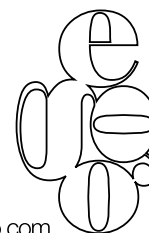
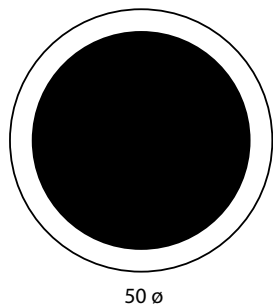
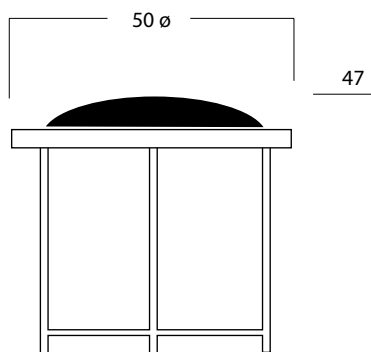
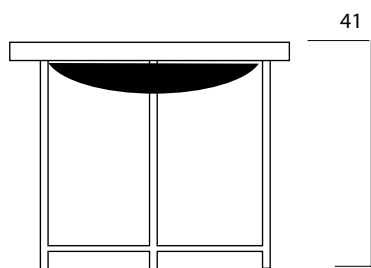

STRUTTURA Realizzata in legno abbinato a particelle di legno grezzo biodegradabile e pannelli di fibra di legno duro.

IMBOTTITURE Cuscino schienale realizzato in poliuretano espanso di densità 23 kg/mc. con zona poggiatesta di densità 25 kg/mc.

Cuscino di seduta realizzato in poliuretano espanso di densità 30 kg/mc.

Schienale e seduta sono ricoperti entrambi da una termofalda di dacron autoestinguente da 200 gr/mq. Le imbottiture di completamento sono realizzate in poliuretano espanso di densità 21 kg/mc.

RIVESTIMENTO Pelle o microfibra non sfoderabile. Per le caratteristiche del rivestimento e della manutenzione vedere relative schede tecniche.

PIEDI In legno massello di faggio evaporato tinto con vernici ecologiche all'acqua, nelle tinte noce, noce brunito, noce toffee, wenge. H= cm 12

NOTE la versione girevole della poltroncina poggia su una base girevole realizzata in acciaio lucido o finitura titanio e misura cm 17 in altezza e cm 58 di diametro.

E' possibile anche richiedere la base realizzata con finitura in vernici a polvere epossidica, nei colori bianco perla, grigio ombra e testa di moro.

FRAME Hardwood combined with plywood and particle board.

PADDING Backrest cushion in polyurethane foam with 23 kg/mc density, lumbar supports' density 25 kg/mc.

Seat cushion: In polyurethane foam, density 30 kg/mc.

Backrest and Seat : both covered with a layer of Dacron of 100 gr /sq m.

Backrest: In polyurethane foam 23 kg/m3, covered with a layer of Dacron of 200 gr /sq m. Frame padding: 21 kg/m3

COVERING Leather or microfiber. Not removable. Please check covering details for care instructions.

FEET In beech wood stained with ecological water based paints, available in walnut, dark walnut, Toffee colour or wengé. H. 12 cm .

NOTE in the swivel version of this armchair, the structure stands on a polished steel swivel base available also in colour titanium with a 58 cm diameter.

H 17 cm. The base is also available with an epoxy powder paint finish, in pearly white, shadow grey, or dark brown.

STRUCTURE En bois, multiplies et particules habillée d'une couche de dacron.

REMBOURRAGE Dossier: mousse de polyuréthane densité de 23 kg/mc, densité de support lombaire de 25 kg/mc.

Coussin d'assise: mousse polyuréthane, densité 30 kg/mc.

Dossiers et assise: couvert par une couche de dacron ignifugé de 200 gr/m2.

Rembourrage de complément : densité 21 kg/m3.

REVETEMENT Cuir ou microfibre non déhoussable. Pour les caractéristique du revêtement aussi bien que pour l'entretien veuillez consulter la fiches techniques appropriés.

PIEDS En bois de hêtre évaporé teinté avec peintures à l'eau écologique, disponible en coloris noyer, noyer foncé, toffee, wengé. H 12 cm.

NOTE La version pivotante du fauteuil repose sur une base pivotante en acier poli ou finition titane. H 17 cm, 58 cm de diamètre. Base disponible en poudre époxy, dans les couleurs perle blanche, ombre grise et brun foncé.

cod. 0164
POLTRONCINA

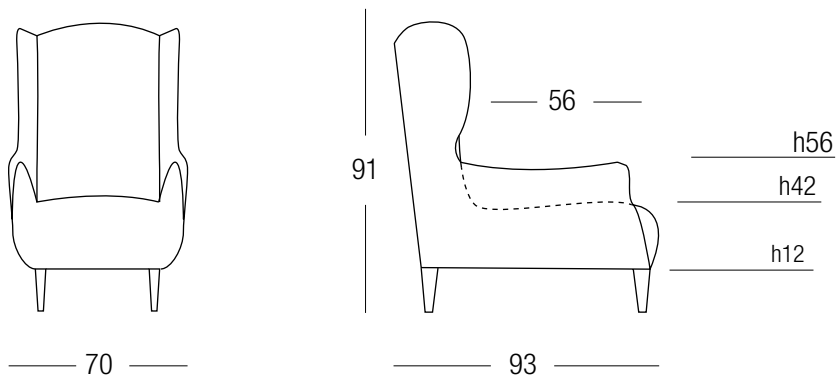

cod.0177
POLTRONCINA
XL

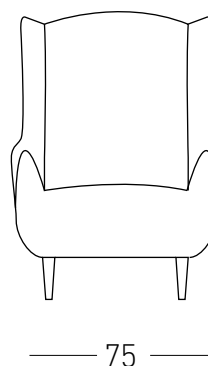

cod.0178
POLTRONCINA
GIREVOLE - XL

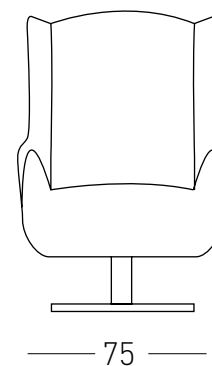

cod. 0123
POLTRONCINA
GIREVOLE

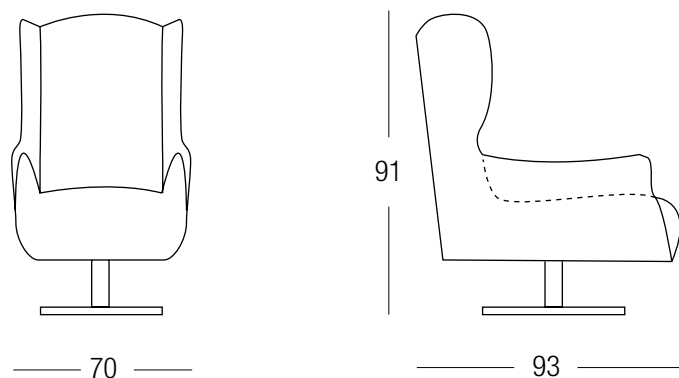

cod. 0801
POUF

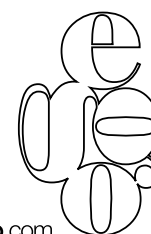
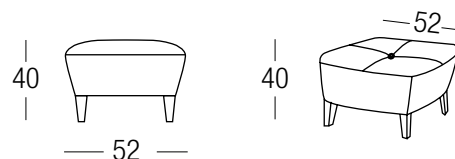

STRUTTURA Realizzata in legno abbinato a particelle di legno grezzo biodegradabile e pannelli di fibra di legno duro.

IMBOTTITURE Cuscino schienale: in poliuretano espanso di densità 23 kg/mc.

Poggiareni di densità 25 kg/mc.

Cuscino di seduta: in poliuretano espanso di densità 30 kg/mc.

Schienale e seduta: ricoperti entrambi da una termofalda di dacron autoestingente da 200 gr/ mq. Le imbottiture di completamento: realizzate in poliuretano espanso di densità 21 kg/mc.

RIVESTIMENTO Pelle, tessuto o microfibra non sfoderabile. Per le caratteristiche del rivestimento e della manutenzione vedere relative schede tecniche.

PIEDI In legno massello di faggio evaporato tinto con vernici ecologiche all'acqua, nelle tinte noce, noce brunito, noce toffee, wenge. H= cm 12

FRAME Hardwood combined with plywood and particle board.

PADDING Back cushion: in polyurethane foam, density 23 kg/mc.

Lumbar support: density 25 kg/mc.

Seat cushion: polyurethane foam, density 30 kg/mc.

Backrest and seat: covered with a layer of Dacron of 200 gr /sq m.

Frame padding: polyurethane foam, density 21 kg/m3.

COVERING Leather or microfiber. Not removable. Please check covering details for care instructions.

FEET In beech wood stained with ecological water based paints, available in walnut, dark walnut, Toffee colour or wengé. H. 12 cm .

STRUCTURE En bois, multiples et particules habillée d'une couche de dacron.

REMBOURRAGE Dossier: polyuréthane expansé, densité 23 kg/m3.

Cale-reins: densité 25 kg/m3.

Assise: en polyuréthane expansé densité 30 kg/m3

Dossiers et assise: couvert par une couche de dacron ignifugé de 200 gr/m2.

Rembourrage de complément : densité 21 kg/m3.

REVETEMENT Cuir ou microfibre non déhoussable. Pour les caractéristique du revêtement aussi bien que pour l'entretien veuillez consulter la fiches techniques appropriés.

PIEDS En bois de hêtre évaporé teinté avec peintures à l'eau écologique, disponible en coloris noyer, noyer foncé, toffee, wengé. H 12 cm.

cod. 0164

POLTRONCINA

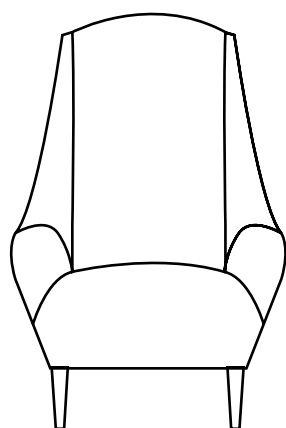

73

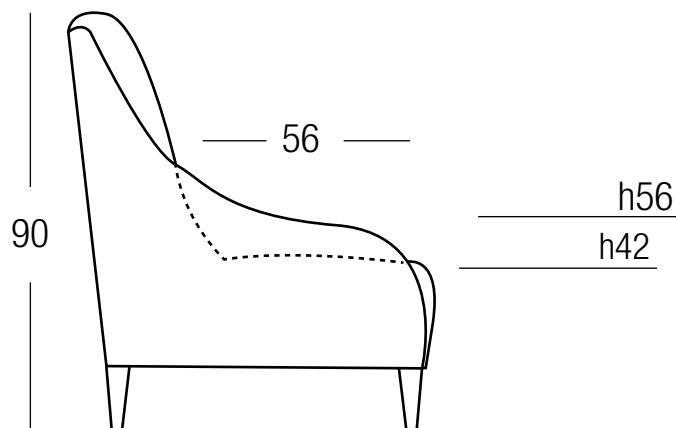

94

cod. 0801

POUF

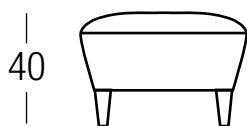

40

52

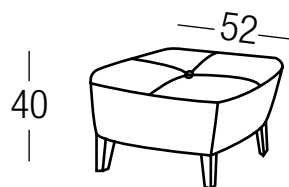

52

40

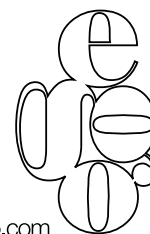

STRUTTURA Realizzata in legno multistrato con rinforzi in metallo.

IMBOTTITURE Cuscino schienale e cuscino di seduta realizzati in poliuretano espanso di densità 30 kg/mc. Schienale e seduta sono ricoperti entrambi da una termofalda di dacron autoestinguente da 200 gr/ mq.

RIVESTIMENTO Pelle, tessuto o microfibra non sfoderabile. Per le caratteristiche del rivestimento e della manutenzione vedere relative schede tecniche.

PIEDI Struttura in acciaio verniciato con polveri epossidiche nei colori nero opaco, grigio ombra, testa di moro, bianco, oppure realizzabile nelle finiture titanio o acciaio lucido.

FRAME Multilayer wood with metal supports.

PADDING Back and seat cushion: in polyurethane foam, density 30 kg/mc. Backrest and seat: covered with a layer of Dacron of 200 gr /sq m.

COVERING Leather or microfiber. Not removable. Please check covering details for care instructions.

FEET In steel stained with epoxy powder paints, available in mat black, shadow grey, dark brown, white. Also available with steel or titanium finish.

STRUCTURE bois multicouche avec renforts métalliques.

REMBOURRAGE Dossier et assise: polyuréthane expansé, densité 30 kg/m3. Couvert par une couche de dacron ignifugé de 200 gr/m2.

REVETEMENT Cuir ou microfibre non déhoussable. Pour les caractéristique du revêtement aussi bien que pour l'entretien veuillez consulter la fiches techniques appropriés.

PIEDS acier peint avec poudres époxy en noir mat, gris foncé, marron, blanc ou en titane ou en acier poli.

cod. 0164
POLTRONCINA

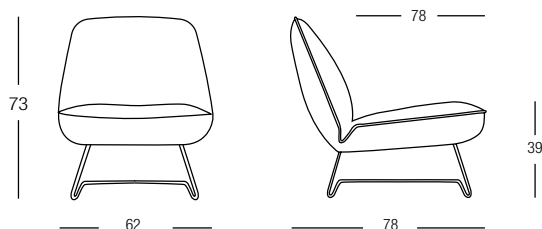

cod. 0900
SGABELLO

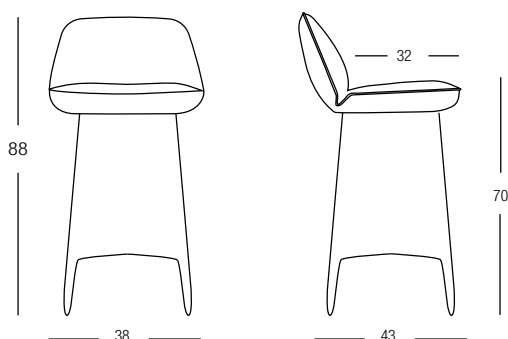

cod. 0899
SEDIA

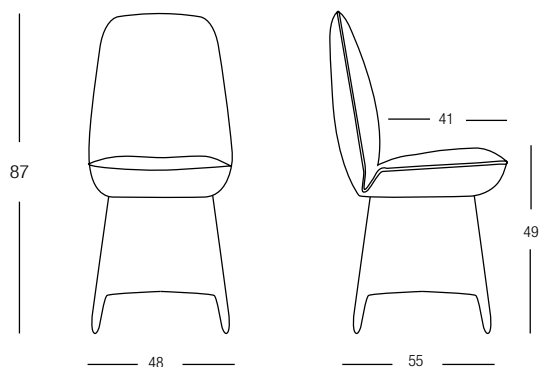

cod. 0801
POUF

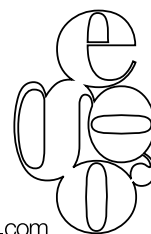
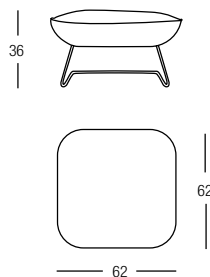

RIVESTIMENTO Pelle o microfibra non sfoderabile. Per le caratteristiche del rivestimento e della manutenzione vedere relative schede tecniche.

IMBOTTITURA Braccioli, poggiatesta e spalliere poggiatesta reclinabili sono realizzate in poliuretano espanso a densità differenziate. Tutte le parti sopraelencate sono ricoperte da una termofalda di dacron autoestinguente.

Cuscini di seduta: strato superiore: densità 30 kg/mc. soffice. Strato inferiore: densità 35 kg/mc. portante. Termofalda in dacron resinato da 200 gr/mq. Braccioli: densità 30 kg/mc. Termofalda da 200 gr/mq. Poggiatesta: densità 25 kg/mc. Termofalda da 350 gr/mq.

Spalliere poggiatesta: densità 25 kg/mc. Termofalda da 350 gr/mq. Imbottiture di completamento: densità 21 kg/mc.

PIEDI Struttura in metallo verniciato con colori a base di polveri epossidiche nelle tinte previste sulle palette disponibili.

STRUTTURA Realizzata in legno abbinato a particelle di legno grezzo biodegradabile e pannelli di fibra di legno duro.

NOTE Gli schienali sono dotati di meccanismo manuale a cricchetto, reclinabili a seconda del comfort desiderato.

COVERING Leather or microfiber. Not removable. Please check covering details for care instructions.

PADDING Armrests, lumbar supports, backrests and headrests are made in polyurethane foam with varying density. All of the above parts are covered with a Dacron layer. Seat cushions: upper part: 30 kg/m3 "soft comfort". Bottom part: 35 kg/m3 "hard comfort". Dacron layer 200 gr/m2. Armrests: Polyurethane foam 30 kg/m3 covered in dacron 200 gr/m2. Lumbar supports: Polyurethane foam 25 kg/m3 covered in dacron 350 gr/m2. Headrests: 25 kg/m3. Dacron layer 350 gr/m2. Frame padding: 21 kg/m3

FEET In metal finished with epoxy powders. Available in its corresponding colour palette. H 16 cm.

FRAME Hardwood combined with plywood and particle board.

NOTE Headrests and armrests are equipped with manual adjustable mechanism that allows you to find the desired comfort position.

REVÊTEMENT Cuir ou microfibre non déhoussable. Pour les caractéristique du revêtement aussi bien que pour l'entretien veuillez consulter les fiches techniques appropriés.

REMBOURRAGE Accoudoirs, cales-reins, dossiers et appuie-tête en polyuréthane expansé à double densité. Toutes les parties susdites sont recouvertes avec une couche de dacron. Coussins d'assise : Partie supérieure polyuréthane expansé 30 kg/m3 (souple), partie inférieure polyuréthane expansé 35 kg/m3 portante. Dacron 200 gr/m2. Accoudoirs: Polyuréthane expansé 30 kg/m3 recouvert en dacron 200 gr/m2. Cales-reins: Polyuréthane expansé 25 kg/m3 recouvert en dacron 350 gr/m2. Appuie-tête : 25 kg/m3. Dacron 350/m2. Rembourrage de complément : densité 21 kg/m3.

PIEDS En métal fini avec poudre epoxy disponible dans sa palette de couleurs. H 16 cm.

STRUCTURE En bois, multiplies et particules habillés d'une couche de dacron.

NOTE Les appuie-têtes et les accoudoirs sont équipés d'une mécanique manuelle qui permet de chercher la position désirée.

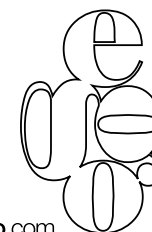
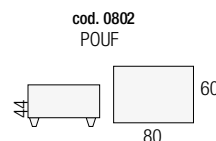
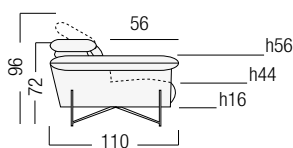
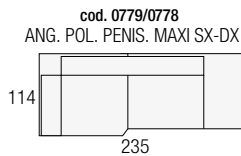
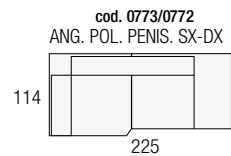
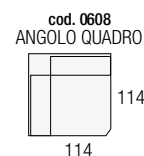
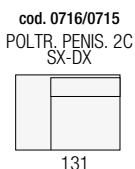
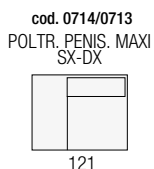
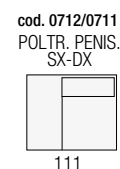
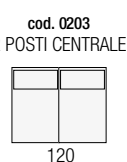
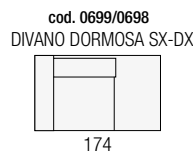
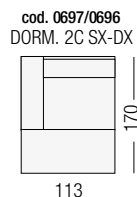
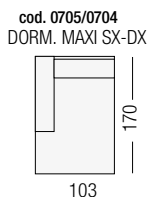
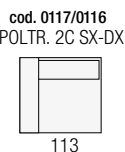
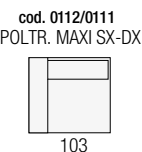
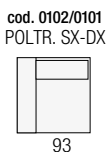
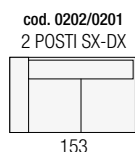
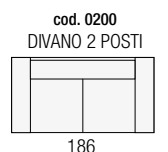
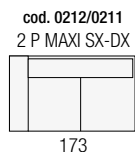
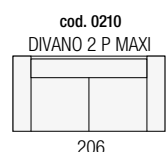
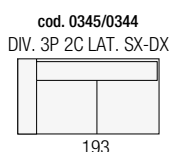
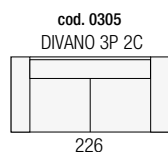

RIVESTIMENTO Pelle o microfibra non sfoderabile. Per le caratteristiche del rivestimento e della manutenzione vedere relative schede tecniche.

IMBOTTITURA Cuscini di seduta, braccioli, poggiatesta e spalliere poggiatesta reclinabili sono realizzate in poliuretano espanso a densità differenziata. Tutte le parti sopraelencate sono ricoperte da una termofalda di dacron autoestinguente. Cuscini di seduta: densità 30 kg/mc. falda di dacron da 200 gr/mq. Braccioli: densità 30 kg/mc. Termofalda da 400 gr/mq. Spalliere poggiatesta e poggiatesta: densità 25 kg/mc. Termofalda da 350 gr/mq. Imbottiture di completamento: densità 21 kg/mc.

PIEDI In metallo verniciato con polveri epossidiche nei colori previsti sulle palette disponibili. H alla base del divano: cm 13.

STRUTTURA Realizzata in legno abbinato a particelle di legno grezzo biodegradabile e pannelli di fibra di legno duro.

NOTE Nella versione relax il modello è realizzato con meccanismo combinato con movimento schienale poggiatesta, disponibile esclusivamente in versione elettrica con comando posizionato sul lato esterno del divano. L'elemento relax è sempre staccato da quello fisso e viene agganciato con apposito sistema a baionetta.

COVERING Leather or microfiber. Not removable. Please check covering details for care instructions.

PADDING Seat cushion, armrests, lumbar supports and backrests-headrests are made in polyurethane foam with varying density. Every part mentioned above is covered by a Dacron layer. Seat cushions: In polyurethane foam 30 kg/m3. Covered by a dacron layer 200 gr/m2. Armrests: Polyurethane foam 30 kg/m3. Dacron layer 350 gr/m2. Backrests-headrests and lumbar supports: Polyurethane foam 25 kg/m3. Dacron layer 350 gr/m2.

Frame padding: Polyurethane foam 21 kg/m3.
FEET In metal finished with epoxy powder in the optional colours available in its palette. Height to the base of the sofa 13cm.

FRAME Hardwood combined with plywood and particle board.

NOTE The relax version comes with electric movements only. Controls are placed on the armrest side, whilst armless units are equipped with practical touch sensor buttons placed on the side of the seat cushion itself. Elements with relax mechanism are always delivered separately and connected to the fixed parts by made for purpose bayonet fittings. Fixed versions are always equipped with mechanical headrests mechanism.

REVÊTEMENT Cuir ou microfibre non déhoussable. Pour les caractéristique du revêtement aussi bien que pour l'entretien veuillez consulter les fiches techniques appropriées.

REMBOURRAGE Coussins d'assise, accoudoirs, cale reins et dossiers appui-tête en polyuréthane expansé à densité différenciée. Toutes les partie indiquées sont couverte par une couche de dacron. Coussins d'assise: en polyuréthane expansé 30 kg/m3. Couche en dacron 200 gr/m2. Accoudoirs: Polyuréthane expansé 30 kg/m3 recouvert avec une couche de dacron 350 gr/m2. Dossiers appui-tête et cale reins: Polyuréthane expansé 25 kg/m3 recouvert avec une couche de dacron 350 gr/m2. Rembourrage de complément : densité 21 kg/m3.

PIEDS En métal vernis avec poudre epoxy dans les coloris disponibles prévus dans sa palette. Hauteur à la base du canapé 13 cm.

STRUCTURE En bois, multiples et particules habillés d'une couche de dacron.

NOTE En version relax le modèle est réalisé exclusivement avec relax électrique ayant sa commande située sur la partie latérale extérieure de l'accoudoir. Les éléments avec relax sont toujours séparés des éléments fixes et reliés avec un système à baïonnette. Les versions fixes sans relax sont en tout cas toujours équipées avec mécanique à crémaillère des appui tête. Les assises centrales sont équipées avec bouton Touch control placé sur le coté de l'assise.

VERSIONI CON MECCANISMO RELAX AZIONABILE SOLO ELETTRICAMENTE.

<p>cod. 0430 DIVANO 3 P GRANDE 228</p>	<p>cod. 0432/0431 3 P GRANDE LAT. SX-DX 205</p>	<p>cod. 0109/0108 POLTRONA GRANDE SX-DX 114</p>	<p>cod. 0104 POLTR. GRANDE CENTRALE 91</p>	<p>cod. 1440 3 POSTI GRANDE - 2 RLX 228</p>	<p>cod. 1445/1444 3 P GRANDE - 1 RLX SX-DX 228</p>	<p>cod. 1448/1447 3 P GRANDE LAT. SX-DX - 2 RLX 205</p>	<p>cod. 1442/1441 3 P GRANDE LAT. SX-DX - 1 RLX 205</p>			
<p>cod. 0305 DIVANO 3P 2C 202</p>	<p>cod. 0345/0344 DIV. 3P 2C LAT. SX-DX 179</p>	<p>cod. 0117/0116 POLTR. 2C SX-DX 101</p>	<p>cod. 0115 POLTR. 2C CENTRALE 78</p>	<p>cod. 1342 DIV. 3P 2C - 2 RLX 202</p>	<p>cod. 1341/1340 DIV. 3P 2C - 1 RLX SX-DX 202</p>	<p>cod. 1339/1338 DIV. 3P 2C SX-DX - 1 RLX 179</p>	<p>cod. 1378/1377 DIV. 3P 2C SX-DX - 2 RLX 179</p>			
<p>cod. 0210 DIVANO 2 P MAXI 182</p>	<p>cod. 0212/0211 DIV. 2 P MAXI LAT. SX-DX 159</p>	<p>cod. 0112/0111 POL. MAXI SX-DX 91</p>	<p>cod. 0113 POLTR. MAXI CENTRALE 68</p>	<p>cod. 1230 DIV. 2 P MAXI - 2 RLX 182</p>	<p>cod. 1216/1215 2 P MAXI - 1 RLX SX-DX 182</p>	<p>cod. 1232/1231 2 P MAXI SX-DX - 1 RLX 159</p>	<p>cod. 1228/1227 2 P MAXI SX-DX - 2 RLX 159</p>			
<p>cod. 0200 DIVANO 2 POSTI 160</p>	<p>cod. 0202/0201 2 POSTI LAT. SX-DX 137</p>	<p>cod. 0203 2 POSTI CENTRALE 114</p>		<p>cod. 1220 DIV. 2 P - 2 RLX 160</p>	<p>cod. 1206/1205 DIVANO 2 P - 1 RLX SX-DX 160</p>	<p>cod. 1222/1221 2 P SX-DX - 1RLX 137</p>	<p>cod. 1225/1224 2 P SX-DX - 2 RLX 137</p>			
<p>cod. 0100 POLTRONA 103</p>	<p>cod. 0102/0101 POLTR. LAT. SX-DX 80</p>	<p>cod. 0103 POLTR. CENTRALE 57</p>		<p>cod. 1120 POLTR. RLX 103</p>	<p>cod. 1135/1134 POL. GRANDE SX-DX RLX 114</p>	<p>cod. 1143/1142 POL. 2C SX-DX RLX 101</p>	<p>cod. 1125/1124 POL. MAXI SX-DX RLX 91</p>	<p>cod. 1122/1121 POL. SX-DX - RLX 80</p>		
<p>cod. 0176 POLTR. XL 166</p>	<p>cod. 0192/0191 POLTR. XL LAT. SX-DX 143</p>	<p>cod. 0193 POLTR. XL CENTRALE 120</p>		<p>cod. 1147 POLTR. XL - RLX 166</p>	<p>cod. 1137/1136 POLTR. XL LAT. SX-DX - RLX 143</p>	<p>cod. 1138 POLTR. XL CENTRALE - RLX 120</p>	<p>cod. 1433 POLTR. GRANDE CENTR. - RLX 91</p>	<p>cod. 1162 POLTR. CENTR 2C - RLX 78</p>	<p>cod. 1128 POLTR. MAXI CENTR - RLX 68</p>	<p>cod. 1118 POLTR. CENTRALE - RLX 57</p>
<p>cod. 0718/0717 POLTRONA XL PENIS. LAT. SX-DX 161</p>	<p>cod. 0738/0737 POLTRONA GRANDE PENIS. LAT. SX-DX 132</p>	<p>cod. 0716/0715 POLTRONA 2C PENIS. LAT. SX-DX 119</p>	<p>cod. 0714/0713 POLTRONA MAXI PENIS. LAT. SX-DX 109</p>	<p>cod. 0712/0711 POLTRONA PENIS. LAT. SX-DX 98</p>						<p>cod. 0800 POUF RETT. 65 80</p>
<p>cod. 0701/0700 DORM. LAT. SX-DX 163 80</p>	<p>cod. 0705/0704 DORM. MAXI SX-DX 91</p>	<p>cod. 0697/0696 DORM. 2C SX-DX 101</p>	<p>cod. 0789/0788 DORM. GRAN. SX-DX 114</p>	<p>cod. 0891/0890 DORM. XL SX-DX 123</p>	<p>cod. 0771/0770 TERM. TRAPEZIO SX-DX 155 107 123</p>	<p>cod. 0883/0882 ANG. SAG. POL. PENIS. SX-DX 126 41 203</p>	<p>cod. 0773/0772 ANG. POL. PENISOLA SX-DX 115 224</p>	<p>cod. 0602 ANGOLO 136 136</p>	<p>cod. 0608 ANG. QUADRO CON MECC. 115 115</p>	

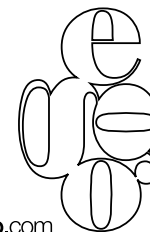

STRUTTURA Realizzata in legno abbinato a particelle di legno grezzo biodegradabile e pannelli di fibra di legno duro.

IMBOTTITURE Cuscini di seduta, braccioli, poggiatesta e spalliere poggiatesta reclinabili sono realizzate in poliuretano espanso a densità differenziate. Tutte le parti sopraelencate sono ricoperte da una termofalda di dacron autoestinguente.

Cuscini di seduta: strato superiore: densità 30 kg/mc. Strato inferiore: densità 35 kg/mc, rivestiti con falda di dacron in fibra di poliestere da 100 gr/mq. Poggiatesta: densità 30 kg/mc. Termofalda di dacron in fibra di poliestere da 450 gr/mq. Braccioli: densità 40 kg/mc. Doppia falda di dacron resinato da 200 gr/mq. Spalliere poggiatesta: densità 23 kg/mc. Termofalda di dacron in fibra di poliestere da 450 gr/mq.

Imbottiture di completamento: densità 21 kg/mc.

RIVESTIMENTO Pelle o microfibra non sfoderabile. Per le caratteristiche del rivestimento e della manutenzione vedere relative schede tecniche.

PIEDI In ABS. H = cm 4

NOTE Nella versione relax il modello è dotato esclusivamente di meccanismo elettrico con comando posizionato sul lato esterno del divano, mentre le sedute centrali sono dotate di un pratico telecomando. I comandi possono agire indipendentemente tra di loro variando solo l'inclinazione della testiera oppure permettendo di distendere solo le gambe offrendo infinite possibilità di comfort. Gli elementi relax sono sempre staccati da quelli fissi e vengono agganciati con apposito sistema a baionetta. Nelle versioni fisse senza meccanismo relax in ogni caso è presente il cricchetto manuale nelle testiere. I braccioli sono corredati di una struttura metallica con funzione puramente estetica, verniciata con colori a base di polveri epossidiche nelle tinte previste sulle palette disponibili.

COVERING Leather, microfiber or fabric. Not removable.

PADDING Seat cushion, armrest, kidney rest and headrest: double density polyurethane foam covered with a Dacron layer.

Seat cushion: upper part: 30kg/m³ "soft comfort". Bottom part: 35 kg/m³ "normal comfort". Dacron layer: 100 gr/m². Kidney rest: 30kg/m³. Dacron layer: 450 gr/m². Armrest: 40kg/m³. Dacron layer: 200 gr/m².

Headrest: 23 kg/m³. Dacron layer 450 gr/m²

FRAME Hard wood combined with plywood and particle board covered with a Dacron layer.

FEET ABS feet. Height 4 cm

NOTE Model equipped with "double motor" electric recliner mechanism for an independent movement of the backrest and the foot rest. Fixed versions are always equipped with manually adjustable headrest. Armrests come with a purely decorative metal structure finished with epoxy powder, available in its corresponding colour palette

STRUCTURE En bois massif, multiplis et particules habillés d'une couche de dacron.

REMBOURRAGE Coussins d'assise, cale-reins, accoudoirs et appuie-tête réclinables réalisés en polyuréthane écologique à double densité recouvert avec une couche de dacron.

Coussins d'assise: Partie supérieure 30 Kg/m³. Partie inférieure: 35 Kg/m³. Recouvert d'une couche de Dacron 100gr/m². Cale-reins: densité 40 Kg/m³. Dacron 450 gr/m². Accoudoirs: densité 40 Kg/m³. Dacron 200 gr/m². Appuie-tête: densité 23 Kg/m³. Dacron 450 gr/m²

Rembourrage de complément: densité 21 Kg/m³

REVEITEMENT Cuir ou microfibre non déhoussable.

PIEDS En bois massif teinté wengé avec profil chromé, h 4 cm

NOTE La version est exclusivement relax électrique, actionnable avec commande électrique positionnée sur le côté externe de l'accoudoir, le relax central est quand à lui doté d'une télécommande. Les commandes peuvent agir indépendamment les uns des autres, variant seulement l'inclinaison de l'appuie-tête ou bien permettant d'étendre les jambes, offrant de nombreuses possibilités pour le confort.

L'élément relax est toujours détaché du fixe et est attaché à ce dernier par un système spécifique à baionnette.

L'élément fixe sans relax est doté de mécanisme manuel au niveau des appuie-tête. Les accoudoirs ont une structure purement décorative en métal, fini avec poudre epoxy disponible dans sa palette de couleurs

VERSIONI CON MECCANISMO RELAX AZIONABILE SOLO ELETTRICAMENTE.

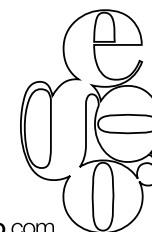
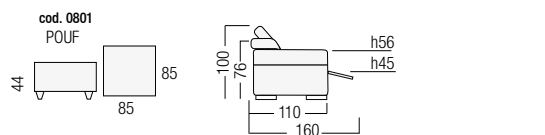
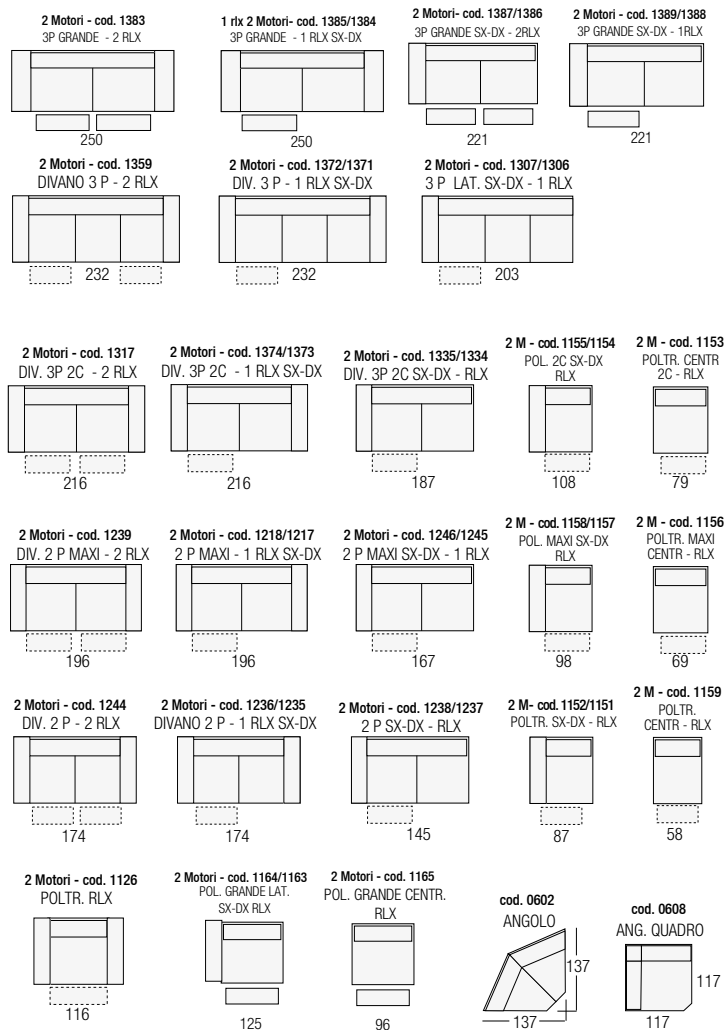
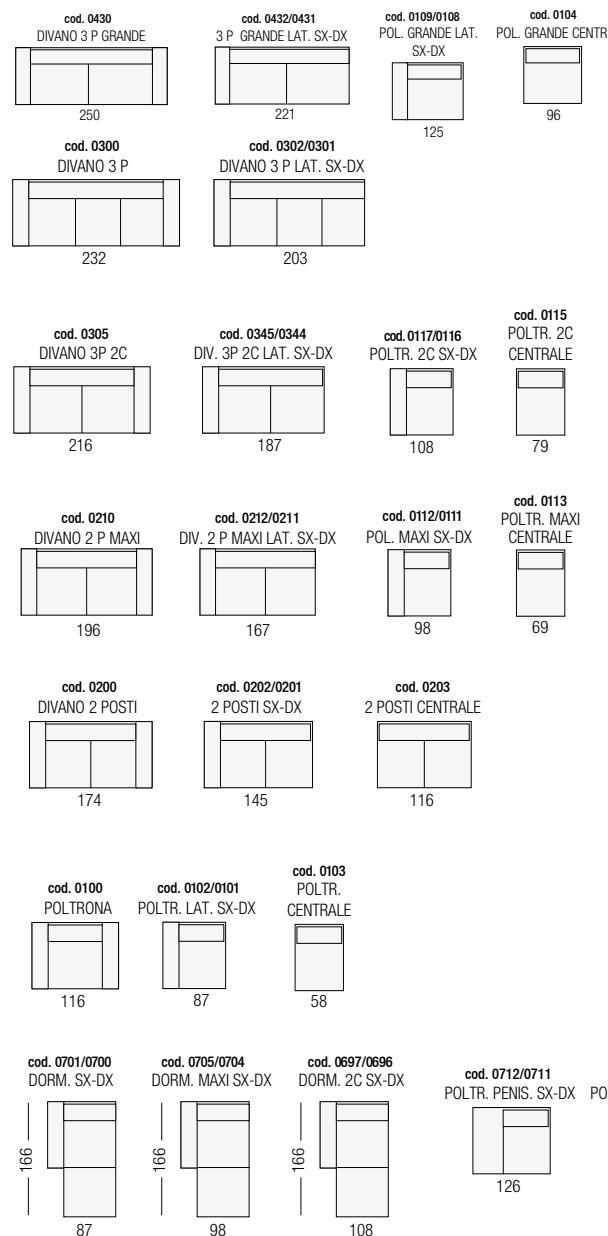

RIVESTIMENTO Pelle o microfibra non sfoderabile. Tessuto sfoderabile. Per le caratteristiche del rivestimento e della manutenzione vedere relative schede tecniche.

IMBOTTITURE Cuscino di spalliera in poliuretano espanso 35kg/mc. Inserto rivestito in piuma d'oca. Cuscino di seduta realizzato in poliuretano espanso a doppia densità: STRATO SUPERIORE di densità 35kg/mc rivestito da uno strato di Dacron resinato da 200gr/mq. STRATO INFERIORE 35kg/mc di densità.

STRUTTURA in legno massello frassino o rovere, disponibile in due tinte, rovere naturale o noce canaletto.

COVERING Leather or microfiber not removable. Or removable fabric. Please check covering details for care instructions.

PADDING Backrests cushion made in polyurethane foam, density 35 Kg/mc. Insert covered in goose feather. Seat cushion made of polyurethane foam with double density: TOP LAYER 35kg/MC density covered with a 200gr/MQ layer of resined Dacron. LOWER LAYER 35kg/MC density.

FRAME solid ash or oak wooden structure, available in two colors, natural oak or Canaletto walnut.

REVETEMENT en cuir ou microfibre non amovible. Tissu amovible. Pour les caractéristiques du revêtement et de l'entretien, voir les fiches techniques pertinentes.

REMBOURRAGE Coussins rembourrés en mousse polyuréthane 35KG/MC. Insert couvert de plumes d'oie. Coussin de siège en mousse de polyuréthane à double densité: couche supérieure de densité 35KG/MC recouverte d'une couche de Dacron résineuse par 200gr/mq. Couche inférieure de densité 35KG/MC.

STRUCTURE en frêne massif ou en chêne, disponible en deux couleurs, en chêne naturel ou en noyer de bois.

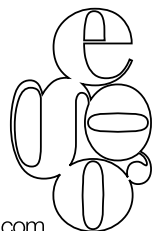
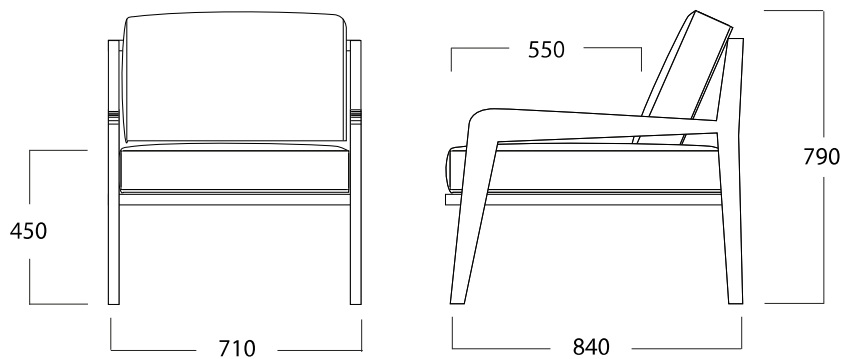

RIVESTIMENTO Pelle, microfibra o tessuto non sfoderabile. Per le caratteristiche del rivestimento e della manutenzione vedere relative schede tecniche.

IMBOTTITURE Cuscino di seduta in poliuretano espanso a doppia densità:

STRATO SUPERIORE di densità 30kg/mc rivestito da una termofalda di Dacron da 350gr/mq. STRATO INFERIORE 35kg/mc di densità. Schienali in poliuretano espanso, tampone superiore da 40kg/mq, Schiena da 23 kg/mc ricoperto da una termofalda di Dacron da 350gr/mq. Braccioli in poliuretano espanso da 40kg/mq di densità, rivestito da uno strato di Dacron resinato da 200gr/mq. Imbottiture di completamento da 21kg/mc.

STRUTTURA Realizzata in legno abbinato a particelle di legno grezzo biodegradabile e pannelli di fibra di legno duro.

PIEDI basi a cornice realizzate in legno massello di frassino o rovere, nelle colorazioni rovere naturale e noce canaletto.

NOTE Il modello è composto da moduli liberamente e facilmente accostabili tra loro tramite semplici agganci in legno massello di faggio, i quali vengono semplicemente posti ad incastro nei punti predisposti sotto le basi dei vari elementi. I cuscini di seduta sono impreziositi da tiranti in acciaio laccati, dal design esclusivo e specifico per il modello.

COVERING Leather, microfiber or fabric not removable. Please check covering details for care instructions.

PADDING Seat cushion padding in double density polyurethane foam: 30kg/MC density top layer covered with a 350gr/MQ Dacron layer. Lower layer 35kg/MC density. Backs in polyurethane foam, upper 40kg/sqm buffer, 23 kg/MC Backrest covered with a 350gr/MQ Dacron layer. armrests in polyurethane foam 40kg/sqm density, covered with a layer of resined Dacron of 200gr/MQ.

FRAME Hard wood combined with plywood and particle board covered with a Dacron layer.

FEET base frame made of solid oak or ash wood, available in the colors natural oak and canaletto walnut.

NOTES The model consists of modules freely and easily joinable together via hooks in solid beech wood, which are simply placed in arranged slots beneath the bases of the various elements. The seat cushions are embellished with lacquered steel rods, with exclusive design and specific for the model.

REVETEMENT en cuir ou microfibre non amovible. Tissu amovible. Pour les caractéristiques du revêtement et de l'entretien, voir les fiches techniques pertinentes.

REMBOURRAGE coussin de siège en mousse polyuréthane à double densité: couche supérieure de densité 30 kg/mc couverte d'une surface d'eau 350gr/MQ Dacron. Couche de densité 35KG/MC inférieure. Dos en mousse de polyuréthane, tampon 40kg/sqm supérieur, dossier 23 kg/mc recouvert d'une couche Dacron 350gr/mq. accoudoirs en mousse de polyuréthane de 40kg/m² de densité, couverts par une couche de Dacron résineux par 200gr/mq. Remplissage d'achèvement de 21kg/MC.

STRUCTURE en bois combinée avec des particules de bois brut biodégradables et des panneaux faits de fibre de bois dur.

PIEDS en frêne massif ou en bois de chêne, en chêne naturel et en noyer de couleur.

NOTE Le modèle est composé de modules librement et facilement couplés les uns avec les autres par des connexions simples en bois de hêtre massif, qui sont simplement placés en place aux points disposés sous les bases des différents éléments. Les coussins de siège sont embellis avec des tiges en acier laqué, avec un design exclusif et spécifique pour le modèle.

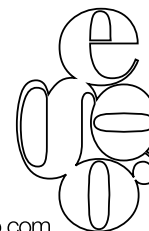
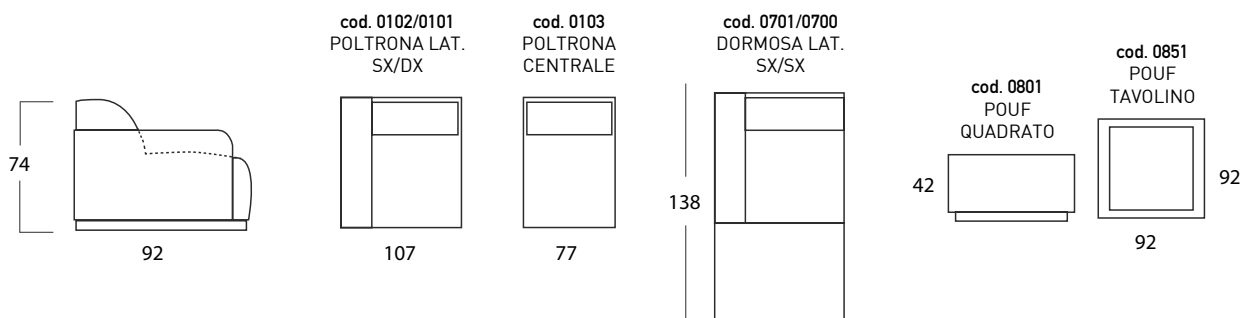

STRUTTURA in legno massello frassino o rovere, disponibile in due tinte, rovere naturale o noce canaletto.

RIVESTIMENTO Cover intercambiabile in pelle, microfibra o tessuto. Per le caratteristiche del rivestimento e della manutenzione vedere relative schede tecniche.

NOTE La cover segue il ripiano del tavolino fino a ripiegarsi su se stessa per diventare una tasca multi funzionale per riviste ed accessori hi tech. Bergen dispone anche di un vassoio estraibile che può completarne il design e ne valorizza la sua funzionalità e versatilità.

STRUCTURE Structure in solid wood ash or oak, available in two colours, natural oak or Canaletto walnut.

COVER Interchangeable covering in leather, microfiber or fabric. For the characteristics of the coating and the maintenance see relevant technical sheets.

NOTES This cover follows the table top and turns inward to become a multi functional pocket for magazines and hi tech accessories. Bergen can also be equipped with a removable oak tray that can complete its design and enhances its functionality and versatility.

STRUCTURE Structure en frêne massif ou en chêne, disponible en deux couleurs, en chêne naturel ou en noyer de bois.

REVETEMENT Couvrez interchangeable en cuir, microfibre ou tissu. Pour les caractéristiques du revêtement et de l'entretien, voir les fiches techniques pertinentes.

NOTES le couvercle suit l'étagère de la table jusqu'à ce qu'il se replie sur lui-même pour devenir une poche multi-fonctionnelle pour les magazines et les accessoires hi-tech. Bergen dispose également d'un plateau amovible qui peut compléter sa conception et améliorer sa fonctionnalité et sa polyvalence.

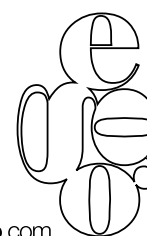
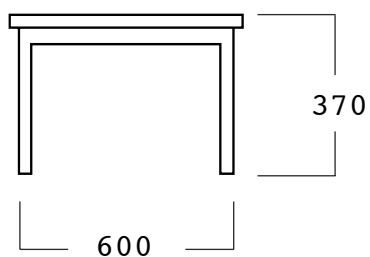
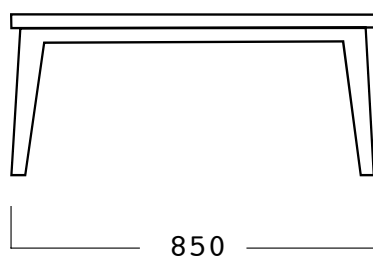
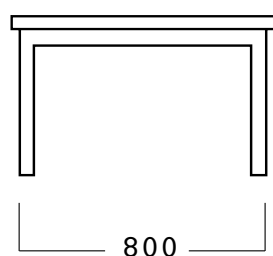

STRUTTURA in legno massello frassino o rovere, disponibile in due tinte, rovere naturale o noce canaletto.

IMBOTTITURE Seduta realizzata in poliuretano espanso di densità 21 kg/mc.

RIVESTIMENTO Pelle, microfibra o tessuto non sfoderabile. Per le caratteristiche del rivestimento e della manutenzione vedere relative schede tecniche.

NOTE Il pouf Malmo è dotato di una fascia decorativa sulla spalliera che è intercambiabile.

STRUCTURE Structure in solid wood ash or oak, available in two colours, natural oak or Canaletto walnut.

PADDING Seat padding made of 21 kg/MC density polyurethane foam.

COVER Covering leather, microfiber or non-removable fabric. For the characteristics of the coating and the maintenance see relevant technical sheets.

NOTES the Malmo Pouf features a decorative headband on the back which is interchangeable.

STRUCTURE Structure en frêne massif ou en chêne, disponible en deux couleurs, en chêne naturel ou en noyer de bois.

REMBOURRAGE Siège en mousse de polyuréthane de densité 21kg / mc.

RETEMENT Pelle, microfibra o tessuto non sfoderabile. Per le caratteristiche del rivestimento e della manutenzione vedere relative schede tecniche.

NOTES le pouf de Malmö dispose d'un bandeau décoratif sur le dos qui est interchangeable.

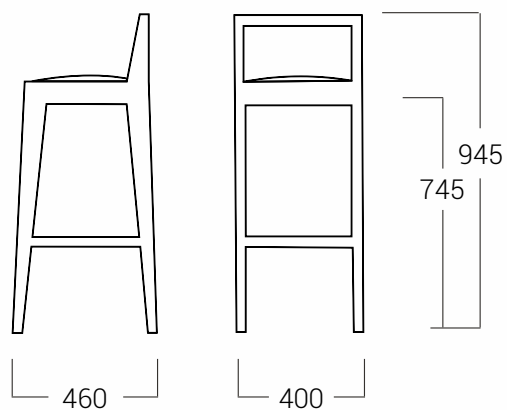

STRUTTURA Realizzata in legno abbinato a particelle di legno grezzo biodegradabile e pannelli di fibra di legno duro.

IMBOTTITURE Cuscini di seduta, braccioli, poggiatesta e spalliere poggiatesta reclinabili sono realizzate in poliuretano espanso a densità differenziate. Tutte le parti sopraelencate sono ricoperte da una termofalda di dacron autoestinguente.

Cuscini di seduta: strato superiore: densità 30 kg/mc. Strato inferiore: densità 35 kg/mc, rivestiti con falda di dacron in fibra di poliestere da 100 gr/mq. Poggiatesta: densità 30 kg/mc. Termofalda di dacron in fibra di poliestere da 450 gr/mq. Braccioli: densità 40 kg/mc. Doppia falda di dacron resinato da 200 gr/mq. Spalliere poggiatesta: densità 23 kg/mc. Termofalda di dacron in fibra di poliestere da 450 gr/mq.

Imbottiture di completamento: densità 21 kg/mc.

RIVESTIMENTO Pelle, tessuto o microfibra. In tessuto, su richiesta, il modello è disponibile anche in versione sfoderabile. Si prega di fare riferimento al listino prezzi appropriato. Per le caratteristiche del rivestimento e della manutenzione vedere relative schede tecniche.

PIEDI In ABS. H = cm 3

NOTE Nella versione relax il modello è dotato esclusivamente di doppio meccanismo elettrico con comandi touch sensor posizionati nello spazio interno tra seduta e bracciolo. Gli elementi centrali relax sono anche essi dotati di comandi touch sensor posti sul fianco della seduta. I comandi possono agire indipendentemente tra di loro variando solo l'inclinazione della testiera oppure permettendo di distendere solo le gambe offrendo infinite possibilità di comfort. Gli elementi relax sono sempre staccati da quelli fissi e vengono agganciati con apposito sistema a baionetta. Nelle versioni fisse senza meccanismo relax in ogni caso è presente il cricchetto manuale nelle testiere.

COVERING Leather, fabric or Microfiber. In fabric, upon request, the model is also available with fully removable covers. Please refer to the appropriate price list. Not removable. Please check covering details for care instructions.

PADDING Seat cushion, armrest, kidney rest and inclining headrest in double density polyurethane foam covered with a layer of goose feathers.

Seat cushion: Polyurethane foam 30kg/m3. Headrest and Kidney rests: Polyurethane foam 23kg/m3. Armrests : Polyurethane foam 30kg/m3.

Frame padding: 21 kg/m3

FRAME Hard wood combined with plywood and particle board.

FEET ABS feet. Height 3 cm

NOTE In the relax version the model is equipped exclusively with a double electric mechanism with touch sensor controls positioned in the internal space between the seat and the armrest. The central elements with recliners are also equipped with touch sensor controls on the side of the seat. The controls can act independently of each other, varying only the inclination of the headrest or allowing to stretch only the legs, offering endless possibilities of comfort. The relax elements are always detached from the fixed ones and are attached with a special bayonet system. In the fixed versions without recliner mechanism, headrest are always equipped with a manual ratchet mechanism.

STRUCTURE En bois combiné avec du bois non traité et biodégradables et des panneaux de fibres de bois dur.

REMBOURRAGE Coussins d'assise, accoudoirs, cale-reins et dossiers appuie-tête inclinables réalisés en polyuréthane expansé à densité différenciée recouvert d'une couche de plumes d'oie.

Coussins d'assise: Polyuréthane expansé 30 Kg/m3. Accoudoirs: Polyuréthane expansé 30 Kg/m3.

Appuie-tête et Cale-reins: Polyuréthane expansé 23 Kg/m3

Rembourrage de complément: densité 21 Kg/m3

RETEVEMENT Cuir, tissu ou microfibre. En tissu, sur demande, le modèle est aussi disponible avec revêtement totalement déhoussable. Merci de vous référer au tarif correspondant. Pour les caractéristiques du revêtement aussi bien que pour l'entretien veuillez consulter les fiches techniques appropriées.

PIEDS En ABS h 3 cm

NOTE Dans la version relax, le modèle est équipé exclusivement d'un double mécanisme électrique avec commandes tactiles positionnées dans l'espace interne entre le siège et l'accoudoir. Les chauffeuses avec relax sont également équipées de commandes tactiles sur le côté du siège. Les commandes peuvent agir indépendamment les unes des autres, ne faisant varier que l'inclinaison de la tête ou vous permettant d'étirer uniquement les jambes, offrant des possibilités infinies de confort. Les éléments avec relax sont toujours détachés des éléments fixes et sont accrochés avec un système spécial à baïonnette. Dans les versions sans mécanique relax, il y a en tout cas un cliquet manuel dans les têtes.

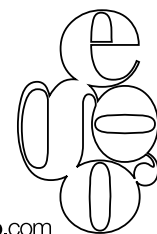
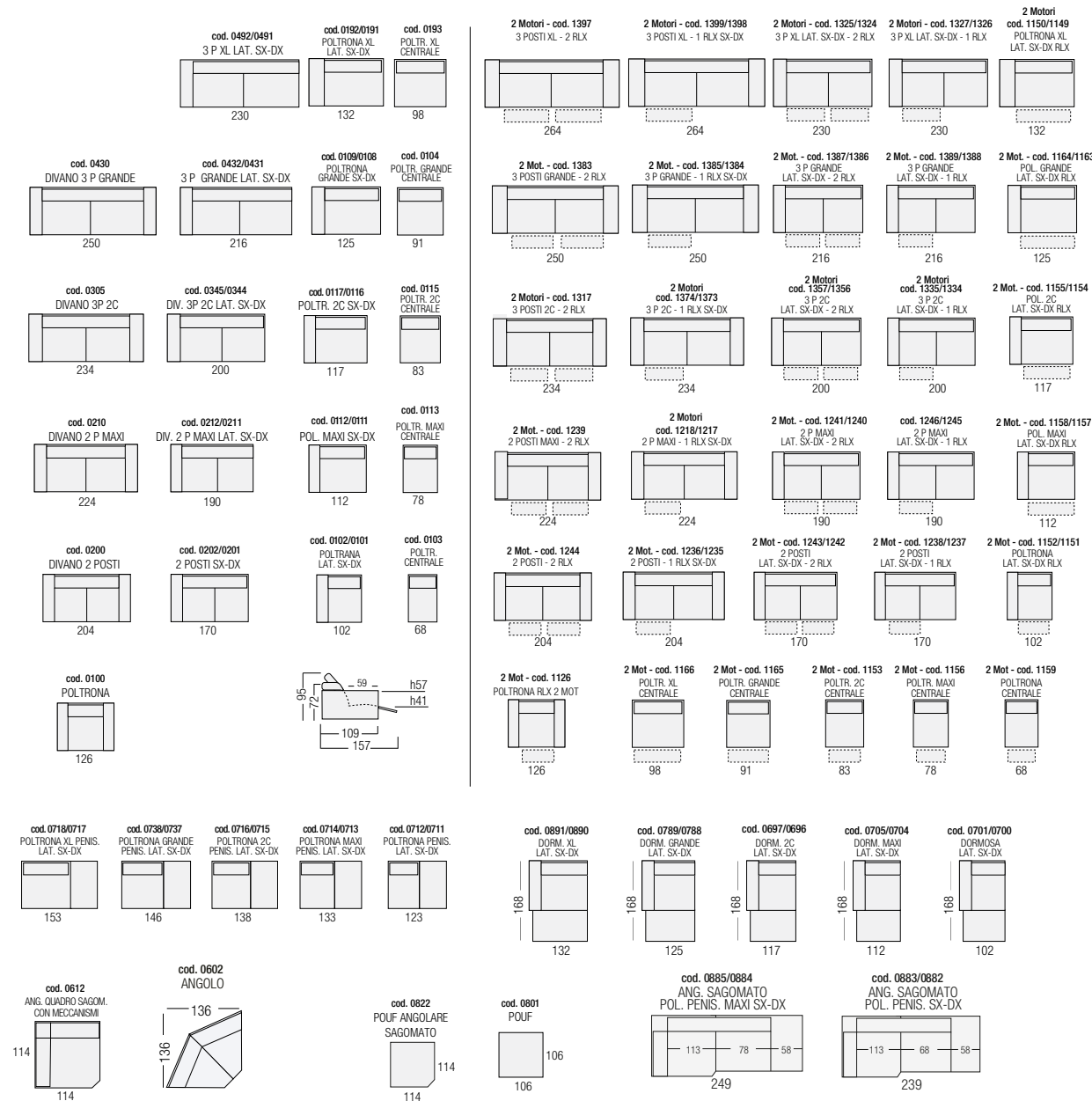

STRUTTURA Realizzata in legno abbinato a particelle di legno grezzo biodegradabile e pannelli di fibra di legno duro.

IMBOTTITURE Cuscini di seduta, braccioli, poggiaresi e spalliere poggiatesta reclinabili sono realizzate in poliuretano espanso a densità differenziate. Tutte le parti sopraelencate sono ricoperte da una termofalda di dacron autoestinguente.

Cuscini di seduta: densità 30 kg/mc. falda di dacron da 350 gr/mq.

Braccioli: densità 30 kg/mc. Termofalda da 200 gr/mq.

Spalliere poggiatesta e poggiaresi: densità 25 kg/mc. Termofalda da 350 gr/mq.

Imbottiture di completamento: densità 21 kg/mc.

RIVESTIMENTO Pelle, tessuto o microfibra. In tessuto, su richiesta, il modello è disponibile anche in versione sfoderabile. Si prega di fare riferimento al listino prezzi appropriato. Per le caratteristiche del rivestimento e della manutenzione vedere relative schede tecniche.

PIEDI Stefanie 1: slitta in metallo verniciato con polveri epossidiche nei colori previsti sulle palette disponibili. H alla base del divano: cm 13

Stefanie 2: piede in metallo verniciato con polveri epossidiche nei colori previsti sulle palette disponibili. H alla base del divano: cm 13

NOTE Nella versione relax il modello è realizzato con meccanismo combinato con movimento schienale poggia piedi, disponibile esclusivamente in versione elettrica con comando touch posizionato sul fianco della seduta corrispondente al lato del bracciolo. L'elemento relax è sempre staccato da quello fisso e viene agganciato con apposito sistema a baionetta. Le sedute centrali con meccanismo relax elettrico sono dotate di comandi touch control posizionati sul fianco della seduta stessa. Gli schienali sono dotati di meccanismo manuale a cricchetto, reclinabili a seconda del comfort desiderato.

COVERING Leather, fabric or Microfiber. In fabric, upon request, the model is also available with fully removable covers. Please refer to the appropriate price list. Not removable. Please check covering details for care instructions.

PADDING Seat cushion, armrests, lumbar supports and backrests-headrests are made in polyurethane foam with varying density. Every part mentioned above is covered by a Dacron layer.

Seat cushions: In polyurethane foam 30 kg/m3. Covered by a dacron layer 350 gr/m2.

Armrests: Polyurethane foam 30 kg/m3. Dacron layer 200 gr/m2.

Backrests-headrests and lumbar supports: Polyurethane foam 25 kg/m3. Dacron layer 350 gr/m2.

Frame padding: Polyurethane foam 21 kg/m3.

FRAME Hardwood combined with plywood and particle board.

FEET Stefanie 1: Glides in metal available in epoxy finish according to its palette. Height to the base of the sofa 13cm.

Stefanie 2: Feet in metal available in epoxy finish according to its palette. Height to the base of the sofa 13cm.

NOTE The relax version comes with electric movements only. Touch sensor controls are placed on the side of the seat cushion next to the armrest. Armless units are also equipped with practical touch sensor buttons placed on the side of the seat cushion. Elements with relax mechanism always delivered separately and connected to the fixed parts by made for purpose bayonet fittings.

Backrests are always equipped with ratchet headrest mechanism allowing to adjust the inclination to the desired comfort position.

STRUCTURE En bois, multiples et particules habillés d'une couche de dacron.

REMBOURRAGE Coussins d'assise, accoudoirs, cale reins et dossiers appui-tête en polyuréthane expansé à densité différenciée. Toutes les parties indiquées sont couvertes par une couche de dacron.

Coussins d'assise: en polyuréthane expansé 30 kg/m3.

Couche en dacron 350 gr/m2.

Accoudoirs: Polyuréthane expansé 30 kg/m3 recouvert avec une couche de dacron 200 gr/m2.

Dossiers appui-tête et cale reins: Polyuréthane expansé 25 kg/m3 recouvert avec une couche de dacron 350 gr/m2.

Rembourrage de complément: densité 21 kg/m3.

REVETEMENT Cuir, tissu ou microfibre. En tissu, sur demande, le modèle est aussi disponible avec revêtement totalement déhoussable. Merci de vous référer au tarif correspondant. Pour les caractéristiques du revêtement aussi bien que pour l'entretien veuillez consulter les fiches techniques appropriées.

PIEDS Stefanie 1: Patins en métal finis avec vernis à poudre couleur dans les finitions prévues dans sa palette. Hauteur à la base du canapé 13 cm

Stefanie 2: Pied en métal fini avec vernis à poudre couleur dans les finitions prévues dans sa palette. Hauteur à la base du canapé 13 cm

NOTE En version relax le modèle est réalisé exclusivement avec relax électrique ayant sa commande touch control située sur la partie latérale de l'assise à côté de l'accoudoir. Les éléments avec relax sont toujours séparés des éléments fixes et reliés avec un système à baionnette.

Les assises centrales ayant mécanique relax sont aussi équipées de commande touch control située sur la partie latérale de l'assise. Les dossiers sont équipés de mécanique manuelle à crémaillère permettant d'atteindre le confort désiré.

VERSIONI CON MECCANISMO RELAX AZIONABILE SOLO ELETTRICAMENTE.

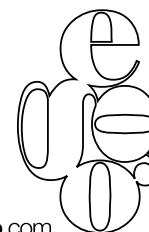
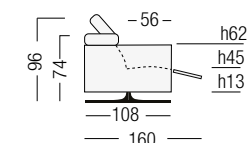
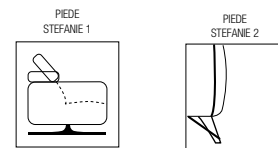
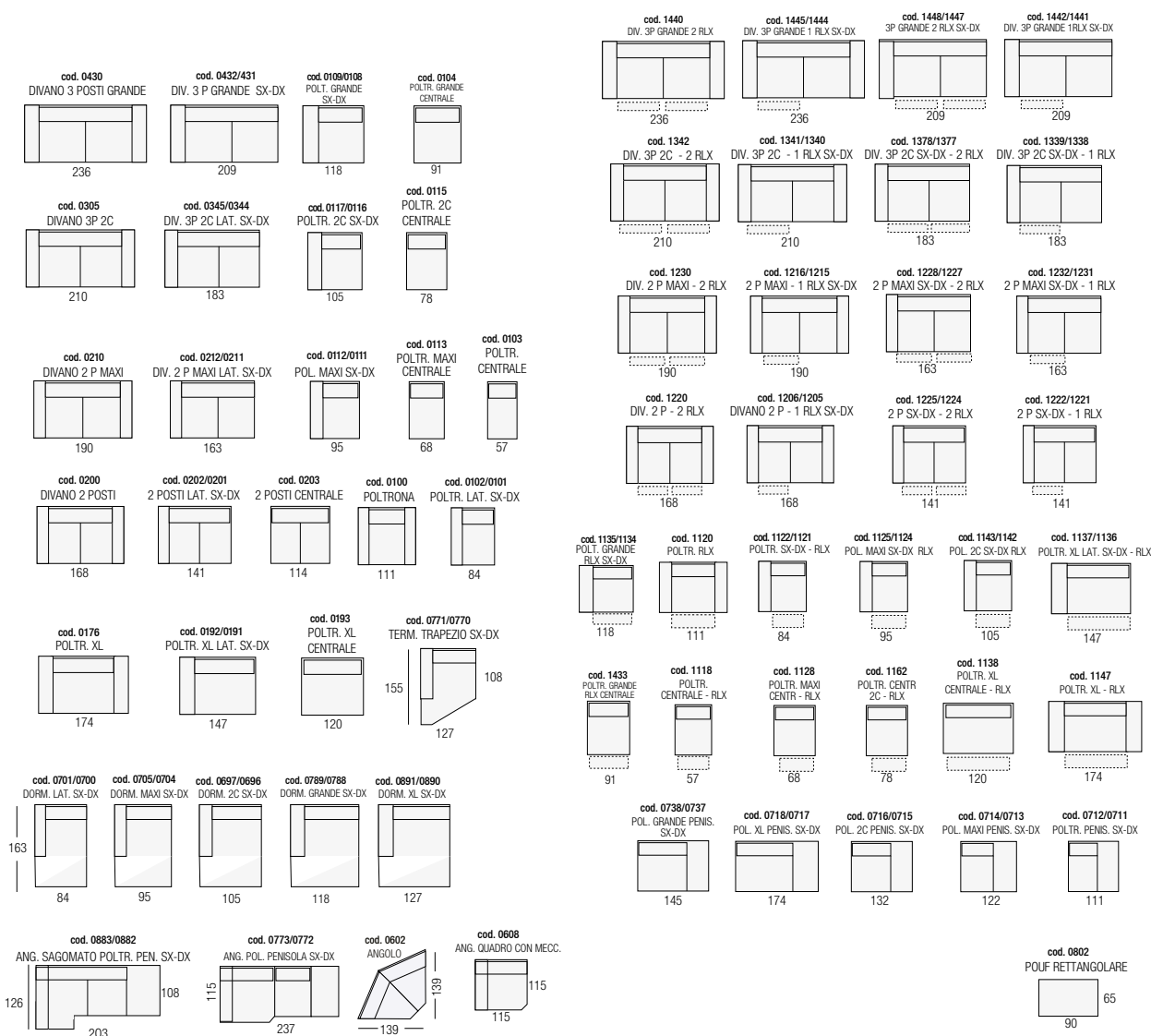

STRUTTURA Realizzata in legno abbinato a particelle di legno grezzo biodegradabile e pannelli di fibra di legno duro. Nella base del divano è integrato un telaio in metallo con funzione portante.

IMBOTTITURE Cuscini di seduta, braccioli, poggiatesta e spalliere poggiatesta reclinabili sono realizzati in poliuretano espanso a densità differenziate. Tutte le parti sopraelencate sono ricoperte da una termofalda di dacron autoestinguente.

Cuscini di seduta: densità 35 kg/mc. Termofalda da 350 gr/mq.

Braccioli: densità 30 kg/mc. Termofalda da 200 gr/mq.

Spalliere e poggiatesta: densità 25 kg/mc. Termofalda di dacron da 350 gr/mq

Cuscinetto poggiatesta: densità 25 kg/mc. Termofalda da 450 gr/mq.

Imbottiture di completamento: densità 21 kg/mc.

RIVESTIMENTO Pelle, tessuto o microfibra. In tessuto, su richiesta, il modello è disponibile anche in versione sfoderabile. Si prega di fare riferimento al listino prezzi appropriato. Per le caratteristiche del rivestimento e della manutenzione vedere relative schede tecniche.

PIEDI In metallo verniciato con colori a base di polveri epossidiche nelle tinte previste sulle palette disponibili. H alla base del divano: cm 20

NOTE Gli schienali del modello sono dotati di un meccanismo manuale che permette facilmente di spostarli in posizione arretrata ottenendo una maggiore profondità di seduta ed offrendo la possibilità di distendere le gambe per un comfort superiore. Le testiere sono corredate di meccanismi manuali a cricchetto, reclinabili a seconda del comfort desiderato.

COVERING Leather, fabric or Microfiber. In fabric, upon request, the model is also available with fully removable covers. Please refer to the appropriate price list. Not removable. Please check covering details for care instructions.

PADDING Seat cushions, armrests, lumbar supports and backrests are made in polyurethane foam with varying density. All of the above parts are covered with a Dacron layer.

Seat cushions: In polyurethane foam 35 kg/m3. Dacron layer 350 gr/m2.

Armrests: In polyurethane foam 30 kg/m3. Dacron layer 200 gr/m2.

Backrests and headrests: In polyurethane foam 25 kg/m3. Dacron layer 350 gr/m2.

Lumbar supports: In polyurethane foam 25 kg/m3. Dacron layer 450 gr/m2.

Frame padding: 21 kg/m3

FRAME Hardwood combined with plywood and particle board. The base is also integrated with a metal frame.

FEET In metal available in epoxy finish according to its palette.

Height to the base of the sofa 20cm.

NOTE The backrests of the model are equipped with a manual mechanism which makes it possible to easily vary the depth of the seating to gain more place for a greater comfort. The headrests are equipped with manual ratchet mechanism, tilting according to the desired comfort.

STRUCTURE En bois, multiples et particules habillés d'une couche de dacron. La structure de la base est intégrée avec un cadre en fer à son intérieur.

REMBOURRAGE Coussins d'assise, accoudoirs, cales reins et dossiers en polyuréthane expansé à double densité. Toutes parties susdites sont recouvertes avec une couche de dacron.

Coussins d'assise : En polyuréthane expansé 35 kg/m3. Dacron 350 gr/m2.

Accoudoirs : En polyuréthane expansé 30 kg/m3. Dacron 200 gr/m2.

Dossiers et têtes: En polyuréthane expansé 25 kg/m3 habillé avec une couche de dacron 350 gr/m2.

Coussin cales reins : En polyuréthane expansé 25 kg/m3 habillé avec une couche de dacron 450 gr/m2.

Rembourrage de complément : densité 21 kg/m3.

REVETEMENT Cuir, tissu ou microfibre. En tissu, sur demande, le modèle est aussi disponible avec revêtement totalement déhoussable. Merci de vous référer au tarif correspondant. Pour les caractéristique du revêtement aussi bien que pour l'entretien veuillez consulter les fiches techniques appropriées.

PIEDS Pied en métal fini avec vernis à poudre couleur dans les finition prévue dans sa palette. Hauteur à la base du canapé 20 cm

NOTE Les dossiers du modèle sont équipés d'un mécanisme manuel qui permet de varier facilement la profondeur de la place assise pour un plus grand confort. Les têtes sont équipées de mécanique manuelles à crémaillère, inclinable selon le confort souhaité.

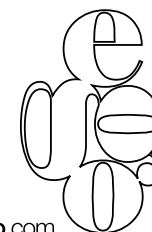
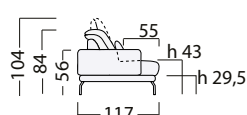
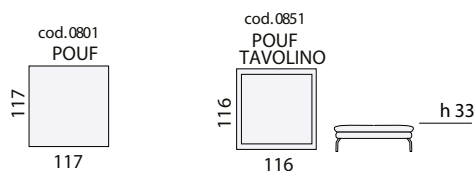
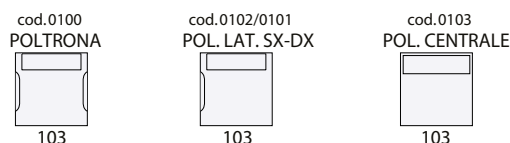
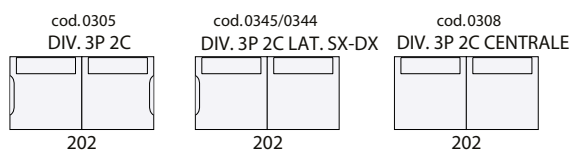

STRUTTURA Realizzata in legno abbinato a particelle di legno grezzo biodegradabile e pannelli di fibra di legno duro. La struttura è corredata di un inserto metallico portante inserito nella base del divano.

IMBOTTITURE Cuscini di seduta, schienali e braccioli sono realizzate in poliuretano espanso a densità differenziate. Tutte le parti sopraelencate sono ricoperte da una termofalda di dacron autoestinguente.

Cuscini di seduta: densità 30 kg/mc. falda di dacron da 350 gr/mq.

Braccioli: parte interna del bracciolo, densità 30 kg/mc. tampone superiore, densità 40 kg/mc. Falda di dacron resinato da 200 gr/mq.

Schienali: densità 30 kg/mc. Falda di dacron resinato da 200 gr/mq.

Imbottiture di completamento: densità 21 kg/mc.

RIVESTIMENTO Pelle, tessuto o microfibra non sfoderabile. Per le caratteristiche del rivestimento e della manutenzione vedere relative schede tecniche.

PIEDI Slitta in metallo verniciato con polveri epossidiche nei colori previsti sulle palette disponibili. H alla base del divano: cm 16

COVERING Leather, fabric or Microfiber. In fabric or microfiber, upon request, the model is also available with fully removable covers. Please refer to the appropriate price list. Not removable. Please check covering details for care instructions.

PADDING Seat cushion, armrests and backrests are made in polyurethane foam with varying density. Every part mentioned above is covered by a Dacron layer.

Seat cushions: In polyurethane foam 30 kg/m3. Covered by a dacron layer 350 gr/m2.

Armrests: internal armrest side in polyurethane foam 30 kg/m3. Upper part in polyurethane foam 40 kg/m3. All covered by a dacron layer 200 gr/m2.

Backrests : Polyurethane foam 30kg/m3. Dacron layer 200 gr/m2.

Frame padding: Polyurethane foam 21 kg/m3.

FRAME Hardwood combined with plywood and particle board. The structure is equipped with a supporting metal insert inserted in the base of the sofa

FEET Glides in metal available in epoxy finish according to its palette. Height to the base of the sofa 16cm.

STRUCTURE En bois, multiples et particules habillés d'une couche de dacron. La structure est équipée d'un insert métallique de support inséré dans la base du canapé

REMBOURRAGE Coussins d'assise, accoudoirs et dossiers en polyuréthane expansé à densité différenciée. Toutes les parties indiquées sont couvertes par une couche de dacron.

Coussins d'assise: en polyuréthane expansé 30 kg/m3. Couche en dacron 350 gr/m2.

Accoudoirs: Partie interne accoudoirs, polyuréthane expansé 30 kg/m3, partie supérieure, densité 40kg/m3 recouvert avec une couche de dacron 200 gr/m2.

Dossiers: Polyuréthane expansé 30 kg/m3 recouvert avec une couche de dacron 200 gr/m2.

Rembourrage de complément : densité 21 kg/m3.

RETEMENT Cuir, tissu ou microfibre non déhoussable. Pour les caractéristiques du revêtement aussi bien que pour l'entretien veuillez consulter les fiches techniques appropriées.

PIEDS Patins en métal finis avec vernis à poudre couleur dans les finitions prévues dans sa palette. Hauteur à la base du canapé 16cm

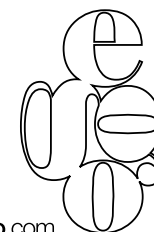
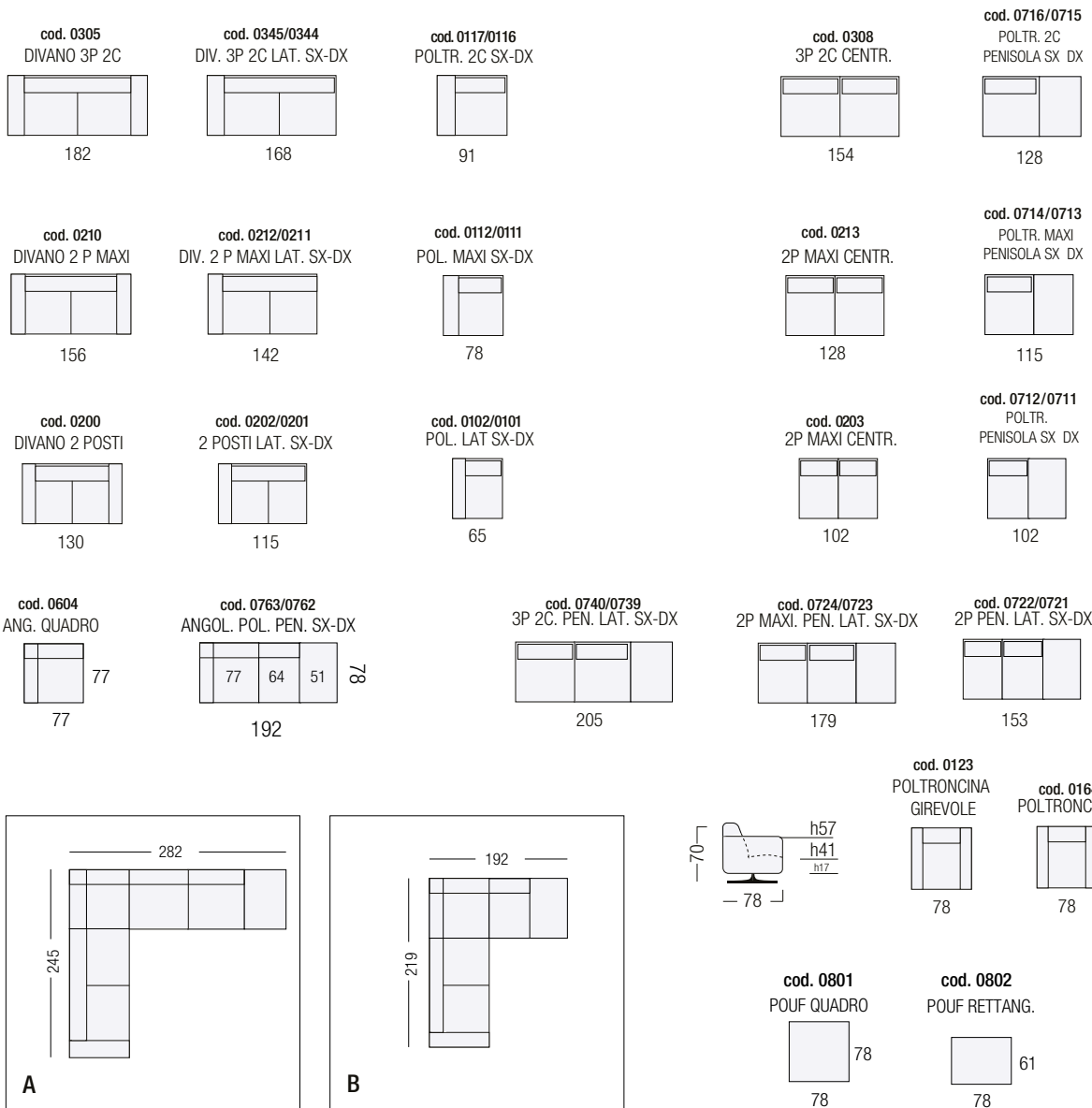

STRUTTURA Realizzata in legno abbinato a particelle di legno grezzo biodegradabile e pannelli di fibra di legno duro.

IMBOTTITURE Cuscini di seduta, braccioli, poggiatesta e spalliere poggiatesta reclinabili sono realizzate in poliuretano espanso a densità differenziate. Tutte le parti sopraelencate sono ricoperte da una termofalda di dacron autoestinguente.

Cuscini di seduta: densità 30 kg/mc. Strato anteriore seduta: densità 35 kg/mc falda di dacron da 200 gr/mq.

Braccioli: densità 30 kg/mc. Termofalda da 200 gr/mq.

Spalliere poggiatesta e poggiatesta: densità 23 kg/mc. Termofalda da 350 gr/mq.

Imbottiture di completamento: densità 21 kg/mc.

RIVESTIMENTO Pelle, tessuto o microfibra. In tessuto, su richiesta, il modello è disponibile anche in versione sfoderabile. Si prega di fare riferimento al listino prezzi appropriato. Per le caratteristiche del rivestimento e della manutenzione vedere relative schede tecniche.

PIEDI Struttura in metallo verniciato con polveri epossidiche nei colori previsti sulle palette disponibili.

H alla base del divano: cm 16

NOTE Gli schienali sono dotati di meccanismo manuale a cricchetto, reclinabili a seconda del comfort desiderato.

COVERING Leather, fabric or Microfiber. In fabric, upon request, the model is also available with fully removable covers. Please refer to the appropriate price list. Not removable. Please check covering details for care instructions.

PADDING Seat cushion, armrests, lumbar supports and backrests-headrests are made in polyurethane foam with varying density. Every part mentioned above is covered by a Dacron layer.

Seat cushions: In polyurethane foam 30 kg/m3. Front part of the seat cushion having 35 kg/m3 density. Covered by a dacron layer 200 gr/m2.

Armrests: Polyurethane foam 30 kg/m3. Dacron layer 200 gr/m2.

Backrests-headrests and lumbar supports: Polyurethane foam 23 kg/m3. Dacron layer 350 gr/m2.

Frame padding: Polyurethane foam 21 kg/m3.

FRAME Hardwood combined with plywood and particle board.

FEET Structure in metal available in epoxy finish according to its palette.

Height to the base of the sofa 16cm.

NOTE Backrests are always equipped with ratchet headrest mechanism allowing to adjust the inclination to the desired comfort position.

STRUCTURE En bois, multiples et particules habillés d'une couche de dacron.

REMBOURRAGE Coussins d'assise, accoudoirs, cale reins et dossiers appui-tête en polyuréthane expansé à densité différenciée. Toutes les parties indiquées sont couvertes par une couche de dacron.

Coussins d'assise: en polyuréthane expansé 30 kg/m3. Partie frontale du coussin en densité 35 kg/m3. Couche en dacron 200 gr/m2.

Accoudoirs: Polyuréthane expansé 30 kg/m3 recouvert avec une couche de dacron 200 gr/m2.

Dossiers appui-tête et cale reins: Polyuréthane expansé 23 kg/m3 recouvert avec une couche de dacron 350 gr/m2.

Rembourrage de complément: densité 21 kg/m3.

REVETEMENT Cuir, tissu ou microfibre. En tissu, sur demande, le modèle est aussi disponible avec revêtement totalement déhoussable. Merci de vous référer au tarif correspondant. Pour les caractéristiques du revêtement aussi bien que pour l'entretien veuillez consulter les fiches techniques appropriées.

PIEDS Structure en métal finis avec vernis à poudre couleur dans les finitions prévues dans sa palette. Hauteur à la base du canapé 16 cm

NOTE Les dossiers sont équipés de mécanique manuelle à crémaillère permettant d'atteindre le confort désiré.

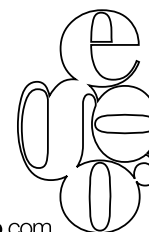
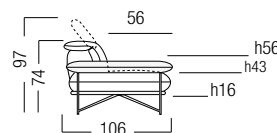
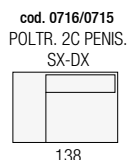
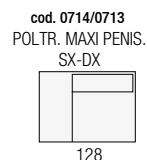
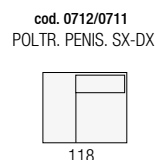
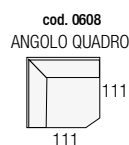
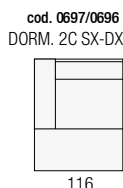
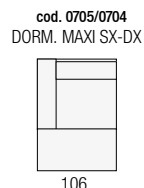
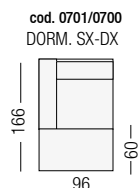
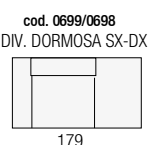
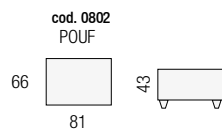
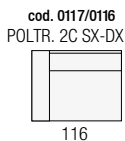
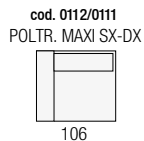
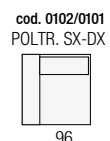
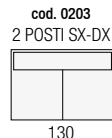
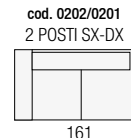
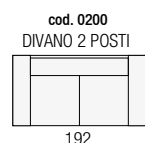
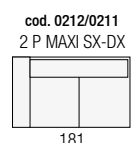
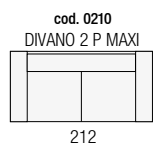
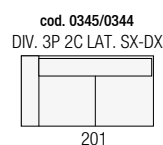
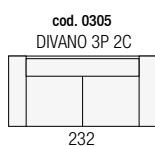

STRUTTURA Realizzata in legno abbinato a particelle di legno grezzo biodegradabile e pannelli di fibra di legno duro..

IMBOTTITURE Cuscini di seduta, braccioli, e schienale sono realizzati in poliuretano espanso a densità differenziate. Tutte le parti sopraelencate sono ricoperte da una termofalda di dacron autoestinguente.

Cuscini di seduta: densità 30 kg/mc. falda di dacron da 200 gr/mq.

Braccioli: densità 21 kg/mc. Termofalda da 200 gr/mq.

Schienale: densità 23 kg/mc. Termofalda da 200 gr/mq.

Imbottiture di completamento: densità 21 kg/mc.

RIVESTIMENTO Pelle, tessuto o microfibra non sfoderabile. Per le caratteristiche del rivestimento e della manutenzione vedere relative schede tecniche.

PIEDI Struttura bracciolo e piedi in metallo verniciato con colori a base di polveri epossidiche nelle tinte previste sulle palette disponibili.

H alla base del divano: cm 12

NOTE Nella versione relax il modello è dotato esclusivamente di meccanismo elettrico con comando posizionato sul lato esterno del bracciolo, mentre le sedute centrali sono dotate di sistema touch control, posizionato tra le sedute. Gli elementi relax sono sempre staccati da quelli fissi e vengono agganciati con apposito sistema a baionetta.

COVERING Leather, fabric or Microfiber. Non removable. Please check covering details for care instructions.

PADDING Seat cushion, armrests and backrests are made in polyurethane foam with varying density. Every part mentioned above is covered by a Dacron layer.

Seat cushions: In polyurethane foam 30 kg/m3. Covered by a dacron layer 200 gr/m2.

Armrests: Polyurethane foam 21 kg/m3. Dacron layer 200 gr/m2.

Backrests: Polyurethane foam 23 kg/m3. Dacron layer 200 gr/m2.

Frame padding: Polyurethane foam 21 kg/m3.

FRAME Hardwood combined with plywood and particle board.

FEET Armrest and feet frame in painted metal with colors based on epoxy powders in the colors provided on the available palette. H at the base of the sofa: 12 cm.

NOTE In the relax version, the model is equipped exclusively with an electric mechanism with control panel positioned on the external side of the armrest, while the central seats are equipped with a touch control system, positioned between the seats. The relax elements are always detached from the fixed ones and are hooked with a special bayonet system.

STRUCTURE En bois, multiples et particules habillés d'une couche de dacron.

REMBOURRAGE Coussins d'assise, accoudoirs et dossiers en polyuréthane expansé à densité différenciée. Toutes les parties indiquées sont couvertes par une couche de dacron.

Coussins d'assise: en polyuréthane expansé 30 kg/m3. Couche en dacron 200 gr/m2.

Accoudoirs: Polyuréthane expansé 21 kg/m3 recouvert avec une couche de dacron 200 gr/m2.

Dossiers: Polyuréthane expansé 23 kg/m3 recouvert avec une couche de dacron 200 gr/m2.

Rembourrage de complément: densité 21 kg/m3.

RELEVEMENT Cuir, tissu ou microfibre non déhoussable. Pour les caractéristiques du revêtement aussi bien que pour l'entretien veuillez consulter les fiches techniques appropriées.

PIEDS Accoudoir et pieds en métal peint avec des couleurs à base de poudres époxy dans les couleurs fournies sur les palettes disponibles. H à la base du canapé: 12 cm

NOTE Dans la version relax, le modèle est équipé exclusivement d'un mécanisme électrique avec contrôle positionné sur le côté extérieur de l'accoudoir, tandis que les chauffeuses sont équipés d'un système de contrôle tactile, positionné entre les sièges. Les éléments relax sont toujours séparés des éléments fixes et sont accrochés avec un système spécial à baionnette.

VERSIONI CON MECCANISMO RELAX AZIONABILE SOLO ELETTRICAMENTE.

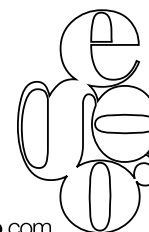
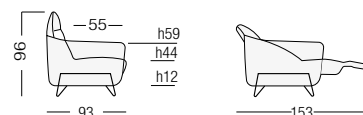
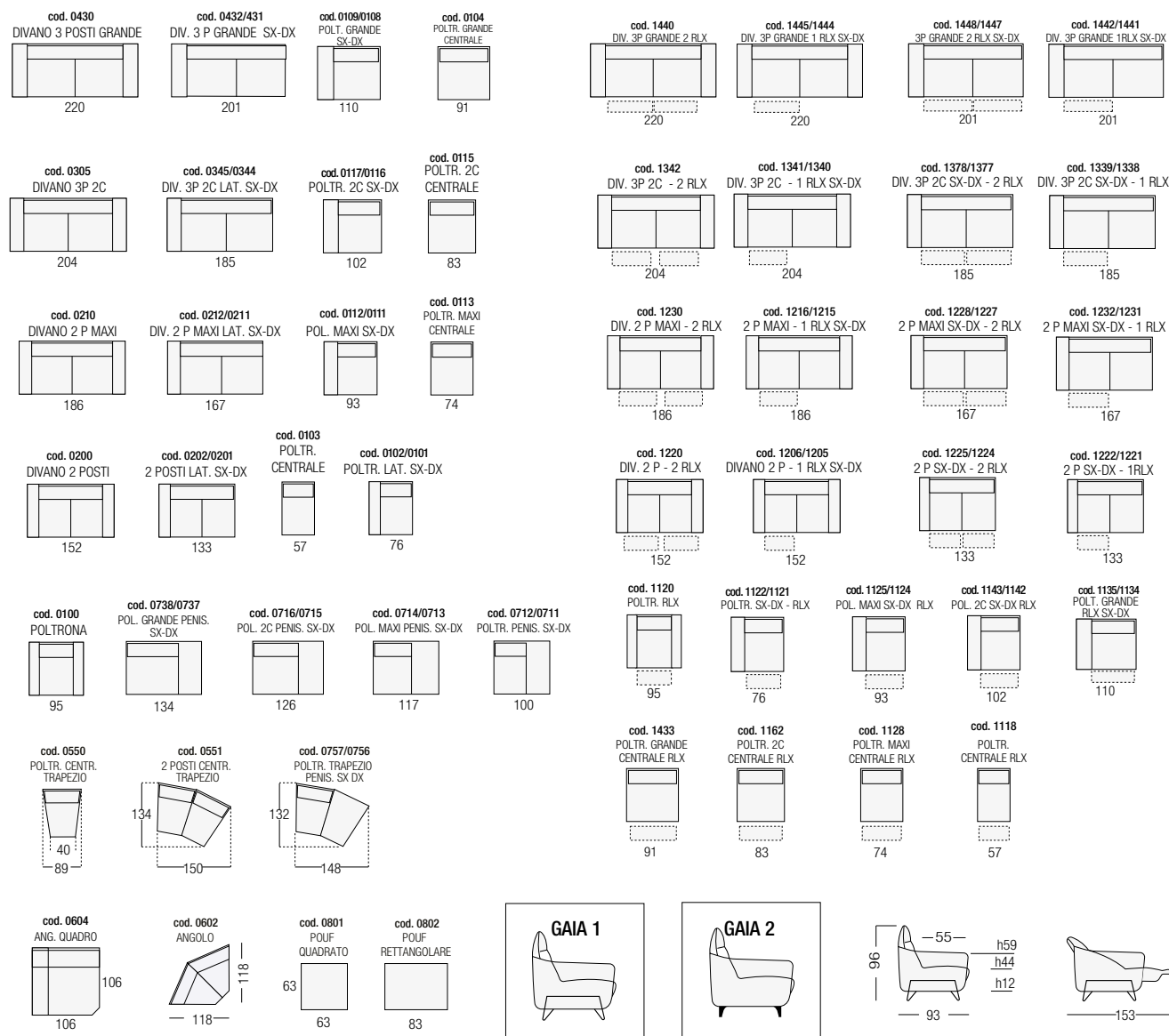

STRUTTURA Realizzata in legno abbinato a particelle di legno grezzo biodegradabile e pannelli di fibra di legno duro.

IMBOTTITURE Cuscini di seduta, braccioli e schienali sono realizzati in poliuretano espanso a densità differenziate. Tutte le parti sopraelencate sono ricoperte da una falda di dacron autoestinguente.

Cuscini di seduta: densità 35 kg/mc. Falda di dacron resinato da 200 gr/mq.

Braccioli: densità 35 kg/mc. Falda di dacron resinato da 200 gr/mq.

Schienali: densità 25 kg/mc. Zona poggiatesta: densità 30 kg/mc. Falda di dacron resinato da 200 gr/mq.

Imbottiture di completamento: densità 21 kg/mc.

Falda di dacron resinato da 200 gr/mq.

RIVESTIMENTO Pelle, tessuto o microfibra. In tessuto, su richiesta, il modello è disponibile anche in versione sfoderabile. Si prega di fare riferimento al listino prezzi appropriato. Per le caratteristiche del rivestimento e della manutenzione vedere relative schede tecniche.

PIEDI In ABS da cm 4

NOTE E' possibile richiedere, solo sulle poltrone laterali, degli speciali meccanismi scorrevoli dotati di motore elettrico, applicati alle sedute, i quali aumentano la profondità di seduta di 25 centimetri e la adattano a diverse esigenze di comfort. Tali meccanismi vengono azionati tramite un pratico telecomando.

COVERING Leather, fabric or Microfiber. In fabric, upon request, the model is also available with fully removable covers. Please refer to the appropriate price list. Not removable. Please check covering details for care instructions.

PADDING Seat cushion, armrests and backrests are made in polyurethane foam with varying density. Every part mentioned above is covered by a Dacron layer.

Seat cushions: Polyurethane foam 35 kg/mc.

Covered by a dacron layer 200 gr/m2.

Armrests: Polyurethane foam 35 kg/m3. Dacron layer 200 gr/m2.

Backrests: Polyurethane foam 25 kg/m3. Dacron layer 200 gr/m2.

Frame padding: Polyurethane foam 21 kg/m3.

FRAME Hardwood combined with plywood and particle board.

FEET ABS feet: cm 4.

NOTE On one arm chairs only, it's possible to request a sliding mechanisms with electric motor, applied to the seats, which increase the seat depth of 25 cm and meets different needs in comfort. These mechanisms are operated via remote control.

STRUCTURE En bois, multiples et particules habillés d'une couche de dacron.

REMBOURRAGE Coussins d'assise, accoudoirs et dossiers en polyuréthane expansé à densité différenciée. Toutes les parties indiquées sont couvertes par une couche de dacron.

Coussins d'assise: en polyuréthane expansé 35 kg/m3. Couche en dacron 200 gr/m2.

Accoudoirs: Polyuréthane expansé 35 kg/m3 recouvert avec une couche de dacron 200 gr/m2.

Dossiers: Polyuréthane expansé 25 kg/m3 recouvert avec une couche de dacron 200 gr/m2.

Rembourrage de complément: densité 21 kg/m3.

REVETEMENT Cuir, tissu ou microfibre. En tissu, sur demande, le modèle est aussi disponible avec revêtement totalement déhoussable. Merci de vous référer au tarif correspondant. Pour les caractéristiques du revêtement aussi bien que pour l'entretien veuillez consulter les fiches techniques appropriées

PIEDS ABS: cm 4

NOTE Vous pouvez demander à fauteuils côté spécial, glissant seulement des mécanismes avec moteur électrique, appliquée aux sièges, qui augmentent la profondeur d'assise de 25 cm et s'adaptent aux différents besoins de confort. Ces mécanismes sont gérés via une télécommande pratique.

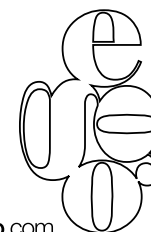
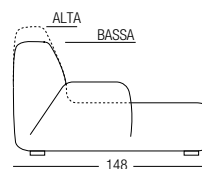
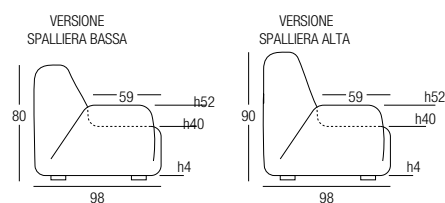
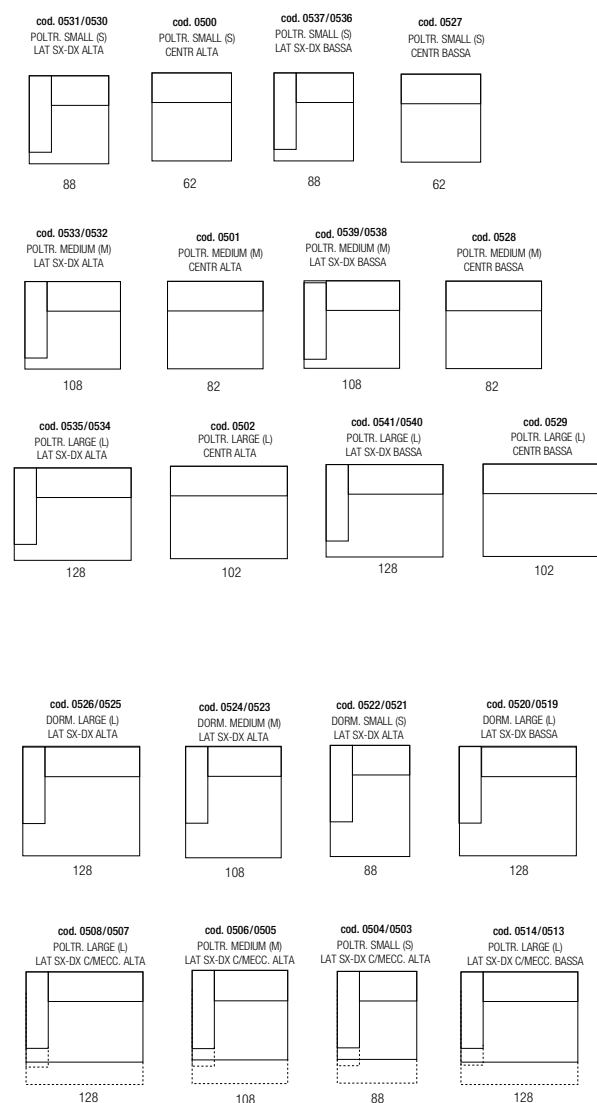

STRUTTURA Realizzata in legno abbinato a particelle di legno grezzo biodegradabile e pannelli di fibra di legno duro.

IMBOTTITURE Cuscini di seduta, braccioli, e schienale sono realizzati in poliuretano espanso a densità differenziate. Tutte le parti sopraelencate sono ricoperte da una termofalda di dacron autoestinguente.

Cuscini di seduta: densità 30 kg/mc. falda di dacron da 200 gr/mq.

Braccioli: densità 30 kg/mc. Termofalda da 200 gr/mq.

Schienale: densità 25 kg/mc. Termofalda da 200 gr/mq.

Imbottiture di completamento: densità 21 kg/mc.

RIVESTIMENTO Pelle, tessuto o microfibra. In tessuto, su richiesta, il modello è disponibile anche in versione sfoderabile. Si prega di fare riferimento al listino prezzi appropriato. Per le caratteristiche del rivestimento e della manutenzione vedere relative schede tecniche.

PIEDI versione 1: base circolare girevole in acciaio. Realizzata nelle finiture metalliche o nelle tinte a base di polveri epossidiche previste sulle palette disponibili.

H base: cm 10

versione 2: In acciaio, nelle finiture metalliche o nelle tinte a base di polveri epossidiche previste sulle palette disponibili. H alla base del divano: cm 12

NOTE Nella versione 1 il modello è realizzato con lo speciale meccanismo manuale GLIDER, il quale viene ancorato alla base girevole e permette un rilassante effetto dondolo. Su richiesta, il modello può essere dotato di una o due comode tasche portariviste, poste sul fianco esterno del bracciolo.

COVERING Leather, fabric or Microfiber. In fabric, upon request, the model is also available with fully removable covers. Please refer to the appropriate price list. Not removable. Please check covering details for care instructions.

PADDING Seat cushion, armrests and backrests are made in polyurethane foam with varying density. Every part mentioned above is covered by a Dacron layer.

Seat cushions: In polyurethane foam 30 kg/m3. Covered by a dacron layer 200 gr/m2.

Armrests: Polyurethane foam 30 kg/m3. Dacron layer 200 gr/m2.

Backrests: Polyurethane foam 25 kg/m3. Dacron layer 200 gr/m2.

Frame padding: Polyurethane foam 21 kg/m3.

FRAME Hardwood combined with plywood and particle board.

FEET version 1: Round stainless steel swivel base. It is available in epoxy finish colours or according to its palette. Height to the base of the sofa 10cm. version 2: Feet in stainless steel available in epoxy finish colors or according to its palette. Height to the base of the sofa 12cm.

NOTE In version 1 the model is made with the special manual GLIDER mechanism, which is anchored to the swivel base and allows a relaxing rocking effect. On request, the model can be equipped with one or two handy magazine pockets placed on the outer side of the armrest.

STRUCTURE En bois, multiples et particules habillés d'une couche de dacron.

REMBOURRAGE Coussins d'assise, accoudoirs et dossiers en polyuréthane expansé à densité différenciée. Toutes les parties indiquées sont couvertes par une couche de dacron.

Coussins d'assise: en polyuréthane expansé 30 kg/m3. Couche en dacron 200 gr/m2.

Accoudoirs: Polyuréthane expansé 30 kg/m3 recouvert avec une couche de dacron 200 gr/m2.

Dossiers: Polyuréthane expansé 25 kg/m3 recouvert avec une couche de dacron 200 gr/m2.

Rembourrage de complément: densité 21 kg/m3.

REVETEMENT Cuir, tissu ou microfibre. En tissu, sur demande, le modèle est aussi disponible avec revêtement totalement déhoussable. Merci de vous référer au tarif correspondant. Pour les caractéristiques du revêtement aussi bien que pour l'entretien veuillez consulter les fiches techniques appropriées

PIEDS version 1: Base ronde pivotante en acier. Disponible dans les couleurs en métal finis avec vernis à poudre ou bien dans les finitions prévues dans sa palette. Hauteur à la base 10 cm

version 2: Pied en acier fini avec vernis à poudre couleur dans les finitions prévues dans sa palette. Hauteur à la base du canapé 12 cm

NOTE Dans la version 1, le modèle est réalisé avec le mécanisme manuel spécial GLIDER, qui est ancré à la base pivotante et permet un effet de balancement relaxant. Sur demande, le modèle peut être équipé d'une ou deux utiles poches porte-magazines, placées sur le côté extérieur de l'accoudoir.

cod. 0179
POLTRONCINA
GIREVOLE - DONDOLO

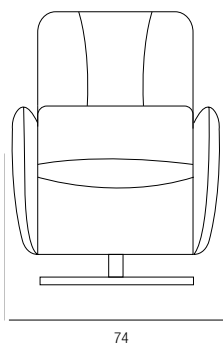

74

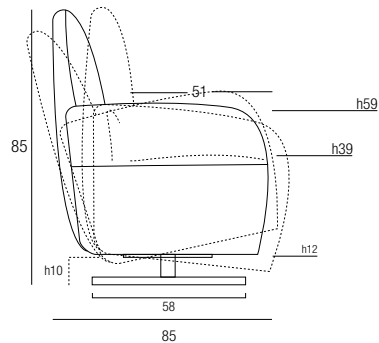

cod. 0823
POUFF
CON BASE

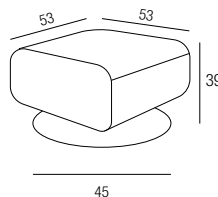

45

cod. 0164
POLTRONCINA
FISSA

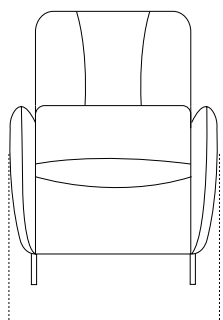

74

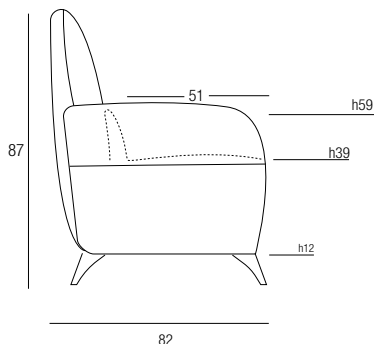

cod. 0801
POUFF
QUADRATO

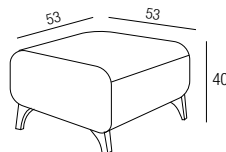

40

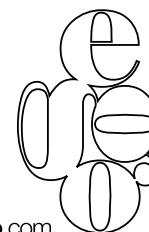

STRUTTURA Realizzata in legno abbinato a particelle di legno grezzo biodegradabile e pannelli di fibra di legno duro.

IMBOTTITURE Cuscini di seduta, braccioli, e schienale sono realizzati in poliuretano espanso a densità differenziate. Tutte le parti sopraelencate sono ricoperte da una termofalda di dacron autoestinguente.

Cuscini di seduta: densità 30 kg/mc. falda di dacron da 200 gr/mq.

Braccioli: densità 30 kg/mc. Termofalda da 200 gr/mq.

Schienale: densità 25 kg/mc. Termofalda da 200 gr/mq.

Imbottiture di completamento: densità 21 kg/mc.

RIVESTIMENTO Pelle, tessuto o microfibra. In tessuto o microfibra, su richiesta, il modello è disponibile anche in versione sfoderabile. Si prega di fare riferimento al listino prezzi appropriato. Per le caratteristiche del rivestimento e della manutenzione vedere relative schede tecniche.

PIEDI versione 1: base circolare girevole in acciaio. Realizzata nelle finiture metalliche o nelle tinte a base di polveri epossidiche previste sulle palette disponibili.

H base: cm 10

versione 2: In acciaio, nelle finiture metalliche o nelle tinte a base di polveri epossidiche previste sulle palette disponibili. H alla base del divano: cm 12

NOTE Nella versione 1 il modello è realizzato con lo speciale meccanismo manuale GLIDER, il quale viene ancorato alla base girevole e permette un rilassante effetto dondolo.

COVERING Leather, fabric or Microfiber. In fabric or microfiber, upon request, the model is also available with fully removable covers. Please refer to the appropriate price list. Not removable. Please check covering details for care instructions.

PADDING Seat cushion, armrests and backrests are made in polyurethane foam with varying density. Every part mentioned above is covered by a Dacron layer.

Seat cushions: In polyurethane foam 30 kg/m3. Covered by a dacron layer 200 gr/m2.

Armrests: Polyurethane foam 30 kg/m3. Dacron layer 200 gr/m2.

Backrests: Polyurethane foam 25 kg/m3. Dacron layer 200 gr/m2.

Frame padding: Polyurethane foam 21 kg/m3.

FRAME Hardwood combined with plywood and particle board.

FEET version 1: Round stainless steel swivel base. It is available in epoxy finish colours or according to its palette. Height to the base of the sofa 10cm. version 2: Feet in stainless steel available in epoxy finish colors or according to its palette. Height to the base of the sofa 12cm.

NOTE In version 1 the model is made with the special manual GLIDER mechanism, which is anchored to the swivel base and allows a relaxing rocking effect.

STRUCTURE En bois, multiples et particules habillés d'une couche de dacron.

REMBOURRAGE Coussins d'assise, accoudoirs et dossiers en polyuréthane expansé à densité différenciée. Toutes les parties indiquées sont couvertes par une couche de dacron.

Coussins d'assise: en polyuréthane expansé 30 kg/m3. Couche en dacron 200 gr/m2.

Accoudoirs: Polyuréthane expansé 30 kg/m3 recouvert avec une couche de dacron 200 gr/m2.

Dossiers: Polyuréthane expansé 25 kg/m3 recouvert avec une couche de dacron 200 gr/m2.

Rembourrage de complément: densité 21 kg/m3.

RETEMENT Cuir, tissu ou microfibre. En tissu ou microfibre, sur demande, le modèle est aussi disponible avec revêtement totalement déhoussable. Merci de vous référer au tarif correspondant. Pour les caractéristiques du revêtement aussi bien que pour l'entretien veuillez consulter les fiches techniques appropriées.

PIEDS version 1: Base ronde pivotante en acier. Disponible dans les couleurs en métal finis avec vernis à poudre ou bien dans les finitions prévues dans sa palette. Hauteur à la base 10 cm

version 2: Pied en acier fini avec vernis à poudre couleur dans les finitions prévues dans sa palette. Hauteur à la base du canapé 12 cm

NOTE Dans la version 1, le modèle est réalisé avec le mécanisme manuel spécial GLIDER, qui est ancré à la base pivotante et permet un effet de balancement relaxant.

cod. 0179
POLTRONCINA
GIREVOLE - DONDOLO

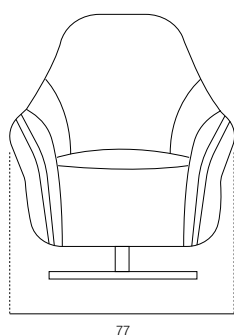

77

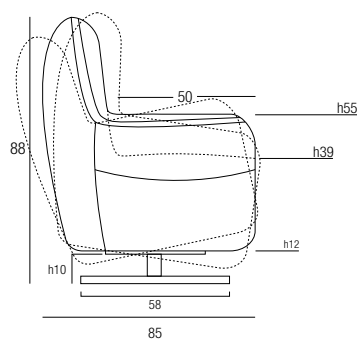

cod. 0823
POUFF
CON BASE

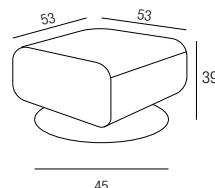

cod. 0164
POLTRONCINA
FISSA

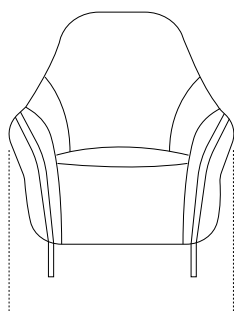

77

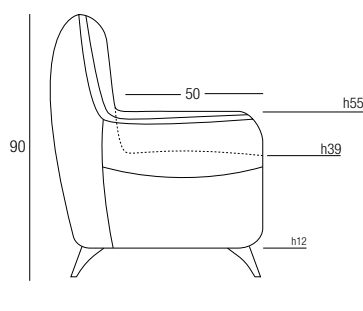

cod. 0801
POUFF
QUADRATO

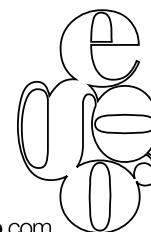
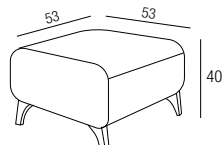

STRUTTURA In acciaio. La struttura dei braccioli è realizzata con pannelli in legno abbinato a particelle di legno grezzo biodegradabile e pannelli di fibra di legno duro.

IMBOTTITURE Cuscino di seduta, braccioli e schienale sono realizzati in poliuretano espanso a densità differenziata. Tutte le parti sopraelencate sono ricoperte da una termofalda di dacron autoestinguente da 200 gr/mq.

Cuscino di seduta: densità 35 kg/mc.

Braccioli : densità 30 kg/mc.

Schienale: densità 23 kg/mc.

Imbottiture di completamento: densità 21 kg/mc.

RIVESTIMENTO Pelle, tessuto o microfibra non sfoderabile. Per le caratteristiche del rivestimento e della manutenzione vedere relative schede tecniche.

PIEDI Base circolare girevole in acciaio. Realizzata nelle finiture metalliche o nelle tinte a base di polveri epossidiche previste sulle palette disponibili. H base: cm 16

NOTE La struttura della poltrona è costituita da un telaio in acciaio con molle greche sulla seduta, dotato di due motori elettrici che agiscono indipendentemente l'uno dall'altro ed azionano il movimento dello schienale e della seduta.

I comandi sono posti sul fianco interno del bracciolo e comprendono i tasti di apertura/chiusura della seduta e dello schienale. I meccanismi operano grazie a batterie al litio a lunga durata ricaricabili che ne permettono l'utilizzo anche lontano da una presa di corrente. La parte superiore dello schienale si reclinava automaticamente in avanti in sequenza contemporanea con il movimento di abbassamento dello schienale. Tale inclinazione rende più confortevole la lettura o la visione della TV.

STRUCTURE Stainless Steel. The armrest structure is made in hardwood combined with plywood and particle board.

COVERING Leather, fabric or non-removable microfiber. For the covering characteristics and maintenance instructions see relative data sheet.

PADDING Seat cushion, armrests and backrest are made of polyurethane foam with varying densities. All parts listed are covered with an acrylic layer of self-extinguishing dacron from 200 gr / mq.

Seat cushion: density 35 kg / mc.

Armrests: density 30 kg / mc.

Backrest: density 23 kg / mc.

Frame Padding: density 21 kg / mc.

FRAME Hardwood combined with plywood and particle board.

FEET Round polished steel swivel base. Available in different finishes or in the epoxy powder finish colors available in the palette. H: 16 cm

NOTE The armchair structure is constituted by a steel frame with no sags springs on the seat, equipped with two electric motors which act independently of one another and actuate the movement of the backrest and the seat. The controls are located on the inner side of the armrest and include the opening / closing buttons for the seat and backrest .

The mechanisms operate thanks to rechargeable long-life lithium battery that allow its use also away from a power outlet. The upper part of the backrest reclines forward automatically, in sequence with the backrest movement. This further headrest inclination makes reading or watching TV more comfortable.

STRUCTURE Acier Inoxydable. Les accoudoirs sont en bois, multiplies et particules habillés d'une couche de dacron.

REMBOURRAGE Coussin d'assise, accoudoirs et dossier sont en mousse de polyuréthane à densités différenciées. Toutes les pièces énumérées sont recouvertes d'une couche acrylique de dacron anti-feu de 200 gr / mq.

Coussin d'assise: densité 35 kg / mc.

Accoudoir: densité 30 kg / mc.

Dossier: densité 23 kg / mc.

Rembourrage de complément: densité 21 kg / mc.

REVETEMENT Cuir, tissu ou microfibre non déhoussable. Pour les caractéristiques du revêtement et l'entretien voir la fiche de données relatives.

PIEDS Base ronde pivotante en acier poli. Aussi disponible dans les finitions métalliques ou dans les teintes à vernis à poudre disponibles dans la palette. H: 16 cm

NOTE La structure du fauteuil est constituée par un double cadre d'acier nommé « frame in frame » ayant des ressorts sous l'assise, équipé de deux moteurs électriques qui agissent indépendamment l'un de l'autre et actionnent le mouvement du dossier et de l'assise. Le clavier de fonctionnement est situé sur le côté interne de l'accoudoir et comprend les touches d'ouverture / fermeture du siège et du dossier, aussi bien que de la touche de remise à zéro qui remet le fauteuil dans sa position initiale. Les touches s'allument pendant le fonctionnement. Les mécanismes fonctionnent grâce à des batteries rechargeables au lithium à longue durée qui permettent son utilisation aussi loin d'une prise de courant.

cod. 1170

POLTRONCINA GIREVOLE
2 MOT.

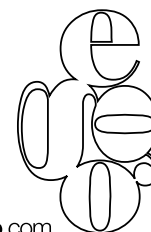
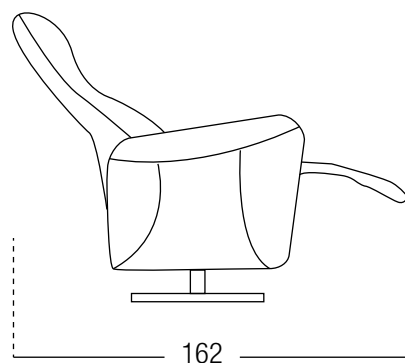
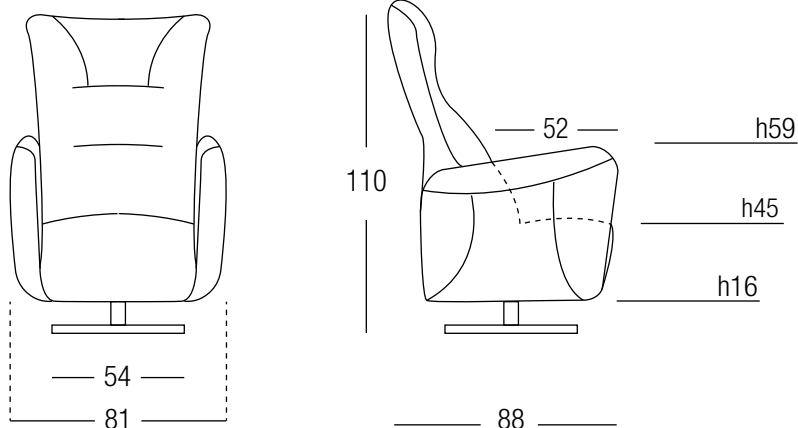

STRUTTURA Realizzata in legno abbinato a particelle di legno grezzo biodegradabile e pannelli di fibra di legno duro.

IMBOTTITURE Cuscini di seduta, braccioli, poggiatesta e spalliere poggiatesta reclinabili sono realizzate in poliuretano espanso a densità differenziate. Tutte le parti sopraelencate sono ricoperte da una termofalda di dacron autoestinguente. Cuscini di seduta: densità 30 kg/mc. falda di dacron da 200 gr/mq. Braccioli: densità 30 kg/mc. Termofalda da 350 gr/mq. Spalliere poggiatesta e poggiatesta: densità 25 kg/mc. Termofalda da 350 gr/mq. Imbottiture di completamento: densità 21 kg/mc.

RIVESTIMENTO Pelle o microfibra non sfoderabile. Per le caratteristiche del rivestimento e della manutenzione vedere relative schede tecniche.

PIEDI In metallo nei colori previsti sulle palette disponibili. H alla base del divano: cm 13

NOTE Nella versione relax il modello è dotato esclusivamente di meccanismo elettrico con comando posizionato sul lato esterno del divano, mentre le sedute centrali sono dotate di pulsanti touch control. Gli elementi relax sono sempre staccati da quelli fissi e vengono agganciati con apposito sistema a baionetta. Nelle versioni fisse senza meccanismo relax in ogni caso è presente il cricchetto manuale nelle testiere.

FRAME Hardwood combined with plywood and particle board.

PADDING Seat cushion, armrests, lumbar supports and backrests-headrests are made in polyurethane foam with varying density. Every part mentioned above is covered by a Dacron layer.

Seat cushions: In polyurethane foam 30 kg/m3. Covered by a dacron layer 200 gr/m2. Armrests: Polyurethane foam 30 kg/m3. Dacron layer 350 gr/m2.

Backrests-headrests and lumbar supports: Polyurethane foam 25 kg/m3. Dacron layer 350 gr/m2.

Frame padding: Polyurethane foam 21 kg/m3.

COVERING Leather or microfiber. Not removable. Please check covering details for care instructions.

FEET In metal in the optional colours available in its palette. Height to the base of the sofa 13cm.

NOTE The relax version comes with electric movements only. Controls are placed on the armrest side, whilst armless units are equipped with practical touch sensor buttons placed on the side of the seat cushion itself. Elements with relax mechanism always delivered separately and connected to the fixed parts by made for purpose bayonet fittings. Fixed versions are always equipped with mechanical headrests mechanism.

STRUCTURE En bois, multiples et particules habillés d'une couche de dacron.

REMBOURRAGE Coussins d'assise, accoudoirs, cale reins et dossiers appui-tête en polyuréthane expansé à densité différenciée. Toutes les parties indiquées sont couvertes par une couche de dacron.

Coussins d'assise: en polyuréthane expansé 30 kg/m3. Couche en dacron 200 gr/m2. Accoudoirs: Polyuréthane expansé 30 kg/m3 recouvert avec une couche de dacron 350 gr/m2.

Dossiers appui-tête et cale reins: Polyuréthane expansé 25 kg/m3 recouvert avec une couche de dacron 350 gr/m2.

Rembourrage de complément: densité 21 kg/m3.

RETEMENT Cuir ou microfibre non déhoussable. Pour les caractéristiques du revêtement aussi bien que pour l'entretien veuillez consulter les fiches techniques appropriées.

PIEDS En métal dans les finitions prévues dans sa palette. Hauteur à la base du canapé 13 cm

NOTE En version relax le modèle est réalisé exclusivement avec relax électrique ayant sa commande située sur la partie latérale extérieure de l'accoudoir, alors que les assises centrales sont équipées avec bouton Touch control placé sur le côté de l'assise. Les éléments avec relax sont toujours séparés des éléments fixes et reliés avec un système à baïonnette. Les versions fixes sans relax sont en tout cas toujours équipées avec mécanique à crémaillère des appui tête.

VERSIONI CON MECCANISMO RELAX AZIONABILE SOLO ELETTRICAMENTE.

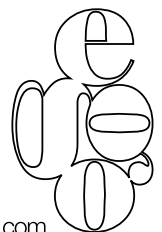
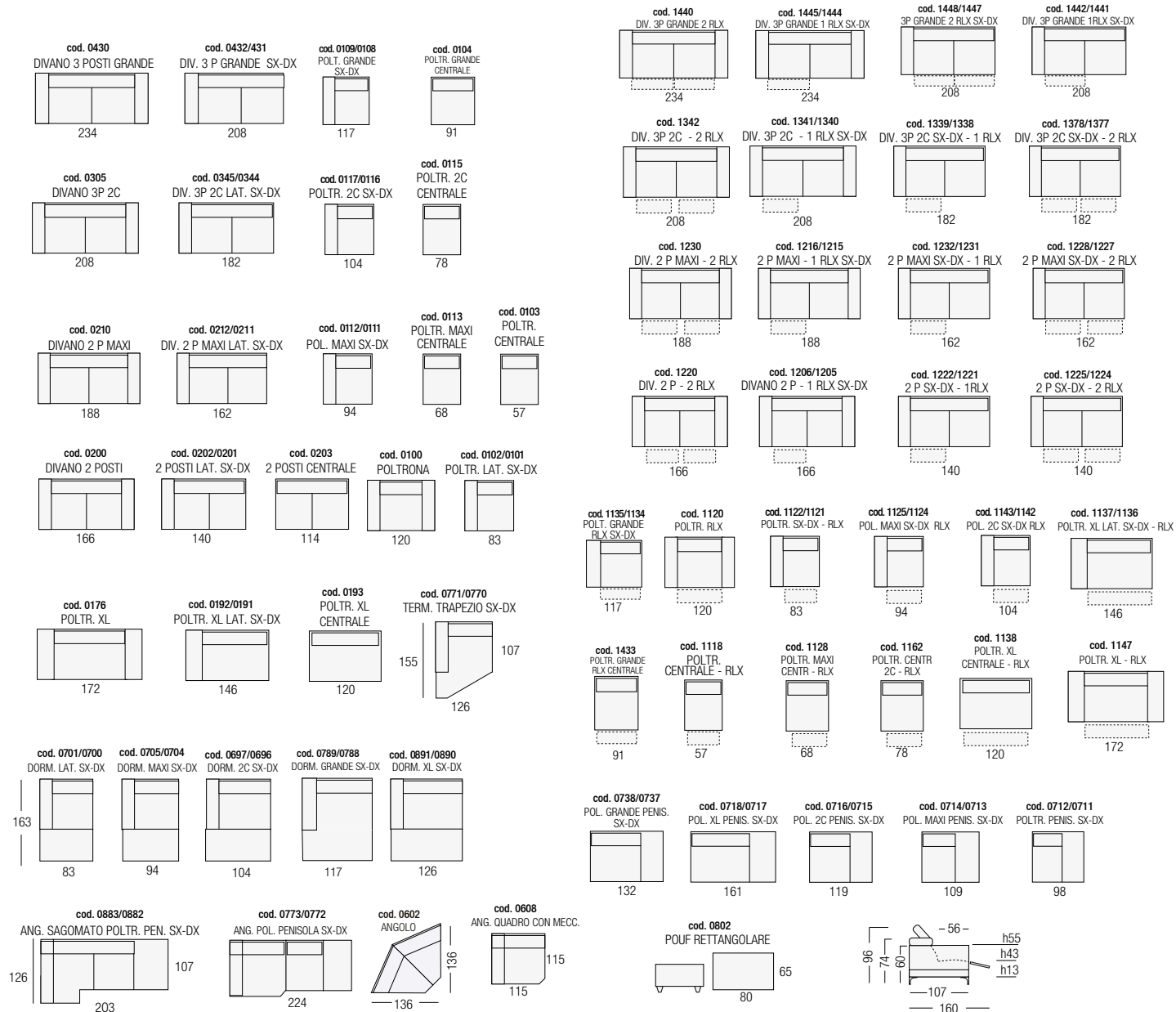

STRUTTURA Realizzata in legno abbinato a particelle di legno grezzo biodegradabile e pannelli di fibra di legno duro.

IMBOTTITURE Braccioli, poggiatesta e spalliere poggiatesta reclinabili sono realizzate in poliuretano espanso a densità differenziate. Tutte le parti sopraelencate sono ricoperte da una termofalda di dacron autoestinguente.

Cuscini di seduta: densità 30 kg/mc. Falda in dacron resinato da 200 gr/mq.

Braccioli: densità 30 kg/mc. Termofalda da 350 gr/mq.

Poggiatesta: densità 23 kg/mc. Termofalda da 350 gr/mq.

Spalliere poggiatesta: densità 23 kg/mc. Termofalda da 350 gr/mq.

Imbottiture di completamento: densità 21 kg/mc.

RIVESTIMENTO Pelle o microfibra non sfoderabile. Per le caratteristiche del rivestimento e della manutenzione vedere relative schede tecniche.

PIEDI In metallo nei colori previsti sulle palette disponibili. H alla base del divano: cm 13

NOTE Gli schienali ed i braccioli sono dotati di meccanismo manuale a cricchetto, reclinabili a seconda del comfort desiderato.

I braccioli, grazie agli speciali cricchetti a frizione di cui sono dotati, possono essere riportati in posizione di chiusura semplicemente premendo verso il basso.

FRAME Hardwood combined with plywood and particle board.

PADDING Armrests, lumbar supports, backrests and headrests are made in polyurethane foam with varying density. All of the above parts are covered with a Dacron layer.

Seat cushions: In Polyurethane foam 30 kg/m3 covered in dacron 200 gr/m2.

Armrests: Polyurethane foam 30 kg/m3 covered in dacron 350 gr/m2.

Lumbar supports: Polyurethane foam 23 kg/m3 covered in dacron 350 gr/m2.

Back cushions and headrests: 23 kg/m3. Dacron layer 350 gr/m2.

Frame padding: 21 kg/m3

COVERING Leather or microfiber. Not removable. Please check covering details for care instructions.

FEET In metal in the optional colours available in its palette. Height to the base of the sofa 13cm.

NOTE Headrests and armrests are equipped with manual adjustable mechanism that allows you to find the desired comfort position.

Armrests are equipped with a special friction mechanism that allows you bring them back to the starting position by simply pushing them down.

STRUCTURE En bois, multiples et particules habillés d'une couche de dacron.

REMBOURRAGE Accoudoirs, cales-reins, dossiers et appuie-tête en polyuréthane expansé à double densité. Toutes les parties susdites sont recouvertes avec une couche de dacron.

Coussins d'assise : Polyuréthane expansé 30 kg/m3 recouvert en dacron 200 gr/m2.

Accoudoirs: Polyuréthane expansé 30 kg/m3 recouvert en dacron 350 gr/m2.

Cales-reins: Polyuréthane expansé 23 kg/m3 recouvert en dacron 350 gr/m2.

Dossiers et appuie-tête : 23 kg/m3 recouvert en dacron 350/m2.

Rembourrage de complément : densité 21 kg/m3.

REVETEMENT Cuir ou microfibre non déhoussable. Pour les caractéristique du revêtement aussi bien que pour l'entretien veuillez consulter les fiches techniques appropriées.

PIEDS En métal dans les finition prévue dans sa palette. Hauteur à la base du canapé 13 cm

NOTE Les appuie-têtes et les accoudoirs sont équipés d'une mécanique manuelle qui permet de trouver la position désirée.

Les accoudoirs, grâce à la mécanique spéciale à friction, peuvent revenir à la position fermée simplement en appuyant dessus.

BRACCIOLI CON CRICCHETTO

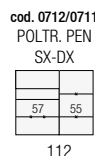
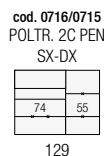
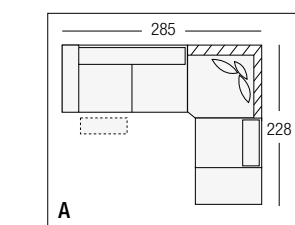
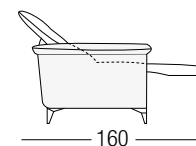
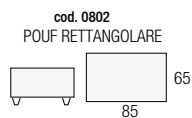
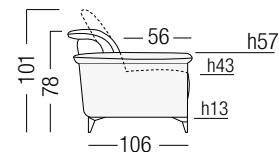
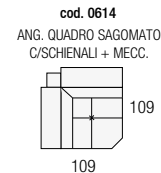
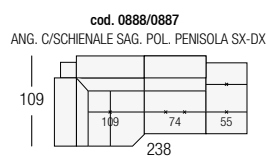
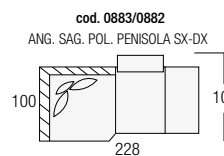
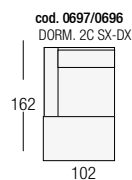
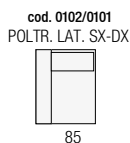
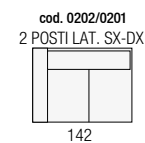
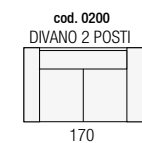
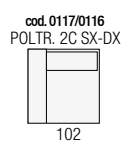
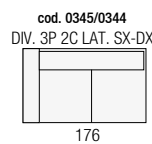
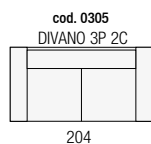
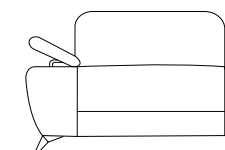

VERSIONI CON MECCANISMO RELAX AZIONABILE SOLO ELETTRICAMENTE.

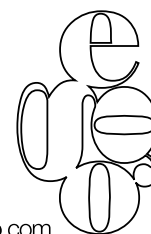
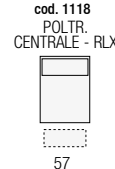
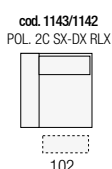
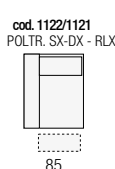
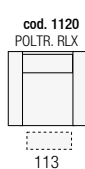
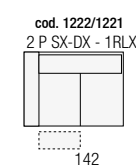
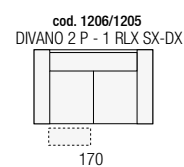
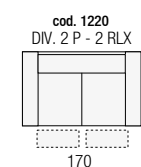
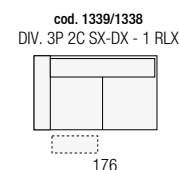
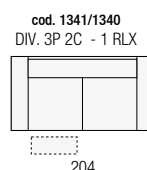
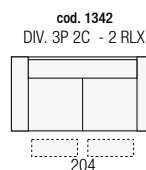

TAVOLINI MAC

Rev. 05/2018

STRUTTURA In metallo da mm 4 con finitura in vernici a polvere epossidica, nei colori bianco perla opaco, nero graphite opaco, marrone anticato opaco, rosso opaco, bordò opaco o blu opaco.

FRAME metal feet mm 4 in epoxy powder finish, colour pearl white, black graphite, dark brown, red, blue or burgundy.

STRUCTURE en métal de 4 mm, verni en poudre époxy disponible dans les finitions suivantes: graphite sablé, marron sablé, blanc perle, rouge, bordeaux et bleu mat.

COD. TAVO0039
TAVOLINO BIG MAC

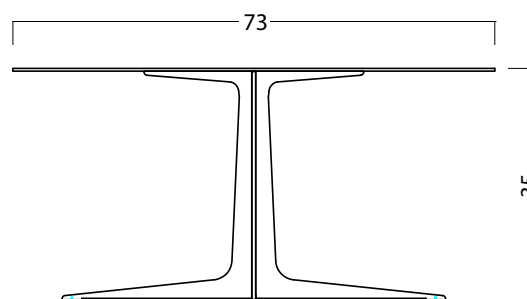
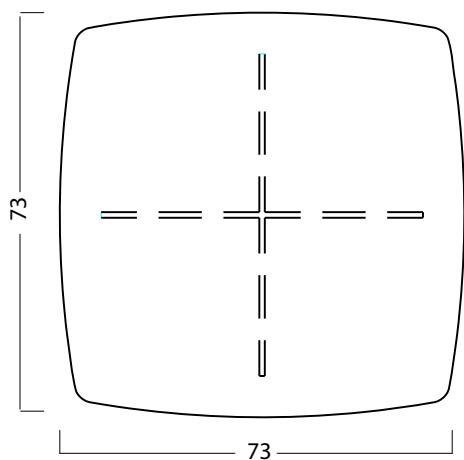

COD. TAVO0040
TAVOLINO SMALL MAC

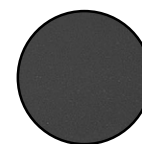
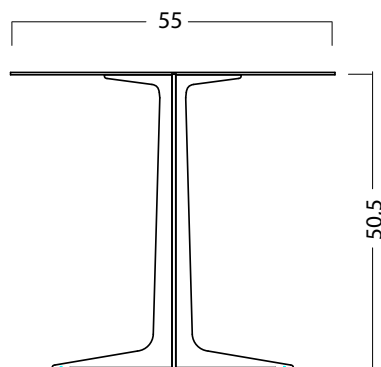
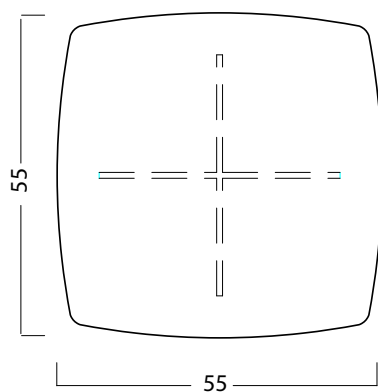

graphite

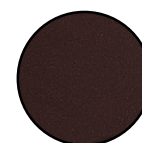

brown

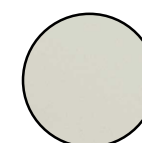

white
1013

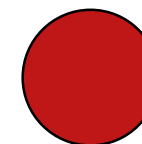

red
3003

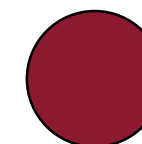

bordeaux
3005

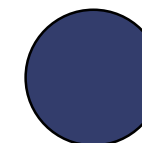

blu
5001

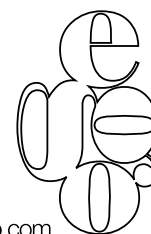

STRUTTURA In legno massello di frassino disponibile nelle tinte rovere naturale o noce canaletto. Tavolino in metallo 4 mm in vernice a polvere epossidica colore graphite nero opaco.

NOTE Nella versione in tinta noce canaletto, il cavo della lampada è di colore azzurro. Nella versione in rovere naturale, il cavo è di colore bordò.

FRAME Structure in solid wood ash, available in two colours, natural oak or Canaletto walnut. Metal table mm 4 in epoxy powder finish, colour black graphite.

NOTES in the canaletto walnut version, the lamp wire is blue. In the natural oak version, the wire is burgundy.

STRUCTURE Structure en frêne massif, disponible en deux couleurs, en chêne naturel ou en noyer de bois. Table en métal de 4 mm, verni en poudre époxy graphite sablé.

NOTES sur la structure en noyer de bois, le câble de la lampe est en bleu. Dans la version en chêne naturelle, le câble est de couleur bordeaux.

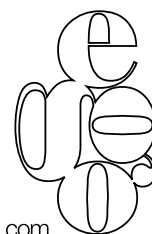
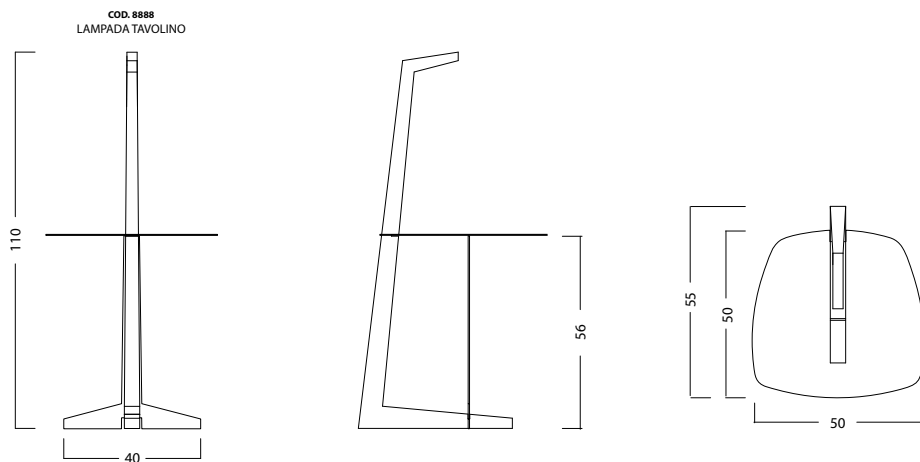

MORFEO

Rev. 05/2018

STRUTTURA Tubolare in metallo verniciato in vernice a polvere epossidica, disponibile nelle tinte rosso, bianco perla e nero grafite.

RIVESTIMENTO paralume in tessuto, disponibile nelle tinte bianco sabbia e grigio antracite.

FRAME Tubular metal lacquered in epoxy powder paint, available in the colours red, Pearl White and graphite black.

COVERING fabric shade, available in dark gray or sandy white.

STRUCTURE tubulaire verni en poudre époxy disponible en graphite sablé, rouge et blanche.

REVELEMENT Abat-jour tissu doublure, disponible en sable blanc et gris anthracite.

cod.8888
LAMPADA
MORFEO

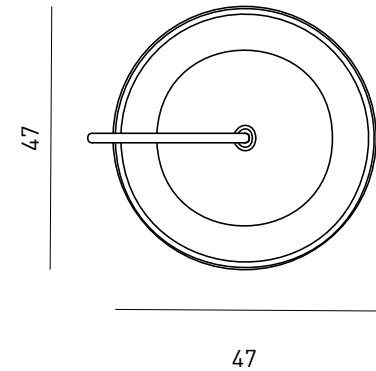
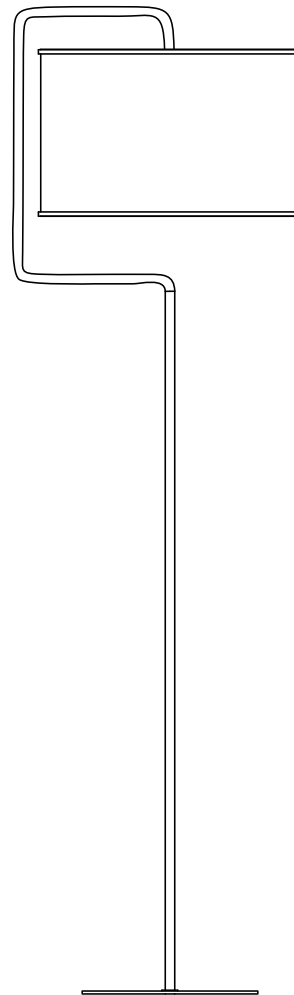
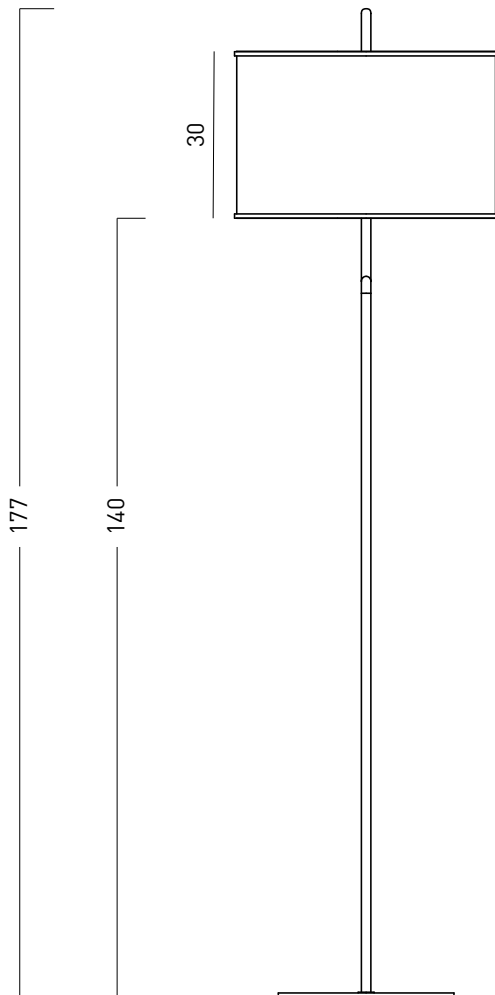

STRUTTURA TUBOLARE / TUBULAR / TUBULARE



graphite

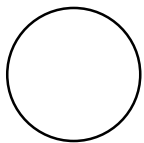

white

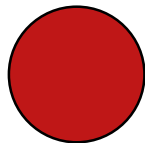

red
3003

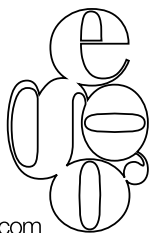

STRUTTURA Realizzata in legno abbinato a particelle di legno grezzo biodegradabile e pannelli di fibra di legno duro.

IMBOTTITURE Cuscini di seduta, braccioli, poggiatesta e spalliere poggiatesta reclinabili sono realizzate in poliuretano espanso a densità differenziate. Tutte le parti sopraelencate sono ricoperte da una termofalda di dacron autoestinguente.

Cuscini di seduta: strato superiore: densità 30 kg/mc. Strato inferiore: densità 35 kg/mc, rivestiti con falda di dacron in fibra di poliestere da 100 gr/mq. Poggiatesta: densità 30 kg/mc. Termofalda di dacron in fibra di poliestere da 450 gr/mq. Braccioli: densità 30 kg/mc. Doppia falda di dacron resinato da 200 gr/mq. Spalliere poggiatesta: densità 23 kg/mc. Termofalda di dacron in fibra di poliestere da 450 gr/mq.

Imbottiture di completamento: densità 21 kg/mc.

RIVESTIMENTO Pelle, tessuto o microfibra. Non sfoderabile. Per le caratteristiche del rivestimento e della manutenzione vedere relative schede tecniche.

PIEDI In ABS. H = cm 3

NOTE Nella versione relax il modello è dotato esclusivamente di doppio meccanismo elettrico con comandi touch sensor posizionati nello spazio interno tra seduta e bracciolo. Gli elementi centrali relax sono anche essi dotati di comandi touch sensor posti sul fianco della seduta. I comandi possono agire indipendentemente tra di loro variando solo l'inclinazione della testiera oppure permettendo di distendere solo le gambe offrendo infinite possibilità di comfort. Gli elementi relax sono sempre staccati da quelli fissi e vengono aganciati con apposito sistema a baionetta. Nelle versioni fisse senza meccanismo relax in ogni caso è presente il cricchetto manuale nelle testiere.

COVERING Leather or microfiber. Not removable. Please check covering details for care instructions.

PADDING Seat cushion, armrest, kidney rest and inclining headrest in double density polyurethane foam covered with a layer of goose feathers.

Seat cushion: Polyurethane foam 30kg/m3. Headrest and Kidney rests: Polyurethane foam 23kg/m3. Armrests : Polyurethane foam 30kg/m3.

Frame padding: 21 kg/m3

FRAME Hard wood combined with plywood and particle board.

FEET ABS feet. Height 3 cm

NOTE In the relax version the model is equipped exclusively with a double electric mechanism with touch sensor controls positioned in the internal space between the seat and the armrest. The central elements with recliners are also equipped with touch sensor controls on the side of the seat. The controls can act independently of each other, varying only the inclination of the headrest or allowing to stretch only the legs, offering endless possibilities of comfort. The relax elements are always detached from the fixed ones and are attached with a special bayonet system. In the fixed versions without recliner mechanism, headrest are always equipped with a manual ratchet mechanism.

STRUCTURE En bois combiné avec du bois non traité et biodégradables et des panneaux de fibres de bois dur.

REMBOURRAGE Coussins d'assise, accoudoirs, cale-reins et dossiers appuie-tête inclinables réalisés en polyuréthane expansé à densité différenciée recouvert d'une couche de plumes d'oie.

Coussins d'assise: Polyuréthane expansé 30 Kg/m3.

Accoudoirs: Polyuréthane expansé 30 Kg/m3.

Appuie-tête et Cale-reins: Polyuréthane expansé 23 Kg/m3

Rembourrage de complément: densité 21 Kg/m3

RETEVEMENT Cuir, microfibre ou tissu non déhoussable. Pour les caractéristique du revêtement aussi bien que pour l'entretien veuillez consulter les fiches techniques appropriées.

PIEDS En ABS h 3 cm

NOTE Dans la version relax, le modèle est équipé exclusivement d'un double mécanisme électrique avec commandes tactiles positionnées dans l'espace interne entre le siège et l'accoudoir. Les chauffeuses avec relax sont également équipées de commandes tactiles sur le côté du siège. Les commandes peuvent agir indépendamment les unes des autres, ne faisant varier que l'inclinaison de la tête ou vous permettant d'étirer uniquement les jambes, offrant des possibilités infinies de confort. Les éléments avec relax sont toujours détachés des éléments fixes et sont accrochés avec un système spécial à baïonnette. Dans les versions fixes sans mécanique relax, il y a en tout cas un cliquet manuel dans les têtes.

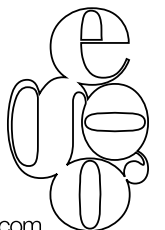
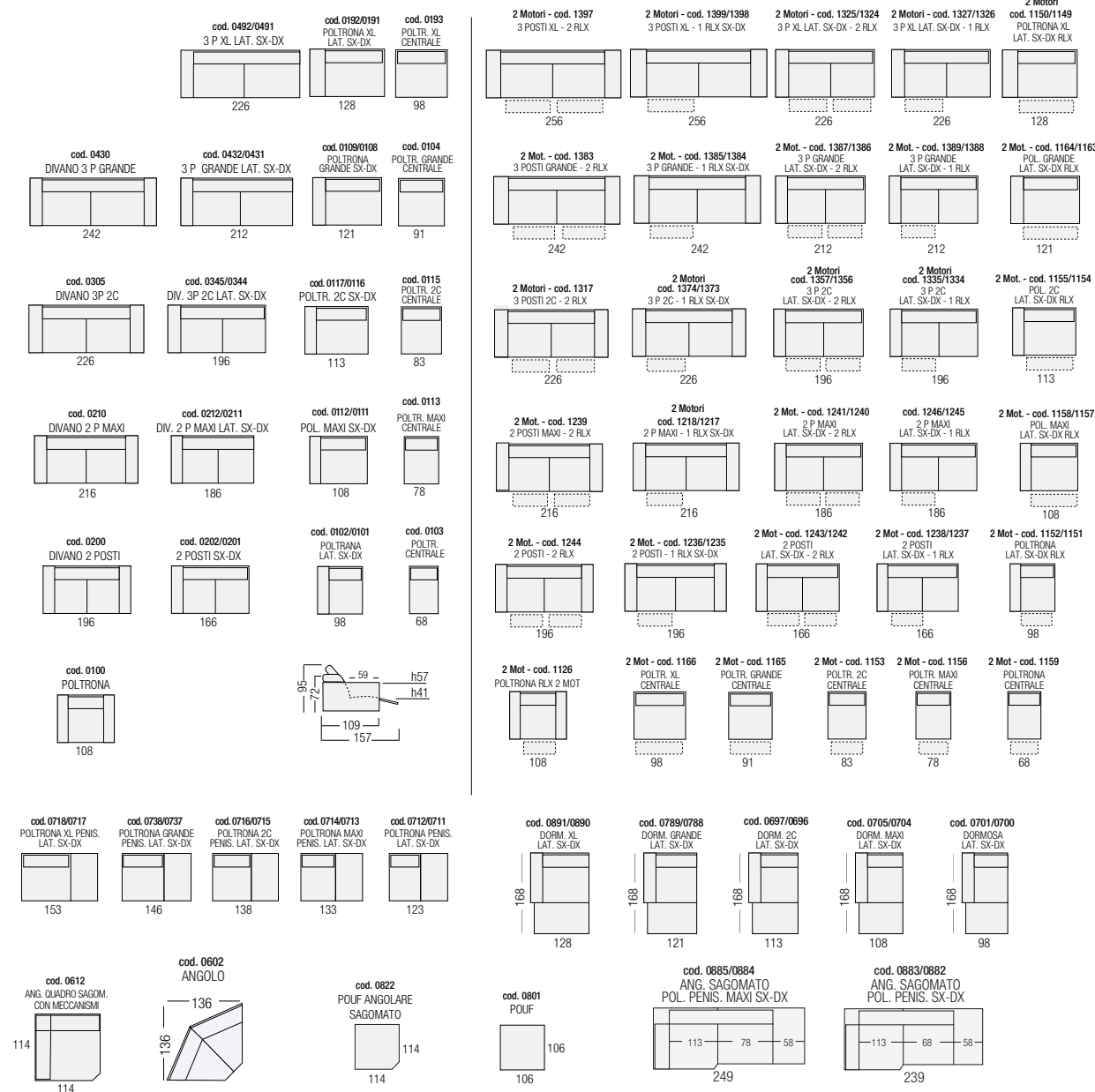

STRUTTURA Realizzata in legno abbinato a particelle di legno grezzo biodegradabile e pannelli di fibra di legno duro.

IMBOTTITURE Cuscini di seduta, braccioli e schienali reclinabili sono realizzati in poliuretano espanso, ricoperte da una termofalda di dacron autoestinguente. Cuscini di seduta: strato superiore di densità 30 kg/mc soffice, strato inferiore di densità 30 kg/mc portante. Termofalda da 350 gr/mq. Braccioli: densità 40 kg/mc. Termofalda da 100 gr/mq. Schienali reclinabili: densità 23 kg/mc. Termofalda da 350 gr/mq. Imbottiture di completamento: densità 21 kg/mc.

RIVESTIMENTO Pelle, microfibra o tessuto non sfoderabile. Per le caratteristiche del rivestimento e della manutenzione vedere relative schede tecniche.

PIEDI realizzati in metallo con finitura in vernice epossidica nei colori presenti nella nostra palette. Variante in legno massello di faggio evaporato, tinto color noce toffee. H: cm 13

NOTE Nella versione relax il modello è dotato esclusivamente di un doppio meccanismo elettrico con comando posizionato nello spazio interno tra seduta e bracciolo, mentre le sedute centrali sono dotate di un pratico telecomando. I comandi possono agire indipendentemente tra di loro variando solo l'inclinazione della testiera oppure permettendo di distendere solo le gambe offrendo infinite possibilità di comfort. Gli elementi relax sono sempre staccati da quelli fissi e vengono agganciati con apposito sistema a baionetta. Nelle versioni fisse senza meccanismo relax in ogni caso è presente il cricchetto manuale nelle testiere.

FRAME Hardwood combined with plywood and particle board covered by a layer of polyurethane foam.

PADDING Seat cushion, armrests and backrests are made in polyurethane foam with varying density covered with a layer of self extinguishing dacron

Seat cushions: Upper part density 30 kg/m3 soft, bottom part density 30 kg/m3 strong. Dacron layer 350 gr/m2.

Armrests: Polyurethane foam 40 kg/m3 . Armrests are covered with a Dacron layer 100 gr/mq.

Backrests: Polyurethane foam 23 kg/m3. Dacron layer 350 gr/m2. Frame padding: 21 kg/m3

COVERING Leather, fabric or microfiber. Not removable. Please check covering details for care instructions.

FEET In metal with epoxy powder finish, in the optional colours available in its palette. Wooden legs also available. Made of solid evaporated beech coloured walnut or toffee. H 13 cm.

NOTE The relax version is exclusively available with double electric mechanism having the controls placed on the seat cushion side, between the seat and the armrest. The armless seats are equipped with a practical remote control. The mechanisms are independent, allowing you to adjust to the desired comfort position either the headrest or the footrest. The version without mechanism always carries the mechanical headrest. The part with relax is always delivered separately and connected to the fixed part by made for purpose bayonet fittings.

STRUCTURE En bois, multiplies et particules habillés d'une couche de polyuréthane expansé.

REMBOURRAGE Coussins d'assise, accoudoirs, et dossiers en polyuréthane expansé à double densité recouvert par une couche de dacron autoextinguible. Coussins d'assise : Partie supérieure densité 30 kg/m3 souple et partie inférieure densité 30 kg/m3 portant. Dacron 350 gr/m2.

Accoudoirs: Polyuréthane expansé 40 kg/m3 . Couche de dacron 100 gr/m2. Dossiers: Polyuréthane expansé 23 kg/mc recouvert avec une couche de dacron 350 gr/m2.

Rembouillage de complément : densité 21 kg/m3.

REVETEMENT Cuir, microfibra ou tissu en déhoussable. Pour les caractéristique du revêtement aussi bien que pour l'entretien veuillez consulter les fiches techniques appropriés.

PIEDS En métal finition peinture à poudre époxy dans les finition prévue dans sa palette. Version en bois de hêtre évaporé teinté noyer ou toffee. H 13 cm.

NOTE En version relax le modèle est disponible exclusivement avec doubleur mécanique électrique avec commande située sur le coté interne entre coussin d'assise et accoudoir, alors que les assises sans bras sont équipées d'une pratique télécommande. Les mécaniques peuvent agir de façon indépendante, permettant de bouger uniquement la tête ou l'assise pour obtenir votre confort idéal. Les versions sans relax ont toujours la tête mécanique. L'élément avec relax est toujours séparé des éléments fixes et relié avec un système à baïonnette.

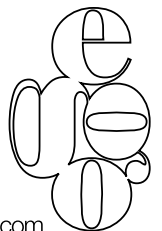
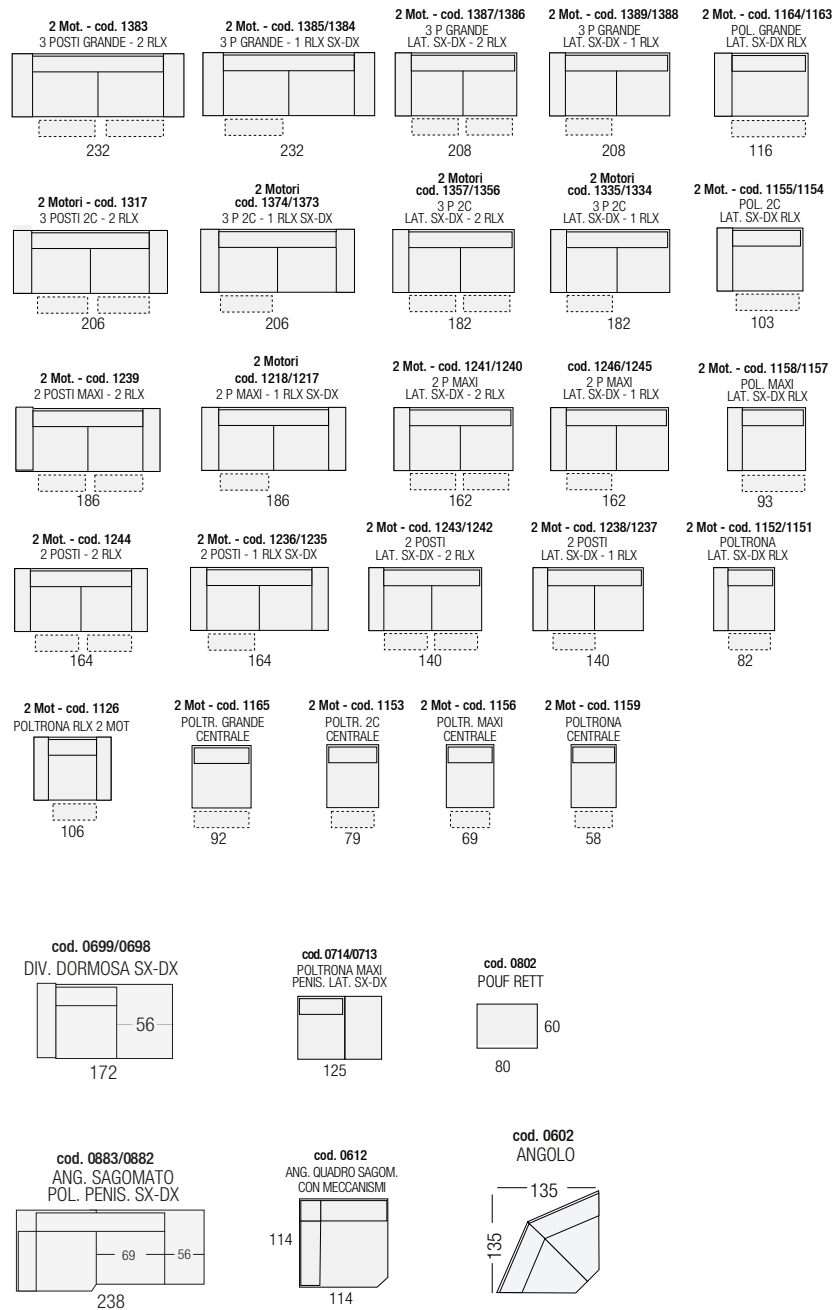
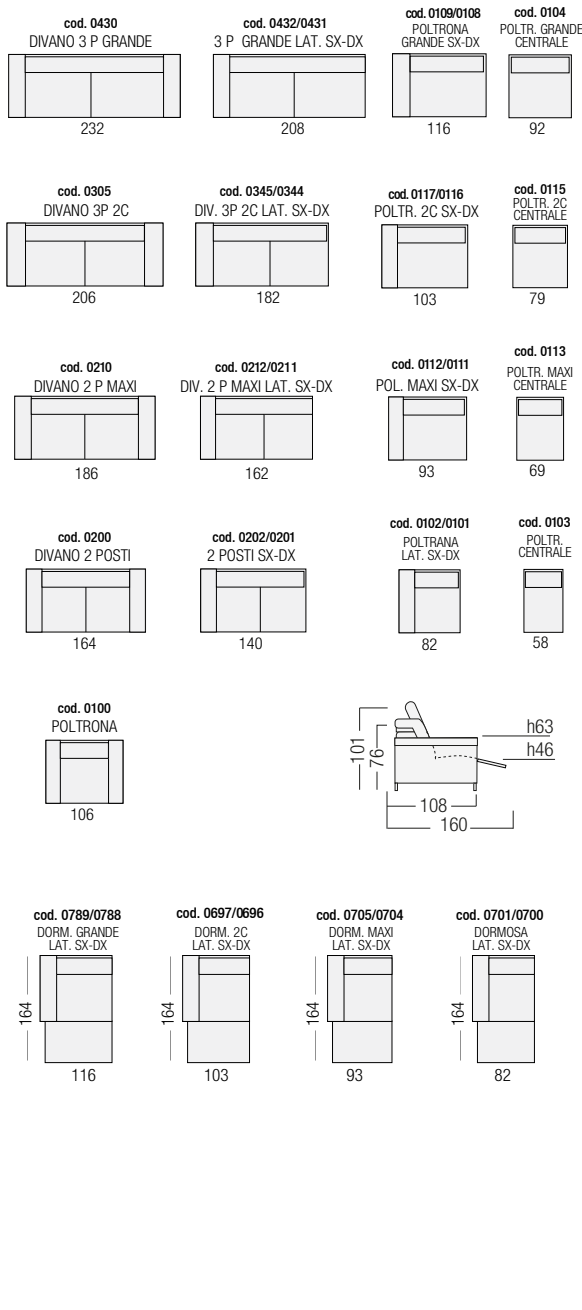

STRUTTURA Realizzata in legno abbinato a particelle di legno grezzo biodegradabile e pannelli di fibra di legno duro.

IMBOTTITURE Cuscini di seduta, braccioli, poggiatesta e schienali sono realizzati in poliuretano espanso a densità differenziate. Tutte le parti sopraelencate sono ricoperte da una termofalda di dacron autoestinguente.

Cuscini di seduta: strato superiore: densità 30 kg/mc. Termofalda da 350 gr/mq.

Braccioli: densità 30 kg/mc. Termofalda da 200 gr/mq.

Schienali e poggiatesta: densità 25 kg/mc. Termofalda da 200 gr/mq.

Imbottiture di completamento: densità 21 kg/mc.

RVESTIMENTO Pelle, tessuto o microfibra non sfoderabile. Per le caratteristiche del rivestimento e della manutenzione vedere relative schede tecniche.

PIEDI in ABS da cm 3

NOTE Nella versione relax il modello presenta un meccanismo a doppia funzione che permette di aumentare la profondità di seduta del divano di 10 centimetri e successivamente di aprire il poggiatesta. Disponibile esclusivamente nella versione elettrica con comando touch sensor posizionato tra il bracciolo e la seduta. L'elemento relax è sempre staccato da quello fisso e viene agganciato con apposito sistema a baionetta.

STRUCTURE Made of wood combined with biodegradable raw wood particles and hardwood fiber panels.

PADDING Seat cushions, armrests, backrests and lumbers are made of differentiated density polyurethane foam. All the parts listed above are covered with a self-extinguishing dacron layer.

Seat cushions: upper layer density 30 kg / mc. Dacron layer 350 gr / mq.

Armrests: density 30 kg / mc. Dacron layer 200 gr / mq.

Backrests and lumbar supports: density 25 kg / mc. Dacron layer 200 gr / mq.

Frame padding: density 21 kg / mc.

COVER Non-removable leather, fabric or microfiber. Please check covering details for care instructions.

FEET in ABS of 3 cm

NOTE In the relax version, the model has a dual-function mechanism that allows you to increase the seat depth of the sofa by 10 centimeters and then open the footrest. Available exclusively in the electric version with touch sensor control positioned between the armrest and the seat. The element with recliner mechanism is always detached from the fixed element and is hooked up with a special bayonet system.

STRUCTURE En bois combiné avec des panneaux de fibres de bois dur.

REMBOURRAGE Les assises, les accoudoirs, les dossiers et les cales reins sont fabriqués en mousse de polyuréthane à densité différenciée. Toutes les pièces énumérées ci-dessus sont recouvertes d'une couche en dacron auto-extinguible. Coussins d'assise: couche supérieure: densité 30 kg / mc. Couche de dacron de 350 gr / mq.

Accoudoirs: densité 30 kg / mc. Couche de dacron de 200 gr / mq.

Dossiers et supports lombaires: densité 25 kg / mc. Couche de dacron de 200 gr / mq.

Rembourrage de complément: densité 21 kg / mc.

RETEVEMENT Cuir, tissu ou microfibra non amovible. Pour les caractéristiques du revêtement et de son entretien, voir les fiches techniques correspondantes.

Pieds en ABS de 3 cm

NOTES Dans la version relax, le modèle dispose d'un mécanisme à double fonction qui vous permet d'augmenter la profondeur d'assise du canapé de 10 centimètres, puis d'ouvrir le repose-pieds. Disponible exclusivement dans la version électrique avec commande par capteur tactile positionnée entre l'accoudoir et le siège. L'élément avec relax est toujours détaché de l'élément fixe et est relié avec un système spécial à baïonnette.

VERSIONI CON MECCANISMO RELAX AZIONABILE SOLO ELETTRICAMENTE.

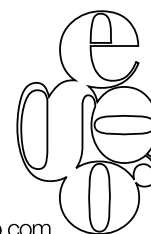
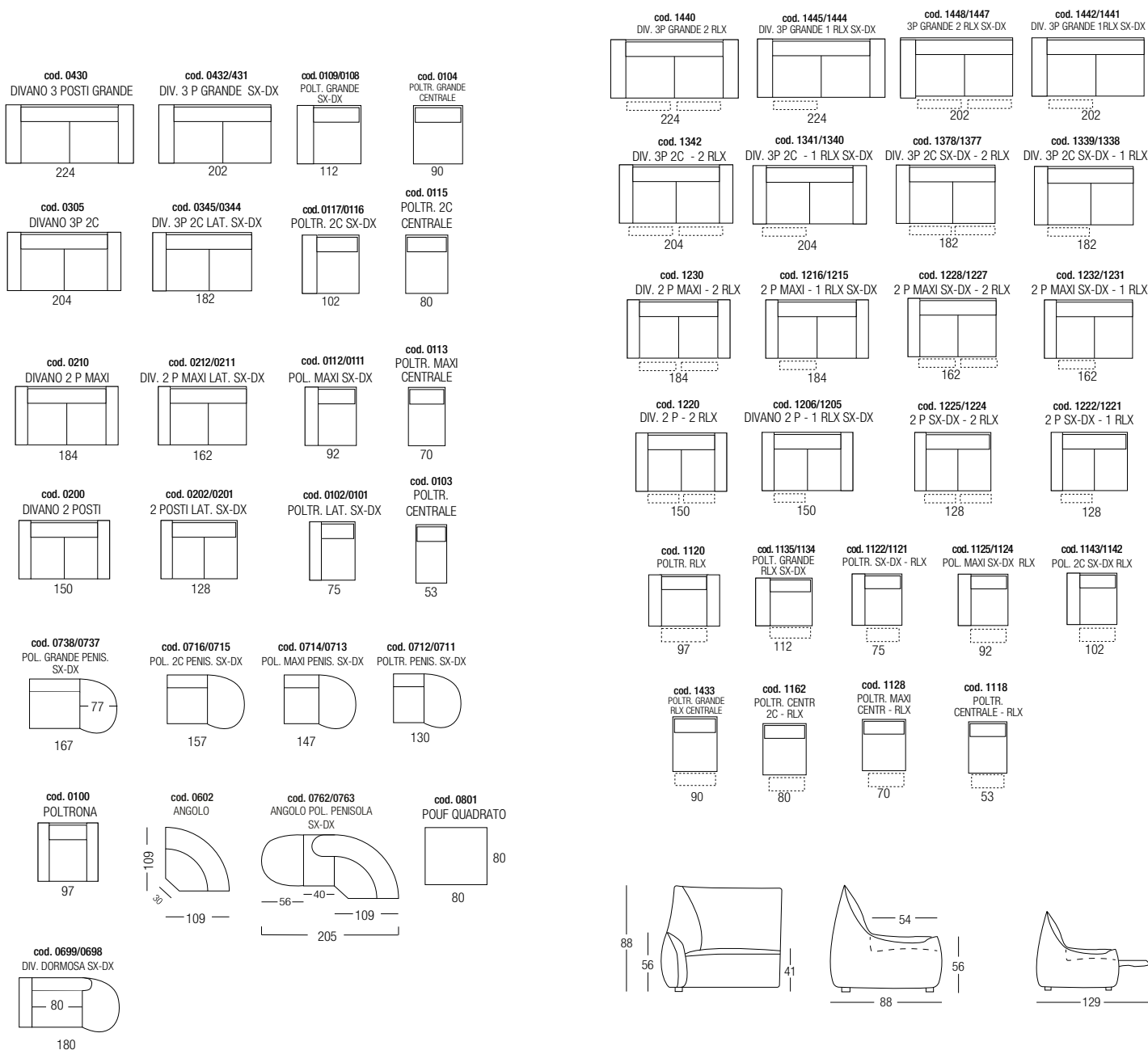

STRUTTURA Realizzata in legno multistrato con rinforzi in metallo.

IMBOTTITURE Cuscino schienale, cuscino di seduta e braccioli realizzati in poliuretano espanso di densità 30 kg/mc. Schienale e seduta sono ricoperti entrambi da una termofalda di dacron autoestinguente da 200 gr/mq.

RIVESTIMENTO Pelle, tessuto o microfibra non sfoderabile. Per le caratteristiche del rivestimento e della manutenzione vedere relative schede tecniche.

PIEDI Struttura in acciaio verniciato con polveri epossidiche nei colori nero opaco, grigio ombra, testa di moro, bianco, oppure realizzabile nelle finiture titanio o acciaio lucido.

FRAME Made of multilayer wood with metal reinforcements.

PADDING Back cushions, seat cushions and armrests made of 30 kg / mc density polyurethane foam. Back and seat are covered by a self-extinguishing 200 g / m² dacron layer.

COVERING Non-removable leather, fabric or microfiber. For the covering characteristics and its maintenance, see the relative technical data sheets.

FEET Steel frame painted with epoxy powders in matt black, shadow gray, dark brown, white, or can be made in titanium or polished steel finishes.

CARCASSE Fabriqué en bois multiplis avec des renforts métalliques.

REMBOURRAGE Coussins de dossier, coussins de siège et accoudoirs en mousse de polyuréthane de densité 30 kg / m². Le dossier et l'assise sont recouverts d'une couche en dacron thermique de 200 g / m², auto-extinguible.

REVETEMENT Cuir, tissu ou microfibre non amovible. Pour les caractéristiques du revêtement et de l'entretien, voir les fiches techniques correspondantes.

PIEDS Cadre en acier peint avec des poudres époxydiques en noir mat, gris ombre, brun foncé, blanc. Il peut être fabriqué en coloris titanium ou en acier poli.

cod. 0164
POLTRONCINA

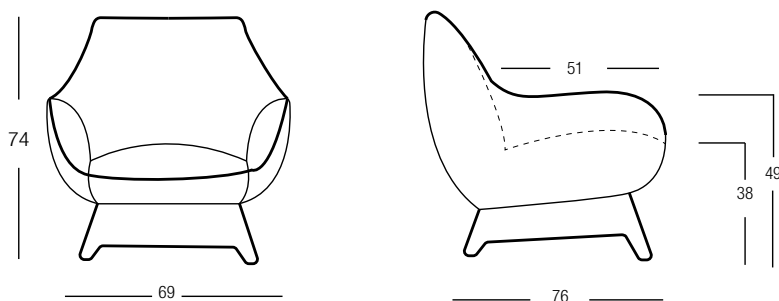

cod. 0183
POLTRONCINA
BERGERE

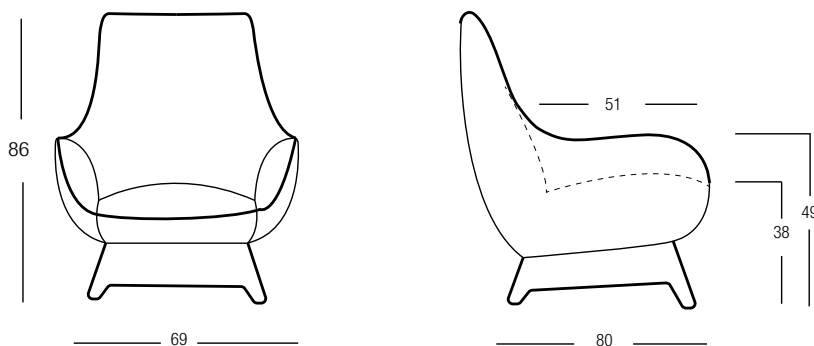

cod. 0200
DIVANO 2 POSTI

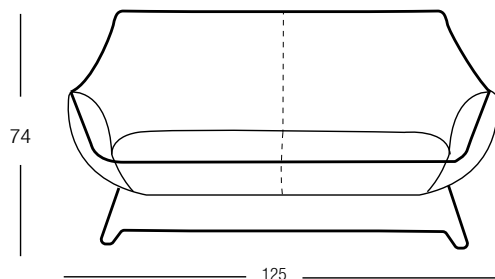

cod. 0801
POUF
QUADRATO

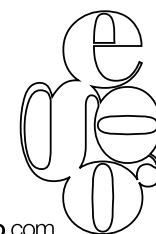
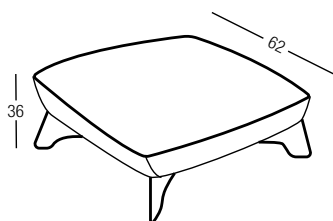

STRUTTURA Realizzata in legno abbinato a particelle di legno grezzo biodegradabile e pannelli di fibra di legno duro.

IMBOTTITURE Cuscini di seduta, braccioli, e schienale sono realizzati in poliuretano espanso a densità differenziate. Tutte le parti sopraelencate sono ricoperte da una termofalda di dacron autoestinguente.

Cuscini di seduta: densità 30 kg/mc. falda di dacron da 200 gr/mq.

Braccioli: densità 30 kg/mc. Termofalda da 200 gr/mq.

Schienale: densità 25 kg/mc. Termofalda da 200 gr/mq.

Imbottiture di completamento: densità 21 kg/mc.

RIVESTIMENTO Pelle, tessuto o microfibra. In tessuto o microfibra, su richiesta, il modello è disponibile anche in versione sfoderabile. Si prega di fare riferimento al listino prezzi appropriato. Per le caratteristiche del rivestimento e della manutenzione vedere relative schede tecniche.

PIEDI versione 1: base circolare girevole in acciaio. Realizzata nelle finiture metalliche o nelle tinte a base di polveri epossidiche previste sulle palette disponibili.

H base: cm 10

versione 2: In acciaio, nelle finiture metalliche o nelle tinte a base di polveri epossidiche previste sulle palette disponibili. H alla base del divano: cm 12

NOTE Nella versione 1 il modello è realizzato con lo speciale meccanismo manuale GLIDER, il quale viene ancorato alla base girevole e permette un rilassante effetto dondolo.

COVERING Leather, fabric or Microfiber. In fabric or microfiber, upon request, the model is also available with fully removable covers. Please refer to the appropriate price list. Not removable. Please check covering details for care instructions.

PADDING Seat cushion, armrests and backrests are made in polyurethane foam with varying density. Every part mentioned above is covered by a Dacron layer.

Seat cushions: In polyurethane foam 30 kg/m3. Covered by a dacron layer 200 gr/m2.

Armrests: Polyurethane foam 30 kg/m3. Dacron layer 200 gr/m2.

Backrests: Polyurethane foam 25 kg/m3. Dacron layer 200 gr/m2.

Frame padding: Polyurethane foam 21 kg/m3.

FRAME Hardwood combined with plywood and particle board.

FEET version 1: Round stainless steel swivel base. It is available in epoxy finish colours or according to its palette. Height to the base of the sofa 10cm. version 2: Feet in stainless steel available in epoxy finish colors or according to its palette. Height to the base of the sofa 12cm.

NOTE In version 1 the model is made with the special manual GLIDER mechanism, which is anchored to the swivel base and allows a relaxing rocking effect.

STRUCTURE En bois, multiples et particules habillés d'une couche de dacron.

REMBOURRAGE Coussins d'assise, accoudoirs et dossiers en polyuréthane expansé à densité différenciée. Toutes les parties indiquées sont couvertes par une couche de dacron.

Coussins d'assise: en polyuréthane expansé 30 kg/m3. Couche en dacron 200 gr/m2.

Accoudoirs: Polyuréthane expansé 30 kg/m3 recouvert avec une couche de dacron 200 gr/m2.

Dossiers: Polyuréthane expansé 25 kg/m3 recouvert avec une couche de dacron 200 gr/m2.

Rembourrage de complément: densité 21 kg/m3.

REVETEMENT Cuir, tissu ou microfibre. En tissu ou microfibre, sur demande, le modèle est aussi disponible avec revêtement totalement déhoussable. Merci de vous référer au tarif correspondant. Pour les caractéristiques du revêtement aussi bien que pour l'entretien veuillez consulter les fiches techniques appropriées.

PIEDS version 1: Base ronde pivotante en acier. Disponible dans les couleurs en métal finis avec vernis à poudre ou bien dans les finitions prévues dans sa palette. Hauteur à la base 10 cm

version 2: Pied en acier fini avec vernis à poudre couleur dans les finitions prévues dans sa palette. Hauteur à la base du canapé 12 cm

NOTE Dans la version 1, le modèle est réalisé avec le mécanisme manuel spécial GLIDER, qui est ancré à la base pivotante et permet un effet de balancement relaxant.

cod. 0123
POLTRONCINA
CON BASE GIREVOLE

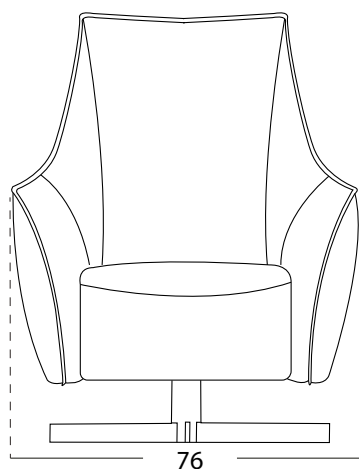

cod. 0164
POLTRONCINA

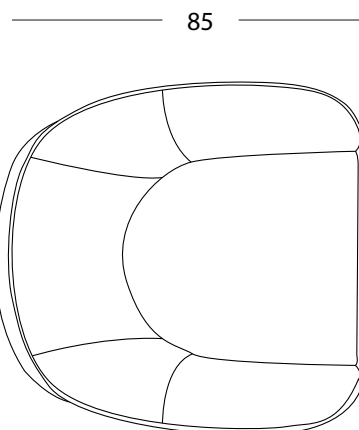
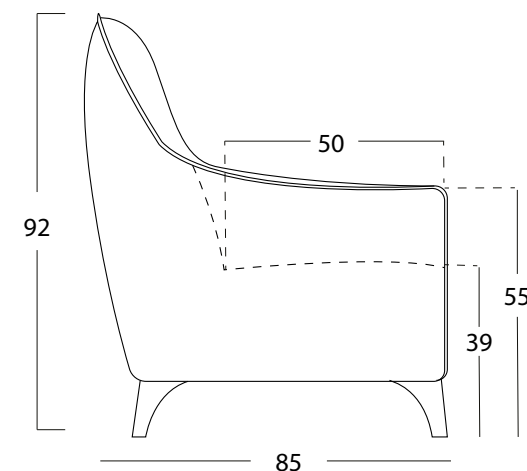
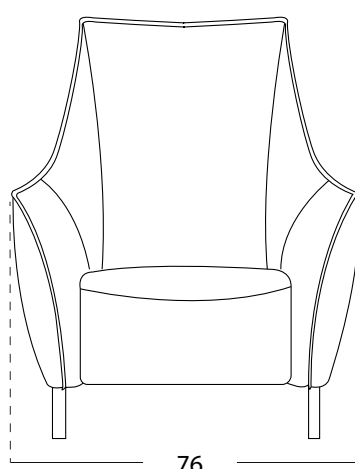

cod. 0823
POUFF
CON BASE

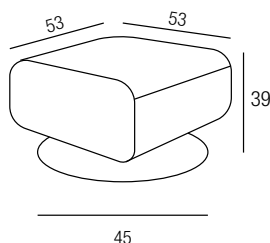

cod. 0801
POUFF
QUADRATO

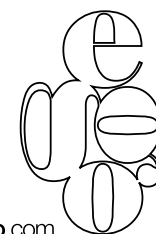
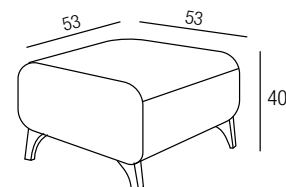

STRUTTURA Realizzata in legno abbinato a particelle di legno grezzo biodegradabile e pannelli di fibra di legno duro.

IMBOTTITURE Cuscino schienale realizzato in poliuretano espanso di densità 30 kg/mc. con zona poggiatesta di densità 23 kg/mc. Cuscino di seduta realizzato in poliuretano espanso di densità 30 kg/mc. Schienale e seduta sono ricoperti entrambi da una termofalda di dacron autoestinguente da 350 gr/ mq. Le imbottiture di completamento sono realizzate in poliuretano espanso di densità 21 kg/mc.

RIVESTIMENTO Pelle, tessuto o microfibra non sfoderabile. Per le caratteristiche del rivestimento e della manutenzione vedere relative schede tecniche.

PIEDI La poltroncina poggia su una base girevole a stella e misura cm 19 in altezza e cm 60 di diametro. E' possibile richiedere la base realizzata nelle finiture: acciaio lucidato, titanio, ottone spazzolato.

FRAME Hardwood combined with plywood and particle board covered by a layer of polyurethane foam.

PADDING Backrests are made in polyurethane foam 30kg/m3 with lumbar support with density 23 kg/m3. Seat cushion in polyurethane foam density 30 Kg/m3. All the above parts are covered by a layer of Dacron 350gr/m2. Frame padding in polyurethane foam density 21 kg/m2.

COVERING Leather, fabric or microfiber. Not removable. Please check covering details for care instructions.

FEET The chair is characterized by a star shaped swivel base measuring 19 cm height and 60cm of diameter. The base is available in shiny chrome finish, titanium or brushed brass.

STRUCTURE En bois, multiplies et particules habillées d'une couche de polyuréthane expansé.

REMBOURRAGE Dossier en mousse de polyuréthane expansé 30Kg/mc avec cales reins densité 23Kg/mc. Assise en mousse de polyuréthane expansé 30Kg/mc. Toutes parties sont couvertes par une couche de dacron 350gr/m2. Rembourrage de complément en polyuréthane expansé 21Kg/mc.

REVETEMENT Cuir, tissu ou microfibre non déhoussable. Pour les caractéristique du revêtement aussi bien que pour l'entretien veuillez consulter les fiches techniques appropriés.

PIEDS Le fauteuil est caractérisé par une base pivotante en forme d'étoile ayant 19cm d'hauteur et 60 cm de diamètre. La base est disponible dans les finitions acier brillant, titane et cuivre brossé.

cod. 0123
POLTRONCINA
CON BASE GIREVOLE

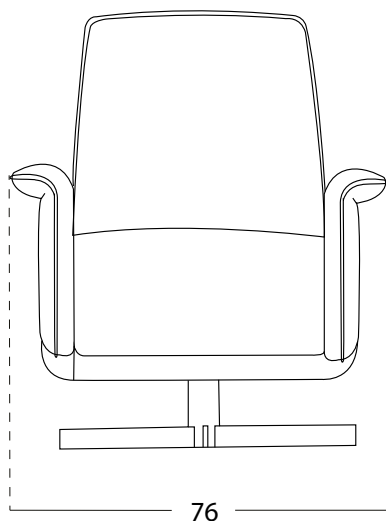

cod. 0823
POUFF
CON BASE

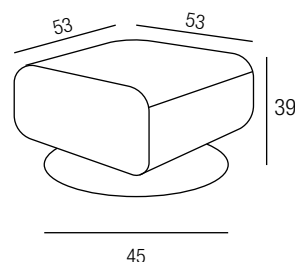

cod. 0801
POUFF
QUADRATO

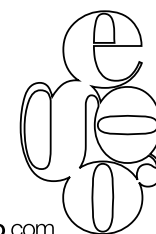
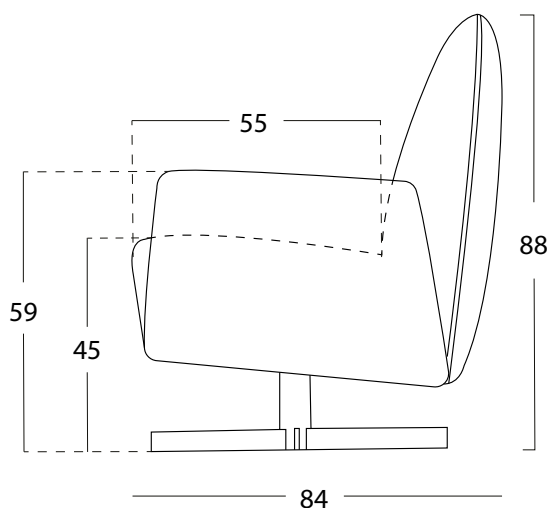
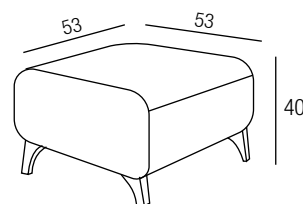

STRUTTURA Realizzata in legno abbinato a particelle di legno grezzo biodegradabile e pannelli di fibra di legno duro.

IMBOTTITURE Cuscini di seduta in poliuretano espanso a densità differenziata ricoperti da un materassino realizzato in piuma d'oca. Guanciali braccioli e cuscini schienali sono realizzati in piuma d'oca con inserto interno in poliuretano espanso. Scocca esterna in poliuretano espanso ricoperto da una falda di dacron autoestingente.

Cuscini di seduta: densità 30 kg/mc. Parte anteriore: densità 35 kg/mc. Materassino esterno in piuma d'oca.

Guanciali braccioli: piuma d'oca con inserto in poliuretano espanso densità 35 kg/mc.

Cuscini schienali: piuma d'oca con inserto in poliuretano espanso densità 23 kg/mc.

Scocca esterna: tampono superiore bracciolo e spalliera in poliuretano espanso densità 30 kg/mc. con completamenti in poliuretano espanso densità 21 kg/mc, ricoperta con termofalda di dacron da 200 gr/mq. Imbottiture di completamento: densità 21 kg/mc.

RIVESTIMENTO Pelle, tessuto o microfibra. Sono sfoderabili solo i cuscini di seduta, schienali e guanciali braccioli. Per le caratteristiche del rivestimento e della manutenzione vedere relative schede tecniche.

PIEDI Struttura in metallo verniciato con colori a base di polveri epossidiche nelle tinte previste sulle palette disponibili.

H alla base del divano: cm 16

FRAME Made of wood combined with biodegradable raw wood particles and hardwood fiber panels.

PADDING Seat cushions in differentiated-density polyurethane foam covered with a layer of goose down. Cushions and back cushions are made of goose down with internal insert in polyurethane foam. External polyurethane foam body covered with a self-extinguishing dacron layer.

Seat cushions: density 30 kg / mc. Front: density 35 kg / mc. External goose down layer.

Armrest cushions: In goose down with insert in polyurethane foam density 35 kg / mc.

Back cushions: In goose down with insert in polyurethane foam density 23 kg / mc.

External body: upper armrest and backrest in polyurethane foam density 30 kg / mc. with frame padding in polyurethane foam density 21 kg / mc, covered with 200 g / m² dacron layer.

Frame padding: density 21 kg / mc.

COVERING Leather, fabric or microfiber. Only seat cushions, backrests and armrests are removable. Please check cover details for care and maintenance instructions.

FEET Metal structure painted with epoxy powders varnishes in the colors provided on the available samples.

H at the base of the sofa: 16 cm

STRUCTURE En bois combiné avec des particules de bois bruts biodégradables et des panneaux de fibres de bois dur.

REMBOURRAGE Coussins d'assise en mousse de polyuréthane à densité différenciée recouverts d'un matelas en duvet d'oie. Les accoudoirs et les coussins de dossier sont en duvet d'oie avec insert interne en mousse de polyuréthane. Corps externe en mousse de polyuréthane recouvert d'une couche de dacron auto-extinguible.

Coussins d'assise: densité 30 kg / mc. Devant: densité 35 kg / mc. Matelas en duvet d'oie extérieur. Coussins d'accoudoir: duvet d'oie avec insert en mousse de polyuréthane d'une densité de 35 kg / mc.

Coussins de dossier: duvet d'oie avec insert en mousse de polyuréthane densité 23 kg / mc.

Corps externe: accoudoir supérieur et dossier en mousse de polyuréthane densité 30 kg / mc. avec finitions en polyuréthane expansé de densité 21 kg / mc, recouvert de 200 g / m² de dacron résistant à la chaleur.

Rembourrage de finition: densité 21 kg / mc.

COUVERTURE Cuir, tissu ou microfibre. Seuls les coussins d'assise, les dossiers et les accoudoirs sont amovibles. Pour les caractéristiques du revêtement et pour son entretien, voir les fiches techniques correspondantes.

Pieds Structure en métal peint avec des couleurs à base de poudres époxy dans les couleurs fournies sur les liasses disponibles. H à la base du canapé: 16 cm

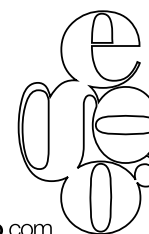
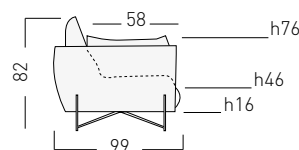
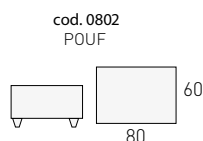
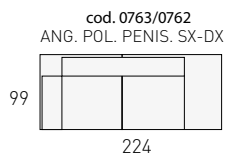
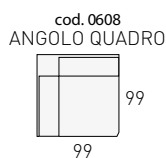
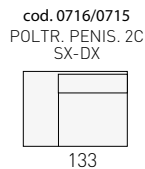
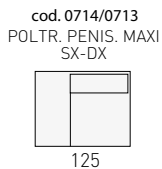
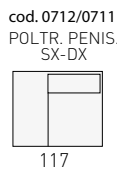
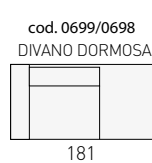
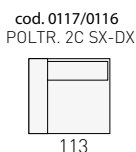
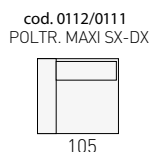
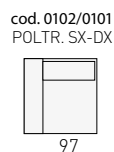
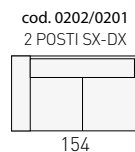
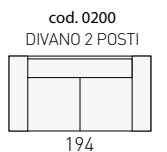
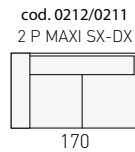
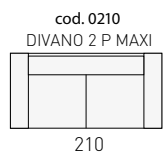
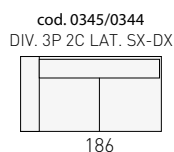
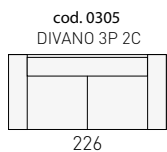

STRUTTURA Realizzata in legno abbinato a particelle di legno grezzo biodegradabile e pannelli di fibra di legno duro.

IMBOTTITURE Braccioli, poggiatesta e spalliere poggiatesta reclinabili sono realizzate in poliuretano espanso a densità differenziate. Tutte le parti sopraelencate sono ricoperte da una termofalda di dacron autoestinguente.

Cuscini di seduta: densità 30 kg/mc. Falda in dacron resinato da 350 gr/mq.

Braccioli: densità 21 kg/mc. Termofalda da 200 gr/mq.

Poggiatesta: densità 23 kg/mc. Termofalda da 350 gr/mq.

Spalliere poggiatesta: densità 23 kg/mc. Termofalda da 350 gr/mq.

Imbottiture di completamento: densità 21 kg/mc.

RIVESTIMENTO Pelle, tessuto o microfibra non sfoderabile. Per le caratteristiche del rivestimento e della manutenzione vedere relative schede tecniche.

PIEDI In ABS nero da cm 3

NOTE Nella versione relax il modello è realizzato con meccanismo combinato con movimento schienale poggiatesta, disponibile esclusivamente in versione elettrica con comando posizionato sul lato esterno del divano.

L'elemento relax è sempre staccato da quello fisso e viene agganciato con apposito sistema a baionetta.

Gli schienali sono dotati di meccanismo manuale a cricchetto, reclinabili a seconda del comfort desiderato.

FRAME Hardwood combined with plywood and particle board.

PADDING Seat cushion, lumbar supports, armrests and backrests are made in polyurethane foam with varying density. Every part mentioned above is covered by a Dacron layer.

Seat cushions: In polyurethane foam 30 kg/m3. Covered by a dacron layer 200 gr/m2.

Armrests: Polyurethane foam 21 kg/m3. Dacron layer 200 gr/m2.

Lumbar supports: Polyurethane foam 23 kg/m3. Dacron layer 350 gr/m2.

Backrests: Polyurethane foam 23 kg/m3. Dacron layer 350 gr/m2.

Frame padding: Polyurethane foam 21 kg/m3.

COVERING Leather, fabric or Microfiber. Non removable. Please check covering details for care instructions.

FEET In Black ABS. 3 cm

NOTE In the relax version, the model is equipped exclusively with an electric mechanism with control panel positioned on the external side of the armrest, while the central seats are equipped with a touch control system, positioned between the seats. The relax elements are always detached from the fixed ones and are hooked with a special bayonet system.

The backrests are equipped with a manual ratchet mechanism, reclining according to the desired comfort.

STRUCTURE En bois, multiples et particules habillés d'une couche de dacron.

REMBOURRAGE Coussins d'assise, cales reins, accoudoirs et dossiers en polyuréthane expansé à densité différenciée. Toutes les parties indiquées sont couvertes par une couche de dacron.

Coussins d'assise: en polyuréthane expansé 30 kg/m3. Couche en dacron 350 gr/m2.

Accoudoirs: Polyuréthane expansé 21 kg/m3 recouvert avec une couche de dacron 200 gr/m2.

Cales reins: Polyuréthane expansé 23 kg/m3 recouvert avec une couche de dacron 350 gr/m2.

Dossiers: Polyuréthane expansé 23 kg/m3 recouvert avec une couche de dacron 350 gr/m2.

Rembourrage de complément: densité 21 kg/m3.

REVETEMENT Cuir, tissu ou microfibra non déhoussable. Pour les caractéristiques du revêtement aussi bien que pour l'entretien veuillez consulter les fiches techniques appropriées.

PIEDS En ABS noir de 3 cm

NOTE Dans la version relax, le modèle est équipé exclusivement d'un mécanisme électrique avec contrôle positionné sur le côté extérieur de l'accoudoir, tandis que les chauffeuses sont équipées d'un système de contrôle tactile, positionné entre les sièges. Les éléments relax sont toujours séparés des éléments fixes et sont accrochés avec un système spécial à baïonnette.

Les dossiers sont équipés d'un mécanisme à cliquet manuel, inclinable selon le confort souhaité.

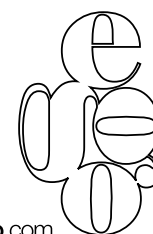
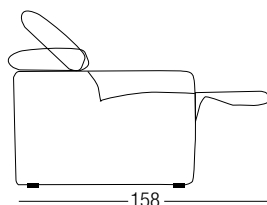
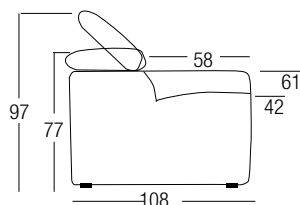
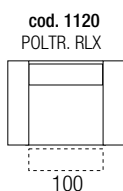
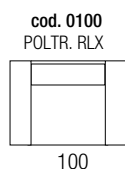
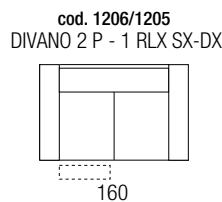
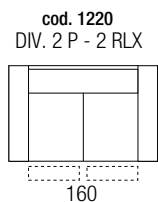
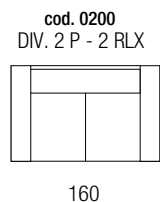
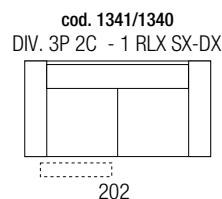
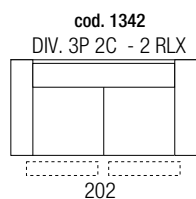
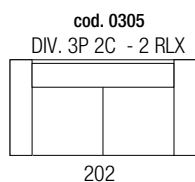

STRUTTURA Realizzata in legno abbinato a particelle di legno grezzo biodegradabile e pannelli di fibra di legno duro.

IMBOTTITURE Cuscini di seduta, braccioli, poggiatesta e schienali sono realizzate in poliuretano espanso a densità differenziate. Tutte le parti sopraelencate sono ricoperte da una termofalda di dacron autoestinguente.

Cuscini di seduta: densità 30 kg/mc. falda di dacron da 200 gr/mq.

Braccioli: densità 21 kg/mc. Termofalda da 200 gr/mq.

Spalliere poggiatesta e poggiatesta: densità 25 kg/mc. Termofalda da 350 gr/mq.

Imbottiture di completamento: densità 21 kg/mc.

RIVESTIMENTO Pelle, tessuto o microfibra non sfoderabile. Per le caratteristiche del rivestimento e della manutenzione vedere relative schede tecniche.

PIEDI Slitte in metallo nei colori previsti sulle palette disponibili. H alla base del divano: cm 12

NOTE Nella versione relax il modello è realizzato con meccanismo combinato con movimento schienale poggiatesta, disponibile esclusivamente in versione elettrica con comando posizionato sul lato esterno del divano.

L'elemento relax è sempre staccato da quello fisso e viene agganciato con apposito sistema a baionetta.

Gli schienali sono dotati di meccanismo manuale a cricchetto, reclinabili a seconda del comfort desiderato.

FRAME Hardwood combined with plywood and particle board.

PADDING Seat cushion, armrests and backrests are made in polyurethane foam with varying density. Every part mentioned above is covered by a Dacron layer.

Seat cushions: In polyurethane foam 30 kg/m3. Covered by a dacron layer 200 gr/m2.

Armrests: Polyurethane foam 21 kg/m3. Dacron layer 200 gr/m2.

Backrests: Polyurethane foam 25 kg/m3. Dacron layer 350 gr/m2.

Frame padding: Polyurethane foam 21 kg/m3.

COVERING Leather, fabric or Microfiber. Non removable. Please check covering details for care instructions.

FEET In painted metal with colors based on epoxy powders in the shades provided on the available palette. H at the base of the sofa: 12 cm.

NOTE In the relax version, the model is equipped exclusively with an electric mechanism with control panel positioned on the external side of the armrest, while the central seats are equipped with a touch control system, positioned between the seats. The relax elements are always detached from the fixed ones and are hooked with a special bayonet system.

STRUCTURE En bois, multiples et particules habillées d'une couche de dacron.

REMBOURRAGE Coussins d'assise, accoudoirs et dossiers en polyuréthane expansé à densité différenciée. Toutes les parties indiquées sont couvertes par une couche de dacron.

Coussins d'assise: en polyuréthane expansé 30 kg/m3. Couche en dacron 200 gr/m2.

Accoudoirs: Polyuréthane expansé 21 kg/m3 recouvert avec une couche de dacron 200 gr/m2.

Dossiers: Polyuréthane expansé 25 kg/m3 recouvert avec une couche de dacron 350 gr/m2.

Rembourrage de complément: densité 21 kg/m3.

RETEVEMENT Cuir, tissu ou microfibra non déhoussable. Pour les caractéristiques du revêtement aussi bien que pour l'entretien veuillez consulter les fiches techniques appropriées.

PIEDS Pieds en métal peint avec des couleurs à base de poudres époxy dans les couleurs fournies sur les palettes disponibles. H à la base du canapé: 12 cm

NOTE Dans la version relax, le modèle est équipé exclusivement d'un mécanisme électrique avec contrôle positionné sur le côté extérieur de l'accoudoir, tandis que les chauffeuses sont équipés d'un système de contrôle tactile, positionné entre les sièges. Les éléments relax sont toujours séparés des éléments fixes et sont accrochés avec un système spécial à baïonnette.

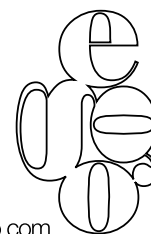
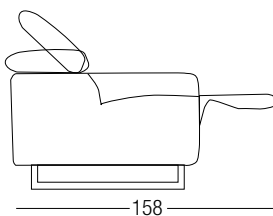
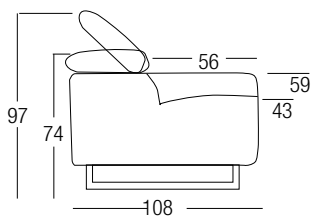
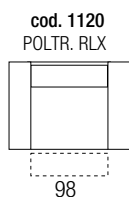
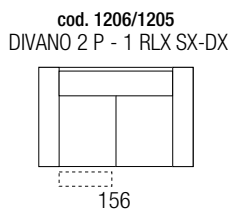
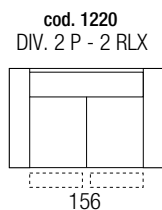
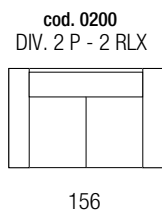
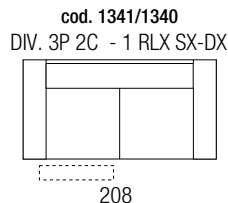
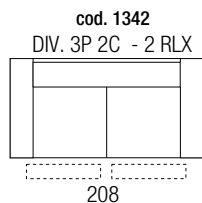
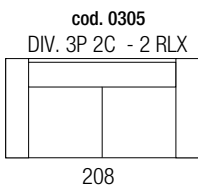

STRUTTURA Realizzata in legno abbinato a particelle di legno grezzo biodegradabile e pannelli di fibra di legno duro.

IMBOTTITURE Cuscini di seduta, braccioli, schienali e poggiatesta sono realizzati in poliuretano espanso a densità differenziate. Tutte le parti sopraelencate sono ricoperte da una falda di dacron autoestinguente.

Cuscini di seduta: densità 30 kg/mc. Falda di dacron resinato da 100 gr/mq.

Braccioli: densità 21 kg/mc. Falda di dacron resinato da 200 gr/mq.

Schienali e poggiatesta: densità 23 kg/mc. Falda di dacron resinato da 200 gr/mq.

Imbottiture di completamento: densità 21 kg/mc.

RIVESTIMENTO Pelle, tessuto o microfibra, non sfoderabile. Per le caratteristiche del rivestimento e della manutenzione vedere relative schede tecniche.

PIEDI Struttura bracciolo in metallo verniciato con colori a base di polveri epossidiche nelle tinte previste sulle palette disponibili. H alla base del divano: cm 12

NOTE Nella versione relax il modello è dotato esclusivamente di meccanismo elettrico con comando posizionato sul lato esterno del bracciolo. Gli elementi relax sono sempre staccati da quelli fissi e vengono agganciati con apposito sistema a baionetta.

FRAME Hardwood combined with plywood and particle board.

PADDING Seat cushion, armrests and backrests are made in polyurethane foam with varying density. Every part mentioned above is covered by a Dacron layer.

Seat cushions: In polyurethane foam 30 kg/m3. Covered by a dacron layer 100 gr/m2.

Armrests: Polyurethane foam 21 kg/m3. Dacron layer 200 gr/m2.

Backrests: Polyurethane foam 23 kg/m3. Dacron layer 200 gr/m2.

Frame padding: Polyurethane foam 21 kg/m3.

COVERING Leather, fabric or Microfiber. Non removable. Please check covering details for care instructions.

FEET In painted metal with colors based on epoxy powders in the shades provided on the available palette. H at the base of the sofa: 12 cm.

NOTE In the relax version, the model is equipped exclusively with an electric mechanism with control panel positioned on the external side of the armrest, while the central seats are equipped with a touch control system, positioned between the seats. The relax elements are always detached from the fixed ones and are hooked with a special bayonet system.

STRUCTURE En bois, multiples et particules habillés d'une couche de dacron.

REMBOURRAGE Coussins d'assise, accoudoirs et dossiers en polyuréthane expansé à densité différenciée.

Toutes les parties indiquées sont couvertes par une couche de dacron.

Coussins d'assise: en polyuréthane expansé 30 kg/m3. Couche en dacron 100 gr/m2.

Accoudoirs: Polyuréthane expansé 21 kg/m3 recouvert avec une couche de dacron 200 gr/m2.

Dossiers: Polyuréthane expansé 23 kg/m3 recouvert avec une couche de dacron 200 gr/m2.

Rembourrage de complément: densité 21 kg/m3.

REVESTEMENT Cuir, tissu ou microfibre non déhoussable. Pour les caractéristiques du revêtement aussi bien que pour l'entretien veuillez consulter les fiches techniques appropriées.

PIEDS Pieds en métal peint avec des couleurs à base de poudres époxy dans les couleurs fournies sur les palettes disponibles. H à la base du canapé: 12 cm

NOTE Dans la version relax, le modèle est équipé exclusivement d'un mécanisme électrique avec contrôle positionné sur le côté extérieur de l'accoudoir, tandis que les chauffeuses sont équipées d'un système de contrôle tactile, positionné entre les sièges. Les éléments relax sont toujours séparés des éléments fixes et sont accrochés avec un système spécial à baïonnette.

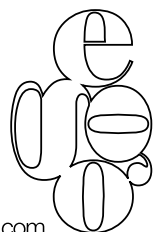
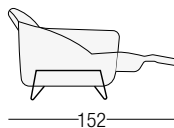
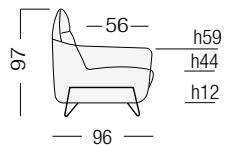
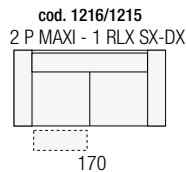
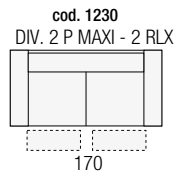
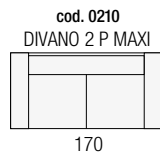
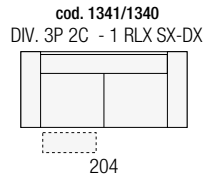
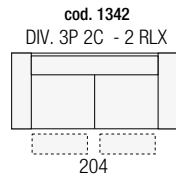
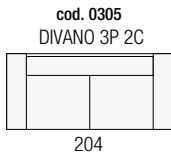
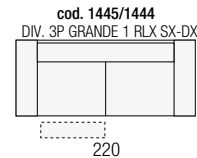
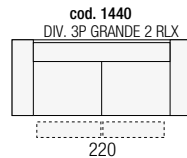
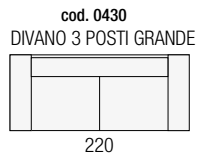

STRUTTURA Realizzata in legno abbinato a particelle di legno grezzo biodegradabile e pannelli di fibra di legno duro.

IMBOTTITURE Cuscini di seduta, braccioli, poggiatesta e schienali sono realizzati in poliuretano espanso a densità differenziate. Tutte le parti sopraelencate sono completate da una termofalda di dacron autoestinguente e rivestite con un materassino realizzato in piuma d'oca.

Cuscini di seduta: densità 30 kg/mc. Termofalda da 350 gr/mq. Materassino in piuma d'oca.

Braccioli: densità 30 kg/mc. Termofalda da 200 gr/mq. Materassino in piuma d'oca.

Poggiatesta: densità 30 kg/mc. Materassino in piuma d'oca.

Schienali: densità 23 kg/mc. Termofalda da 200 gr/mq. Materassino in piuma d'oca.

Imbottiture di completamento: densità 21 kg/mc.

RIVESTIMENTO Pelle, tessuto o microfibra non sfoderabile. Per le caratteristiche del rivestimento e della manutenzione vedere relative schede tecniche.

PIEDI in ABS da cm 3

NOTE Nella versione relax il modello presenta un meccanismo a doppia funzione che permette di aumentare la profondità di seduta del divano di 10 centimetri e successivamente di aprire il poggiatesta. Disponibile esclusivamente nella versione elettrica con comando touch sensor posizionato tra il bracciolo e la seduta. L'elemento relax è sempre staccato da quello fisso e viene agganciato con apposito sistema a baionetta.

STRUCTURE Made of wood combined with biodegradable raw wood particles and hardwood fiber panels.

PADDING Seat cushions, armrests, backrests and lumbers are made of differentiated density polyurethane foam. All the parts listed above are covered with a self-extinguishing dacron layer and subsequently covered by a feather filled topper.

Seat cushions: upper layer density 30 kg / mc. Dacron layer 350 gr / mq. Feather Topper.

Armrests: density 30 kg / mc. Dacron layer 200 gr / mq. Feather Topper.

Lumbar supports: density 30 kg / mc. Feather Topper.

Backrests: density 23 kg / mc. Dacron layer 200 gr / mq. Feather Topper.

Frame padding: density 21 kg / mc.

COVER Non-removable leather, fabric or microfiber. Please check covering details for care instructions.

FEET in ABS of 3 cm

NOTE In the relax version, the model has a dual-function mechanism that allows you to increase the seat depth of the sofa by 10 centimeters and then open the footrest. Available exclusively in the electric version with touch sensor control positioned between the armrest and the seat. The element with recliner mechanism is always detached from the fixed element and is hooked up with a special bayonet system.

STRUCTURE En bois combiné avec des panneaux de fibres de bois dur.

REMBOURRAGE Les assises, les accoudoirs, les dossiers et les cales reins sont fabriqués en mousse de polyuréthane à densité différenciée. Toutes les pièces énumérées ci-dessus sont recouvertes d'une couche en dacron auto-extinguible et d'une couche en plumes.

Coussins d'assise: densité 30 kg / mc. Couche de dacron de 350 gr / mq. Couette en plumes.

Accoudoirs: densité 30 kg / mc. Couche de dacron de 200 gr / mq. Couette en plumes.

Cales reins: densité 30 kg / mc. Couette en plumes.

Dossiers: densité 23 kg / mc. Couche de dacron de 200 gr / mq. Couette en plumes.

Rembouillage de complément: densité 21 kg / mc.

REVETEMENT Cuir, tissu ou microfibre non amovible. Pour les caractéristiques du revêtement et de son entretien, voir les fiches techniques correspondantes.

Pieds: en ABS de 3 cm

NOTES Dans la version relax, le modèle dispose d'un mécanisme à double fonction qui vous permet d'augmenter la profondeur d'assise du canapé de 10 centimètres, puis d'ouvrir le repose-pieds. Disponible exclusivement dans la version électrique avec commande par capteur tactile positionnée entre l'accoudoir et le siège. L'élément avec relax est toujours détaché de l'élément fixe et est relié avec un système spécial à baionnette.

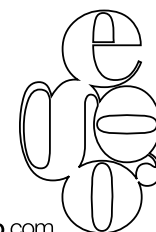
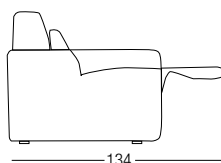
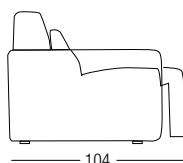
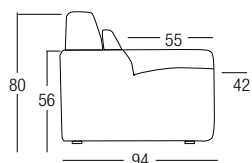
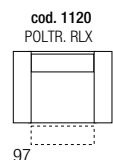
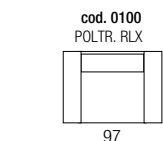
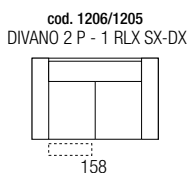
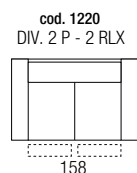
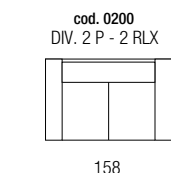
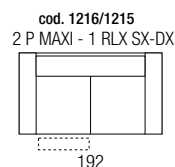
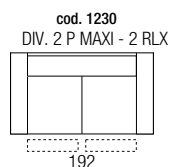
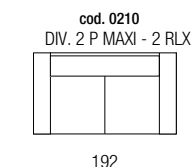
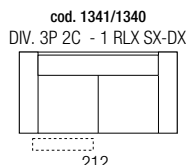
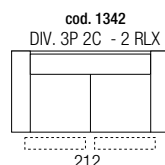
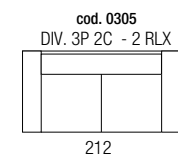
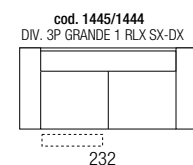
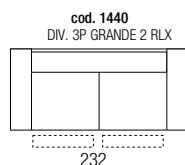
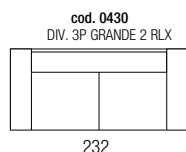

STRUTTURA Realizzata in legno abbinato a particelle di legno grezzo biodegradabile e pannelli di fibra di legno duro.

IMBOTTITURA Realizzata in poliuretano espanso a densità differenziate.

Cuscino di seduta e schienale:

densità 30 kg/mc rivestito da una termofalda di dacron da 200 gr/mq.

Braccioli:

densità 25 kg/mc. termofalda di dacron da 200 gr/mq.

RIVESTIMENTO Pelle, tessuto o microfibra non sfoderabile. Per le caratteristiche del rivestimento e la manutenzione vedere relative schede tecniche.

PIEDI Versione girevole: base circolare realizzata in tubolare d'acciaio verniciato, ruotante a 360°.

Versione fissa: piedi in ABS da cm 4.

STRUCTURE En bois combiné avec des particules de bois bruts biodégradables et des panneaux de fibres de bois dur.

REMBOURRAGE En mousse de polyuréthane expansé de différentes densités.

Coussin d'assise et de dossier:

polyuréthane expansé densité 30 kg / mc recouvert d'une couche de dacron de 200 gr/m².

Accoudoirs: polyuréthane expansé densité 25 kg / mc recouvert d'une couche de dacron de 200 gr/m².

RETEMENT Cuir, tissu ou microfibre non déhoussable. Pour les caractéristiques du revêtement et de la maintenance, voir les fiches techniques correspondantes.

PIEDS Version pivotante: base circulaire en tube d'acier peint tournant à 360°.

Version fixe: pieds ABS 4 cm.

RAME Made of wood combined with biodegradable raw wood particles and hardwood fiber panels.

PADDING Made of polyurethane foam with varied densities.

Seat and back cushion:

polyurethane foam density 30 kg / mc covered with a 200 gr / sqm dacron layer.

Armrests: polyurethane foam density 30 kg / mc covered with a 200 gr / sqm dacron layer.

COVERING Non-removable leather, fabric or microfiber. For the characteristics of the covering and maintenance see relative technical sheets.

FEET Swivel version: circular base made of painted steel tube, rotating at 360°.

Fixed version: 4 cm ABS feet.

cod. 0123
POLTRONCINA
GIRAVOLE

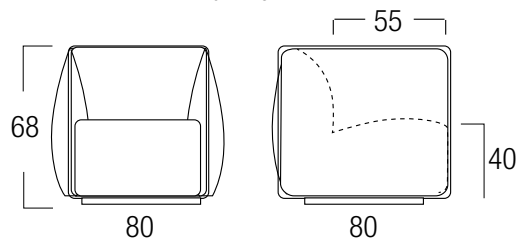

cod. 0164
POLTRONCINA
FISSA

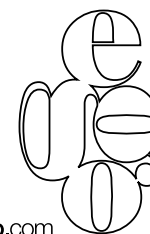
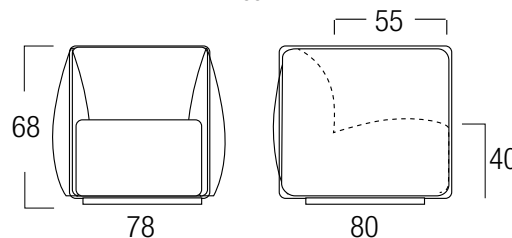

STRUTTURA Meccanica e leveraggi: in acciaio verniciato con polveri epossidiche.
Fusto: in legno abbinato a particelle di legno grezzo biodegradabile e pannelli di fibra di legno duro.

IMBOTTITURE Cuscino di seduta, braccioli e schienale sono realizzati in poliuretano espanso a densità differenziate. Tutte le parti sopraelencate sono ricoperte da una termofalda di dacron autoestinguente da 100 gr/mq. accoppiata con tela in fibra di poliestere.

Cuscino di seduta: densità 35 kg/mc.

Braccioli: densità 30 kg/mc.

Schienale: densità 30 kg/mc.

RIVESTIMENTO Pelle, tessuto o microfibra sfoderabile. Per le caratteristiche del rivestimento e della manutenzione vedere relative schede tecniche.

PIEDI In modalità pouf il modello poggia su rotelle multidirezionali; quando invece viene trasformato in poltroncina, poggia su ruote d'arredo unidirezionali, personalizzabili nei colori RAL previsti sulle palette disponibili.

NOTE QQ (si pronuncia "cucù") è il pouf che con un semplice gesto si trasforma in una simpatica poltroncina su grandi ruote d'arredo. Infatti basta sollevare il cuscino di seduta del pouf per scoprire QQ come poltroncina. Il suo design lineare e compatto si ispira alle geometrie bauhaus e arreda ogni ambiente con ironia.

STRUCTURE Mechanism and leverages in steel painted with epoxy powders.

Frame: in wood combined with biodegradable raw wood particles and hardwood fiber panels.

PADDING Seat cushion, armrests and backrest are made of polyurethane foam with different densities. All the parts listed above are covered with a 100 gr/mq self-extinguishing Dacron layer coupled with polyester fiber fabric.

Seat cushion: Polyurethane foam density 35 kg / mc.

Armrests: Polyurethane foam density 30 kg / mc.

Backrest: Polyurethane foam density 30 kg / mc.

COVERING Removable leather, fabric or microfiber. For the characteristics of the covering and maintenance see the relative technical data sheets.

FEET In footstool mode the model rests on multidirectional wheels; when instead it is transformed into an armchair, it rests on unidirectional furniture wheels, customizable in the RAL colors provided on the available palettes.

NOTE QQ (pronounced "Koo koo") is the footstool that with a simple gesture can be transformed into a nice armchair on large decorative wheels. In fact, it is enough to lift the seat cushion of the footstool to change QQ into an armchair. Its linear and compact design is inspired by Bauhaus geometries and furnishes every room with irony.

STRUCTURE Mécanique et leviers en acier peint avec des poudres époxydes.

Carcasse: en bois combiné avec des particules de bois bruts biodégradables et des panneaux de fibres de bois dur.

REMBOURRAGE Le coussin, les accoudoirs et le dossier sont en mousse de polyuréthane de différentes densités. Toutes les pièces sont recouvertes d'une couche en dacron auto extinguable de 100 gr / mq. couplé avec un tissu de fibre de polyester.

Coussin d'assise: mousse de polyuréthane densité 35 kg / mc.

Accoudoirs: mousse de polyuréthane densité 30 kg / mc.

Dossier: mousse de polyuréthane densité 30 kg / mc.

REVETEMENT Modèle déhoussable, en cuir, tissu ou microfibre. Pour les caractéristiques du revêtement et de la maintenance, voir les fiches techniques correspondantes.

PIEDS En modalité pouf, le modèle repose sur des roues multidirectionnelles; transformé en fauteuil, il repose sur des roulettes unidirectionnelles, personnalisables aux couleurs RAL fournies sur les palettes disponibles.

NOTES QQ (prononcé "coucou") est le pouf qui, d'un simple geste, se transforme en un joli fauteuil sur de grandes roues décoratives. En fait, il suffit de soulever le coussin de siège du pouf pour découvrir QQ en tant que fauteuil. Son design linéaire et compact s'inspire des géométries Bauhaus et donne à chaque pièce une touche ironique.

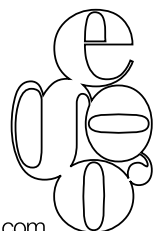
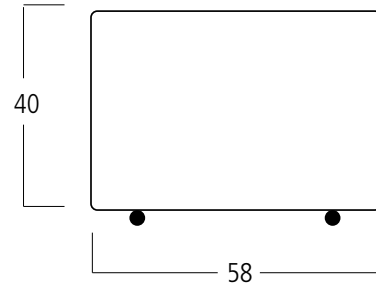
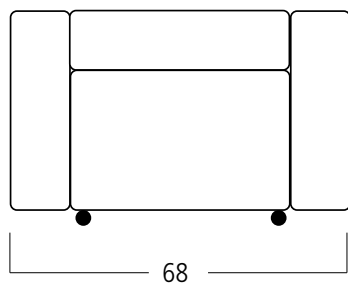
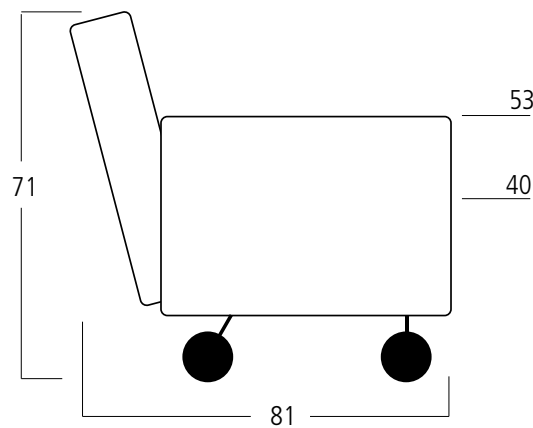
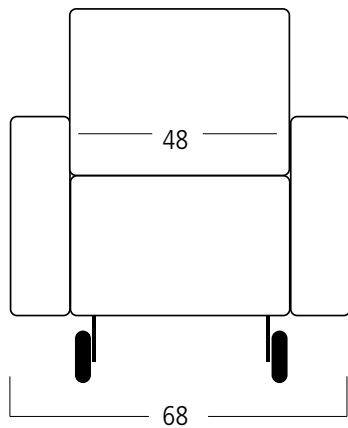

STRUTTURA Realizzata in legno abbinato a particelle di legno grezzo biodegradabile e pannelli di fibra di legno duro.

IMBOTTITURE Cuscino di seduta, braccioli e schienale sono realizzati in poliuretano espanso a densità differenziate. Tutte le parti sopraelencate sono ricoperte da una termofalda di dacron autoestingente.

Cuscino di seduta: densità 30 kg/mc. ricoperto con una termofalda in dacron resinato da 200 gr/mq.

Braccioli: densità 30 kg/mc. Termofalda da 200 gr/mq.

Schienale: densità 23 kg/mc. Termofalda da 200 gr/mq.

Imbottiture di completamento: densità 21 kg/mc.

RIVESTIMENTO Pelle, tessuto o microfibra non sfoderabile. Per le caratteristiche del rivestimento e della manutenzione vedere relative schede tecniche.

PIEDI base girevole in metallo, verniciata con colori a base di polveri epossidiche nelle tinte previste sulle palette disponibili. H base: cm 12

NOTE Il modello è realizzato con meccanismo combinato con movimento schienale poggiatesta. Tale meccanismo (push-arm) è facilmente azionabile facendo leva sui braccioli e reclinando la seduta nella propria posizione ideale. Blues è realizzabile esclusivamente con meccanismo manuale.

FRAME Hardwood combined with plywood and particle board.

PADDING Seat cushion, armrests and backrest in polyurethane foam with varying density. All parts are covered with a fire retardant Dacron layer.

Seat cushion: In polyurethane foam 30 kg/m3 covered with a layer of Dacron of 200 gr /sq m.

Armrests: in polyurethane foam 30 kg/m3 covered with a layer of Dacron of 200 gr /sq m.

Backrest: In polyurethane foam 23 kg/m3 covered with a layer of Dacron of 200 gr /sq m.

Frame padding: 21 kg/m3

COVERING Leather or microfiber. Not removable. Please check covering details for care instructions.

FEET The chair is equipped with a tubular steel circular base, available in the colours shown in the palette. H base: 12 cm.

NOTE The model is equipped with a mechanism allowing the movement of backrest and footrest. This mechanism (push-arm) is easily operated by leveraging on the armrests and reclining the seat in your ideal p

STRUCTURE En bois, multiplies et particules habillée d'une couche de dacron.

REMBOURRAGE Coussin d'assise, accoudoirs et dossiers en polyuréthane expansé. Toutes les son couvertes par une couche de dacron ignifugé.

Assise en polyuréthane expansé densité 30 kg/m3 couvert par une couche de dacron ignifugé de 200 gr/m2.

Accoudoirs en polyuréthane expansé densité 30 kg/m3 couvert par une couche de dacron ignifugé de 200 gr/m2.

Dossiers en polyuréthane expansé densité 23 kg/m3 couvert par une couche de dacron ignifugé de 200 gr/m2.

Rembourrage de complément : densité 21 kg/m3.

RETEMENT Cuir ou microfibre non déhoussable. Pour les caractéristique du revêtement aussi bien que pour l'entretien veuillez consulter la fiches techniques appropriés.

PIEDS Le fauteuil est équipé avec une base pivotante circulaire en acier, disponible dansles couleurs en palette. H 12 cm.

NOTE Le modèle est doté d'un mécanisme de mouvement combiné pour dossier et repose-pieds. Ce mécanisme (push-arm) est facilement actionné en appuyant sur les accoudoirs afin d'incliner le siège dans votre emplacement idéal. Blues est seulement réalisable avec mécanisme manuel.

cod. 0129
POLTRONA GIREVOLE RELAX

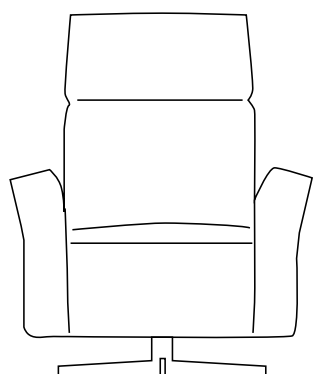

84

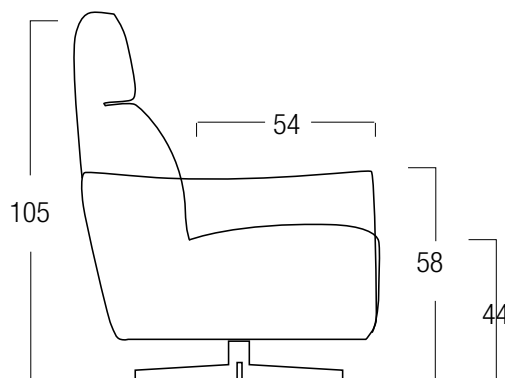

90

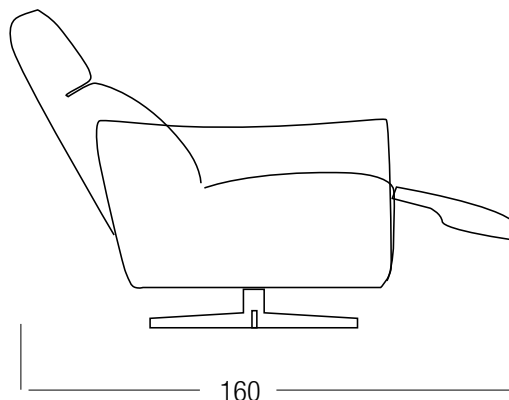

160

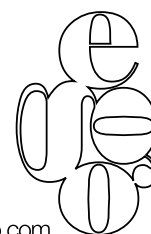

STRUTTURA Realizzata in legno abbinato a particelle di legno grezzo biodegradabile e pannelli di fibra di legno duro.

IMBOTTITURE Cuscini di seduta, poggiatesta, spalliere poggiatesta reclinabili e fianchi laterali sono realizzati in poliuretano espanso a densità differenziate e sono ricoperti da una doppia termofalda di dacron.

Cuscini di seduta: densità 30 kg/mc. Doppia termofalda di dacron, da 200 gr/mq e 350 gr/mq.

Poggiatesta e poggiatesta: densità 23 kg/mc. Termofalda di dacron da 350 gr/mq.

Fianchi laterali: densità 21 kg/mc. Doppia termofalda di dacron da 200 gr/mq.

Imbottiture di completamento: densità 21 kg/mc.

RIVESTIMENTO Pelle, tessuto o microfibra. Per le caratteristiche del rivestimento e della manutenzione vedere relative schede tecniche.

PIEDI In ABS da cm 3

NOTE Nella versione relax il modello è dotato esclusivamente di doppio meccanismo elettrico con comandi touch sensor posizionati nello spazio interno tra seduta e fianco laterale. I comandi possono agire indipendentemente tra di loro variando solo l'inclinazione della testiera oppure permettendo di distendere solo le gambe offrendo infinite possibilità di comfort. Nelle versioni fisse senza meccanismo relax in ogni caso è presente il cricchetto manuale nelle testiere.

FRAME Hard wood combined with plywood and particle board covered with a Dacron layer.

PADDING Seat cushion, armrest, kidney rest and headrest: double density polyurethane foam covered with a Dacron layer.

Seat cushion: polyurethane foam 30kg/m3.

Dacron layer: 200 gr/m2 and 350 gr/m2

Backrests and Kidney rests: polyurethane foam 23kg/m3.

Dacron layer 350 gr/m2

Finishing sides: polyurethane foam 21kg/m3

Frame padding: 21 kg/m3

COVERING Leather, microfibre or fabric. Not removable. Please check covering details for care instructions.

FEET In ABS 4 cm

NOTE In the relax version the model is equipped exclusively with double electrical mechanism with touch button controls positioned on the seats sides. The controls can act independently of each other by varying only the tilt of the headrests or allowing to stretch only the footrests thus allowing many different comfort positions. The relax elements are always separated from the fixed ones and are hooked together with an appropriate bayonet system. Fixed versions without relax mechanism are always equipped with adjustable manual headrests.

STRUCTURE En bois massif, multiplis et particules habillées d'une couche de dacron.

REMBOURRAGE Coussins d'assise, cale-reins, accoudoirs et appuie-tête réclinables réalisés en polyuréthane écologique à double densité recouvert avec une couche de dacron.

Coussins d'assise: Polyuréthane densité 30 Kg/m3. Recouvert d'une couche de Dacron 200 gr/m2 et 350 gr/m2

Dossiers et Cale-reins: Polyuréthane densité 23 Kg/m3. Dacron 350 gr/m2

Côtés: densité 21 Kg/m3. Dacron 200 gr/m2

Rembourrage de complément: densité 21 Kg/m3

REVETEMENT Cuir ou microfibre non déhoussable. Pour les caractéristique du revêtement aussi bien que pour l'entretien veuillez consulter les fiches techniques appropriés.

PIEDS En ABS cm 3

NOTE Dans les versions avec relax le modèle est équipé exclusivement d'un mécanisme électrique double moteur ayant son clavier touch sensor (touche tactile) insérés sur le côté des assises. Les commandes peuvent agir indépendamment les uns des autres en faisant varier seulement l'inclinaison de la tête ou des repose pieds, permettant de nombreuses positions de confort. Les éléments avec relax sont toujours séparés de ceux fixes et sont accrochés avec le système à baïonnette appropriée. Dans la version fixe sans mécanisme de relaxation les têtes sont en tout cas équipées avec mécanique manuelle.

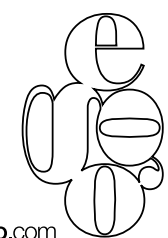
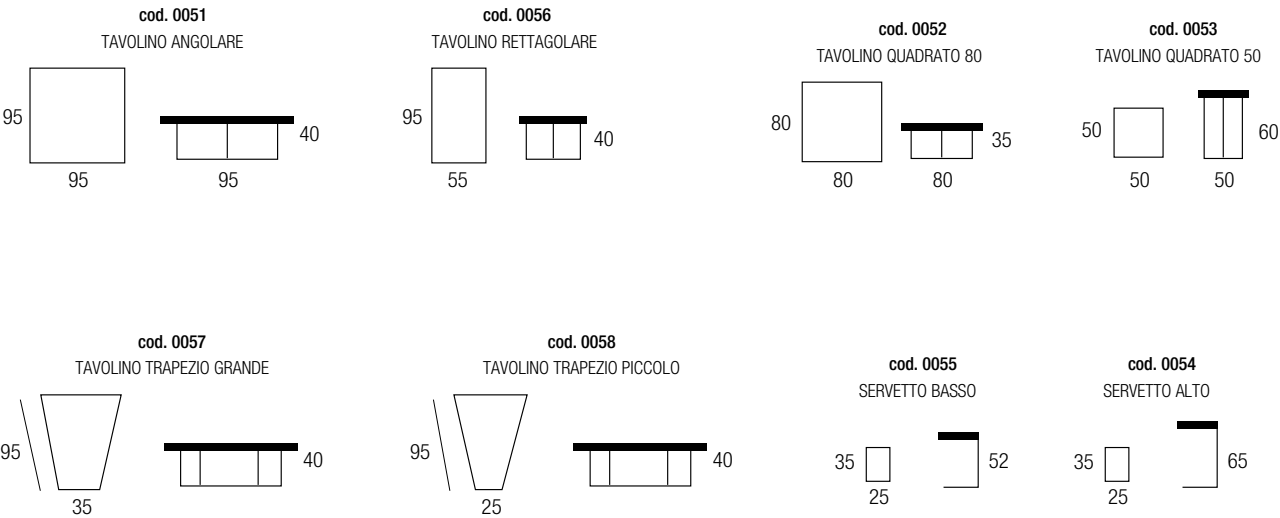
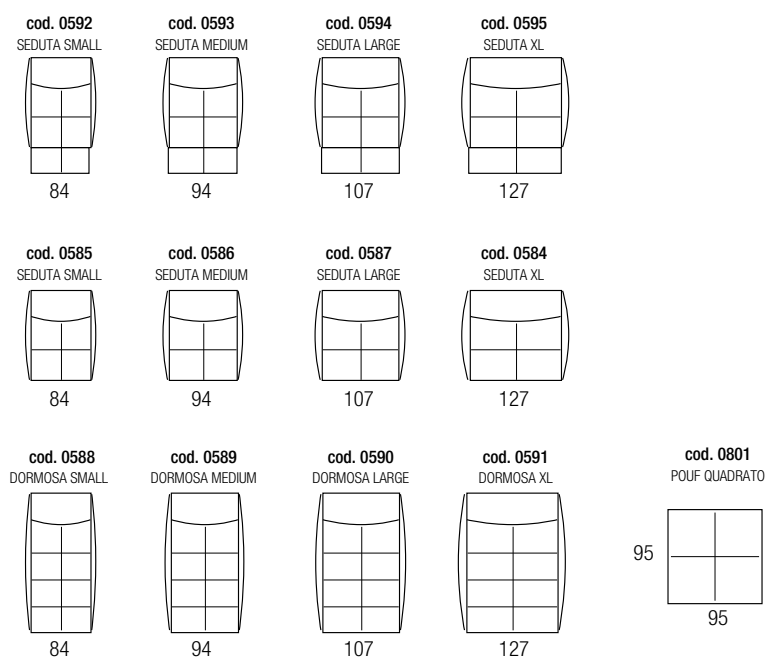
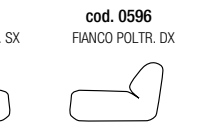
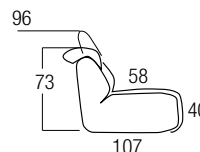

STRUTTURA Realizzata in legno abbinato a particelle di legno grezzo biodegradabile e pannelli di fibra di legno duro.

IMBOTTITURE Sedute, elementi di sostegno mobili e cuscini con rullo sono realizzati in poliuretano espanso a densità differenziate. Tutte le parti sopraelencate sono ricoperte da una termofalda di dacron autoestinguente.

Sedute: densità 35 kg/mc. Termofalda da 200 gr/mc.

Elementi di sostegno mobili: densità 30 kg/mc. Termofalda da 200 gr/mq.

Cuscini con rullo: densità 23 kg/mc. Termofalda da 450 gr/mq. Rullo: densità 40 kg/mc. ricoperto da una termofalda di dacron da 100 gr/mq.

Imbottiture di completamento: densità 21 kg/mc.

RIVESTIMENTO Pelle, tessuto o microfibra non sfoderabile. Per le caratteristiche del rivestimento e della manutenzione vedere relative schede tecniche.

PIEDI L'Ego: Sferici in legno massello con inserto in metallo, nelle finiture in legno e nei colori RAL previsti sulle palette disponibili. H alla base del divano: cm 12,5

L'Ego 2: slitta in metallo, realizzabile nei colori RAL previsti sulle palette disponibili. H alla base del divano: cm 12,5

NOTE Il divano è caratterizzato da spalliere mobili che possono essere posizionate in maniera diversa secondo le configurazioni desiderate. Dal design moderno, funzionale e versatile, L'Ego può essere utilizzato anche come comodo letto occasionale.

Il divano è disponibile in diverse configurazioni: dalla 3x3 alla 3x8, dalla 4x4 alla 4x8 per adattarsi a ogni esigenza di spazio.

FRAME Hard wood combined with plywood and particle board covered with a Dacron layer.

PADDING Seat cushion, movable backrests, and cushions with rolls in double density polyurethane foam covered with a Dacron layer.

Seat cushion: polyurethane foam 35kg/m3. Dacron layer: 200gr/m2

Movable Backrests: polyurethane foam 30kg/m3. Dacron layer 200 gr/m2

Cushions with rolls: polyurethane foam 23kg/m3. Dacron layer 450 gr/m2. Rolls: polyurethane foam 40kg/m3. Dacron layer 100 gr/m2

Frame padding: 21 kg/m3

COVERING Leather, microfiber or fabric. Not removable. Please check covering details for care instructions.

FEET

L'Ego: Spherical solid wood with metal insert. Available in the wood finishes and in the RAL colors provided on the palettes available. H at the base of the sofa: 12.5 cm

The Ego 2: metal sled, available in the RAL colors provided on the palettes available. H at the base of the sofa: 12.5 cm

NOTE The sofa is characterized by movable backs that can be positioned according to the desired configurations. With a modern, functional and versatile design, L'Ego can also be used as a comfortable occasional bed.

The sofa is available in different configurations: from 3x3 to 3x8, from 4x4 to 4x8 to adapt to any space requirement.

STRUCTURE En bois massif, multiplis et particules habillés d'une couche de dacron.

REMBOURRAGE Coussins d'assise, soutiens de dossier et coussins avec réalisés en polyuréthane écologique à double densité recouvert avec une couche de dacron.

Coussins d'assise: Polyuréthane densité 35 Kg/m3. Recouvert d'une couche de Dacron 200 gr/m2 Soutiens amovibles Dossiers : Polyuréthane densité 30 Kg/m3. Dacron 200 gr/m2.

Coussins avec rouleau: Polyuréthane densité 23 Kg/m3. Recouvert d'une couche de Dacron 450 gr/m2. Rouleau : Polyuréthane densité 40 Kg/m3. Recouvert d'une couche de Dacron 100 gr/m2.

Rembourrage de complément: densité 21 Kg/m3

REVETEMENT Cuir ou microfibre non déhoussable. Pour les caractéristique du revêtement aussi bien que pour l'entretien veuillez consulter les fiches techniques appropriés.

PIEDS

L'Ego: Bois massif sphérique avec insert en métal, dans les finitions en bois et dans les couleurs RAL indiquées sur les palettes disponibles. H à la base du canapé: 12,5 cm

L'Ego 2: en métal, disponible dans les couleurs RAL fournies sur les palettes disponibles. H à la base du canapé: 12,5 cm

NOTES Le canapé est caractérisé par des soutiens dossiers mobiles qui peuvent être positionnés selon les configurations souhaitées. Avec un design moderne, fonctionnel et polyvalent, l'Ego peut également être utilisé comme lit occasionnel confortable.

Le canapé est disponible dans différentes configurations: du 3x3 au 3x8, du 4x4 au 4x8 pour s'adapter à tous les besoins d'espace.

cod. 0570

MODULO 3X3

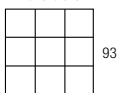

93

cod. 0571

MODULO 3X4

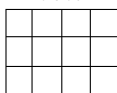

123

cod. 0572

MODULO 3X5

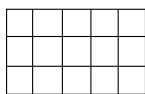

153

cod. 0573

MODULO 3X6

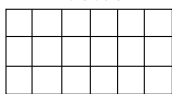

183

cod. 0574

MODULO 3X7

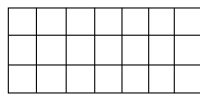

213

cod. 0575

MODULO 3X8

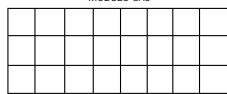

243

cod. 0576

MODULO 4X4

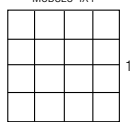

123

cod. 0577

MODULO 4X5

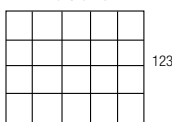

153

cod. 0578

MODULO 4X6

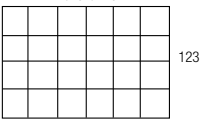

183

cod. 0580

MODULO 4X8

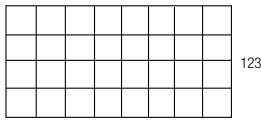

243

cod. 0579

MODULO 4X7

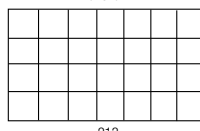

213

cod. 0581

ELEMENTO DI SOSTEGNO
SMALL

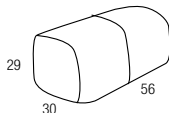

30

56

cod. 0582

ELEMENTO DI SOSTEGNO
MEDIUM

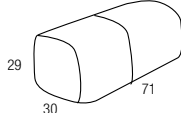

29

30

71

cod. 0583

ELEMENTO DI SOSTEGNO
LARGE

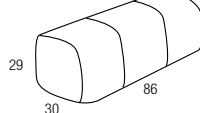

29

30

86

cod. 9991

CUSCINO CON RULLO

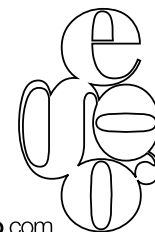

CAKEPOP - POUF TONDI

Rev. 04/2019

STRUTTURA Realizzata in legno abbinato a particelle di legno grezzo biodegradabile e pannelli di fibra di legno duro.

IMBOTTITURA Realizzata in poliuretano espanso a densità differenziate e ricoperta da una termofalda di dacron autoestinguente.

Seduta: densità 30 kg/mc.

Sponda: densità 23 kg/mc.

Termofalda: Dacron da 200 gr/mq, in doppio strato

RIVESTIMENTO Pelle, tessuto o microfibra non sfoderabile. Per le caratteristiche del rivestimento e della manutenzione vedere relative schede tecniche.

PIEDI in ABS da cm 2.

STRUCTURE Made of wood combined with biodegradable raw wood particles and hard wood fiber panels.

PADDING Made of polyurethane foam with different densities and covered with a self-extinguishing dacron layer.

Seat: polyurethane foam density 30 kg / mc.

Shore: polyurethane foam density 23 kg / mc.

Dacron layer: Dacron from 200 gr / mq, in double layer

COVERING Non-removable leather, fabric or microfiber. For the characteristics of the covering and maintenance see the relative technical data sheets.

FEET in ABS of 2 cm.

NOTE the larger Footstool, in addition to the fixed version with ABS feet, can be produced with a swivel base made of painted steel tube.

STRUCTURE Fait de bois combiné avec des particules de bois brutes biodégradables et des panneaux de fibres de bois dur.

REMBOURRAGE Fabriqué en mousse de polyuréthane de différentes densités et recouvert d'une couche en dacron auto-extinguible.

Seat: mousse de polyuréthane densité 30 kg / mc.

Shore: mousse de polyuréthane densité 23 kg / mc.

Couche en Dacron: à partir de 200 gr / mq, en double couche

REVETEMENT Cuir, tissu ou microfibre non déhoussable. Pour les caractéristiques du revêtement et de la maintenance, voir les fiches techniques correspondantes.

Pieds: en ABS de 2 cm.

NOTES le grand pouf, en plus de la version fixe avec pieds en ABS, peut être fabriqué avec une base pivotante en tube d'acier peint.

cod. 0824

LARGE

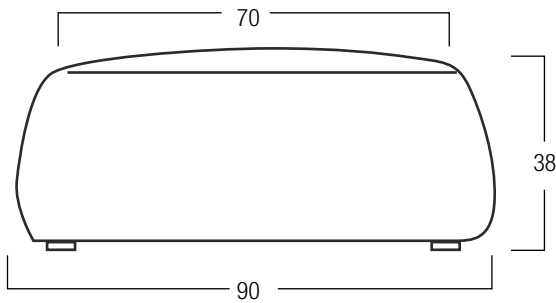

cod. 0825

SMALL

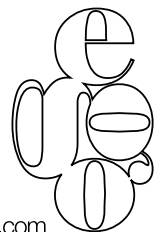
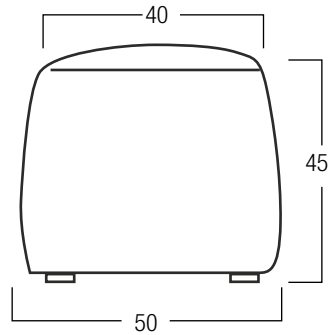

SELFY TAVOLINI

Rev. 04/2019

STRUTTURA In metallo finitura in vernici a polvere epossidica, con ripiano in legno disponibile nei colori Ral o finitura colore legno noce canaletto

FRAME In metal finished in epoxy powder paints, with wooden shelf available in Ral colors or finitura in canaletto walnut wood color

STRUCTURE En métal peint en poudre époxy, avec étagère en bois disponible en couleurs Ral ou finitura en couleur noyer canaletto

cod. 0051
TAVOLINO ANGOLARE

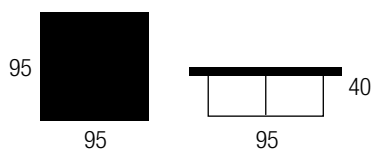

cod. 0056
TAVOLINO RETTAGOLARE

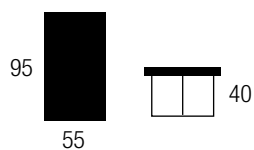

cod. 0057
TAVOLINO TRAPEZIO GRANDE



cod. 0058
TAVOLINO TRAPEZIO PICCOLO



cod. 0052
TAVOLINO QUADRATO 80

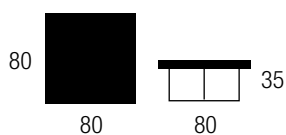

cod. 0053
TAVOLINO QUADRATO 50

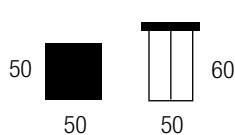

cod. 0055
SERVETTO BASSO

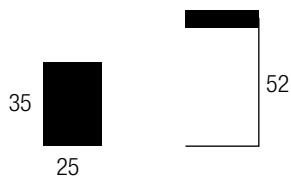

cod. 0054
SERVETTO ALTO

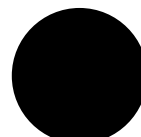
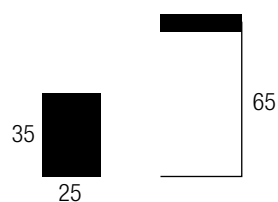

black

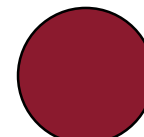

bordeaux
3005

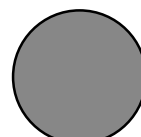

grey
7022

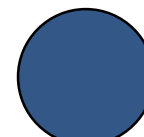

blu
5001

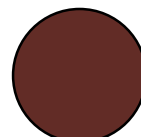

brown
8019

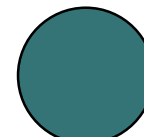

ottanio
5020

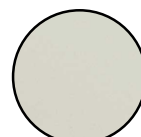

white
1013

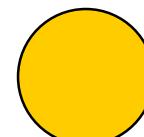

yellow
1005



NOCE
CANALETTO

